

**Drive solutions for
intralogistics and warehousing**
Complete drive systems from a single source



Complete drive solutions from a single source



NORD Delivers

NORD offers first-class customer service and support along with full-featured drive solutions that can tackle the toughest requirements. All components are carefully selected and precisely configured to meet your exact specifications. In the rare case that standard components won't meet your needs, our in-house engineering team will work with you to design custom components or a complete customized system.

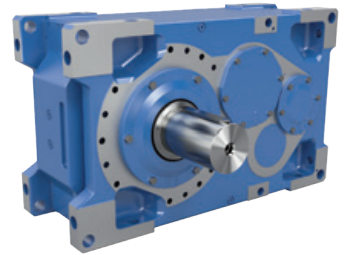

Reduce Lead Times and Decrease Inventory

- ▶ Fastest lead times in the industry with NO expedite fees
- ▶ Over 20,000,000 standard configurations to reduce or eliminate the need for custom components
- ▶ Modular drives, motors, and electronic controls minimize inventory of replacement units and parts



Global Product Designs, Standards, and Support

- ▶ Innovative, industry-standard products to support a wide range of applications
- ▶ Global sales and support network
- ▶ Dedicated mechanical and electrical application engineers ready to assist you
- ▶ Online resources available to you any time
- ▶ 24/7/365 emergency breakdown service

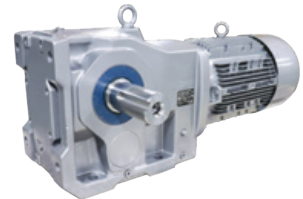

Increase Efficiency and Reduce Operation Costs

- ▶ myNORD online tools for fast selection, configuration, ordering, and tracking of your drive units
- ▶ Drive systems that are perfectly matched to your application for optimum performance and energy efficiency
- ▶ Program personalization, such as weekly shipment schedules and custom nameplates
- ▶ Partner with a company that is easy to do business with and wants to see you succeed!



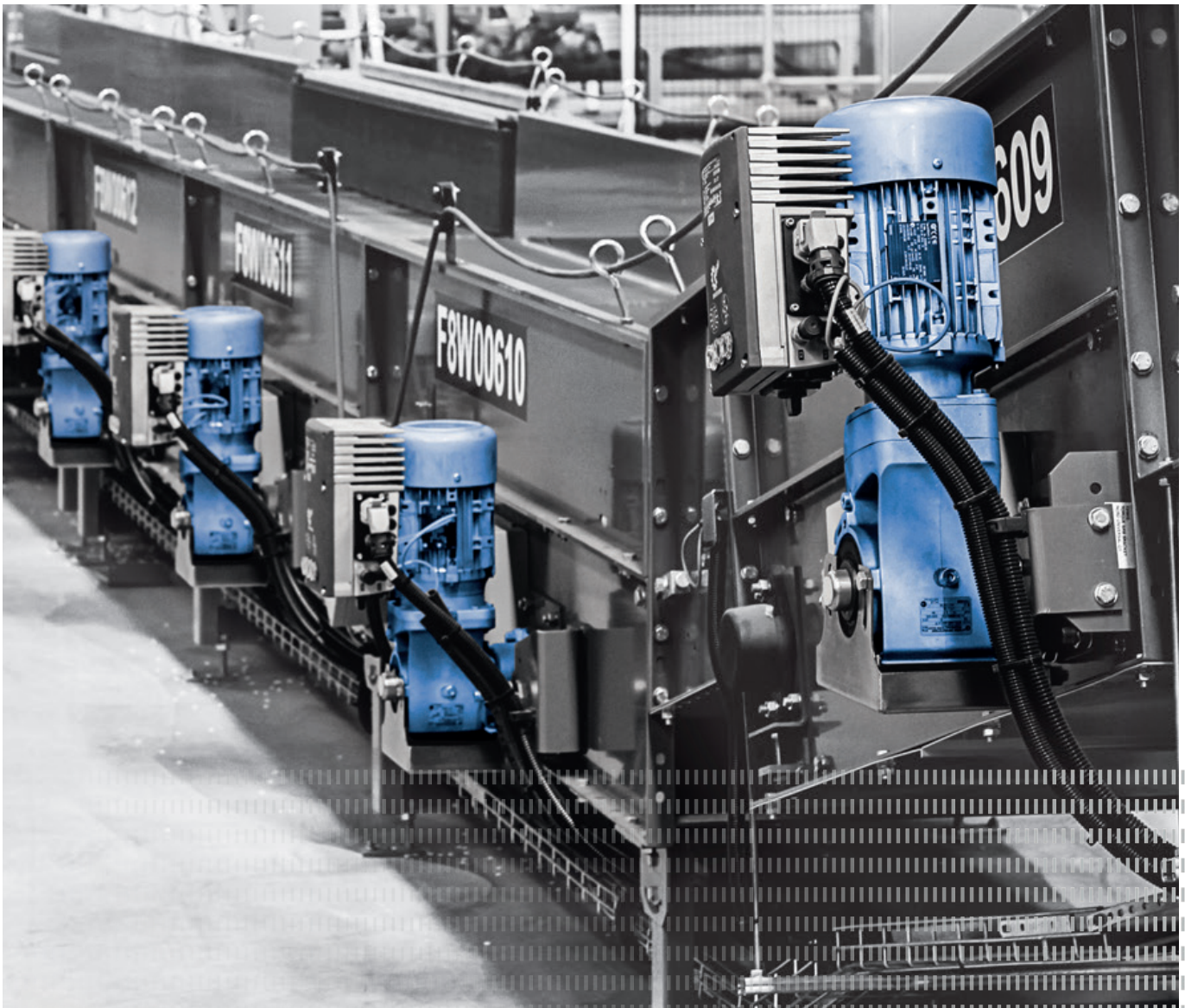

Integrated solutions for the special requirements of intralogistics handling

- ▶ Simple commissioning
- ▶ Global NORD network
- ▶ Plug-and-Play systems
- ▶ Easy maintenance and safe, reliable operation
- ▶ Lower total cost of ownership
- ▶ Standardization
- ▶ Energy savings
- ▶ Project and product support
- ▶ Modular design

Drive solutions for intralogistics and warehousing

1 Storage and retrieval devices

Automated storage systems with high storage density require agile stacker cranes for rapid retrieval and storage of goods. NORD's compact solutions give these cranes all of the control and performance needed within a small footprint.

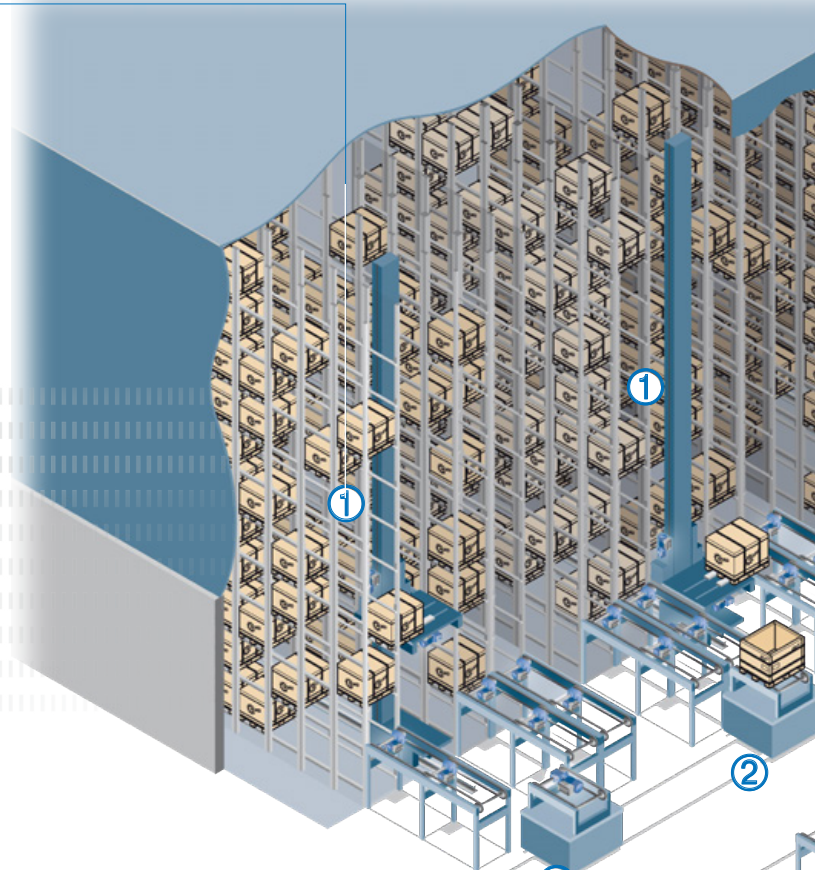

2 Transfer vehicles

NORD's drive solutions give automated transfer carts the precision they need to move loads from a conveyor belt to a defined location within the warehouse or distribution center.

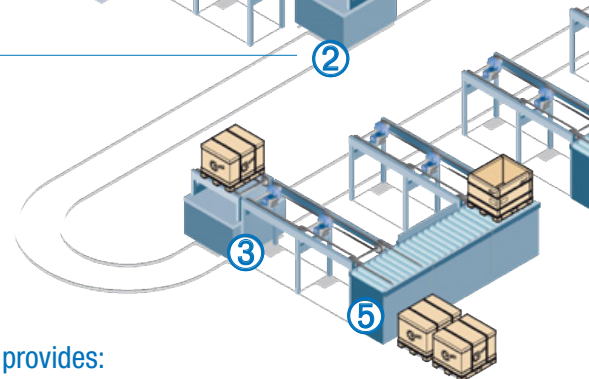

NORD DRIVESYSTEMS is one of the world's leading drive technology manufacturers. Our industry-specific, innovative drive solutions are used throughout the world for a wide variety of applications in the intralogistics and warehousing industries.

NORD DRIVESYSTEMS provides:

- ▶ Extensive knowledge of applications and technical support
- ▶ Complete drive solutions from a single source
- ▶ Strong global presence and service
- ▶ Thousands of installed drives in the intralogistics industry
- ▶ Wide range of products with high quality standards
- ▶ Great reliability, economy, and service life
- ▶ Recognized product quality that is compliant with international standards

3 Chain conveyors

Robust drive solutions with high overload capacity, long service life, and low maintenance effectively power chain conveyors that transport heavy loads and industrial containers.

5 Corner transfer conveyor

Intelligent electronic control products and high efficiency gear units enable roller and chain power turn conveyors to smoothly change load direction.

4 Roller conveyors

NORD's light, compact, and intelligent drive solutions precisely control individual roller conveyors for an Industry 4.0 solution.

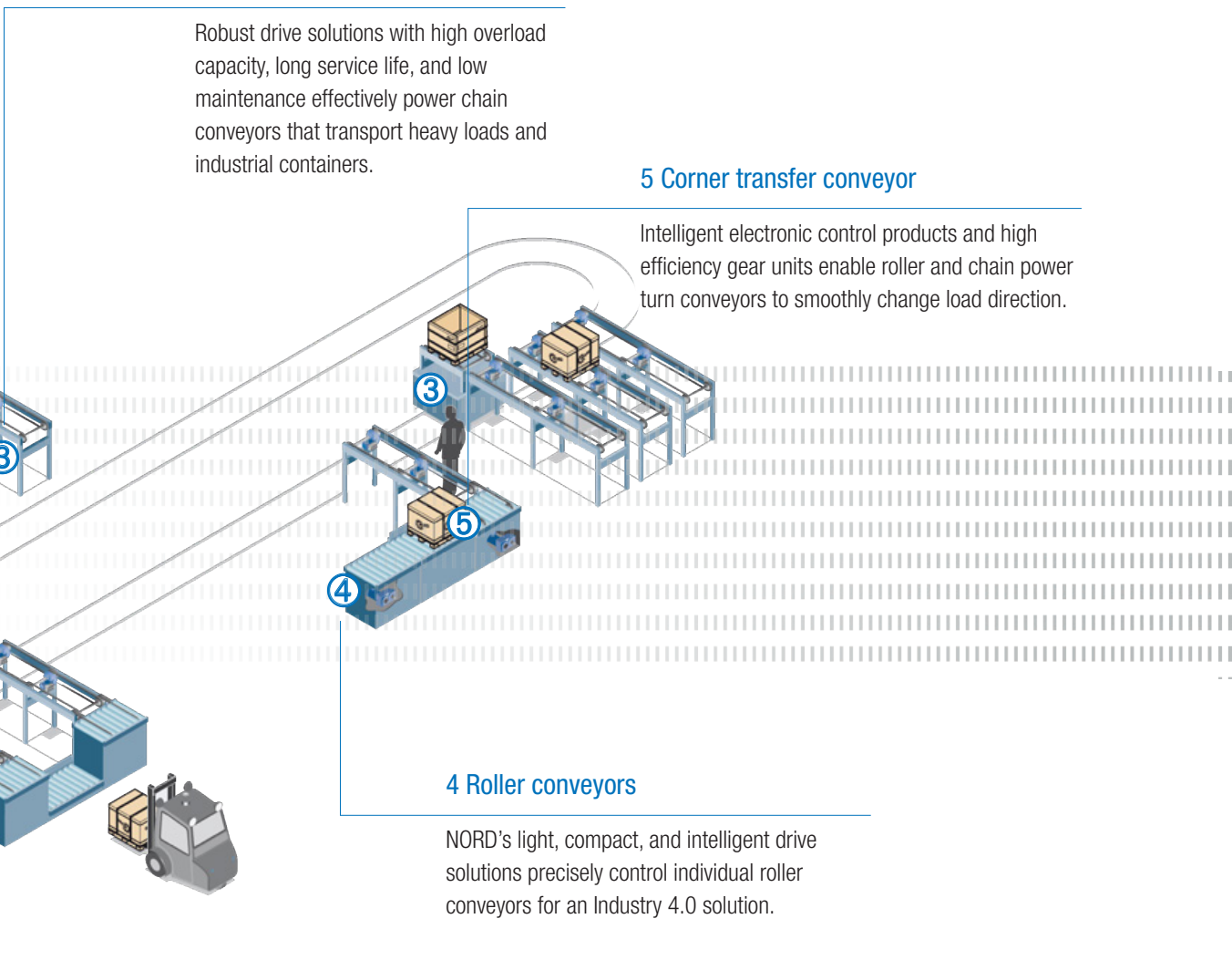
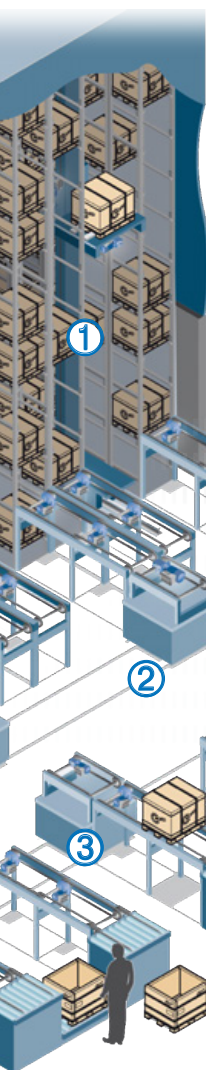

We support you with:

Design

- ▶ myNORD online tools
- ▶ Version reduction
- ▶ Project design / optimization
- ▶ Drive system design
- ▶ Application solutions
- ▶ Green solutions
- ▶ CAD drawings
- ▶ TCO/ROI calculations
- ▶ Efficiency optimization

Commissioning

- ▶ Plug-and-Play
- ▶ Support
- ▶ Training
- ▶ Documentation
- ▶ Fast, easy commissioning

Service

- ▶ Predictive maintenance (integrated PLC function)
- ▶ Spare parts, fast shipping
- ▶ Global presence
- ▶ 24/7/365 emergency support

Drive solutions for intralogistics and warehousing

NORD DRIVESYSTEMS develops and manufactures scalable drive solutions for all areas of the logistics industry.

NORD DRIVESYSTEMS developed the revolutionary UNICASE™ gear unit housings in the early 1980's. These fully enclosed housings combine all of the gear unit's components and is machined from a single piece of material.

- ▶ Housing block integrates all bearing points
- ▶ Complete machining in a single step
- ▶ High output torque
- ▶ High axial and radial loads
- ▶ Ultimate reliability
- ▶ Long service life
- ▶ Quiet operation

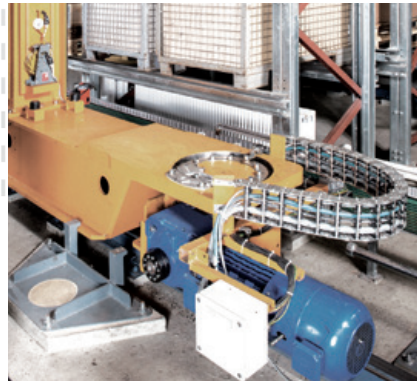

Storage and retrieval devices

To achieve a high degree of mobility and throughput, storage and retrieval systems depend on NORD's dynamic, reliable drives and electronic controls.

- ▶ Dynamic
- ▶ Easy to service and maintain
- ▶ Precise positioning
- ▶ Energy-efficient
- ▶ DC link in VFD



Transfer trolleys & transport vehicles

NORD drives ensure that loads are positioned precisely for rapid, smooth transfer to a defined location within a warehouse.

- ▶ Compact design
- ▶ Fast, easy installation
- ▶ Precise positioning
- ▶ Integrated PLC function

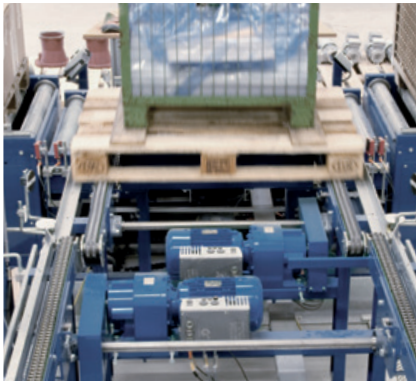
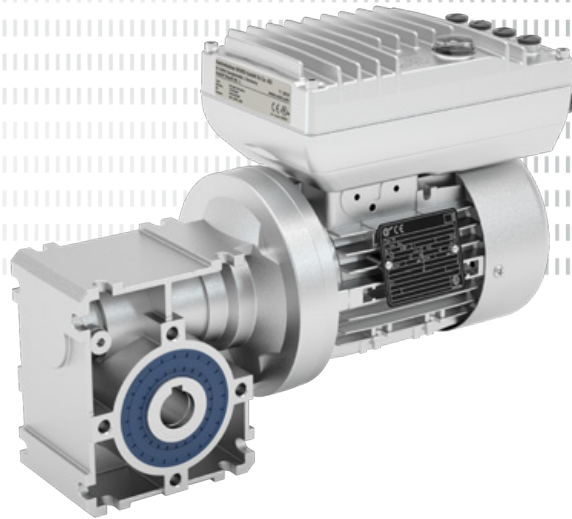

Chain conveyors

When transferring loads, especially those that are extremely heavy, chain conveyors require robust gear units to operate. NORD drives have proven long service life – both in single and double line configurations, giving you the power and longevity you need.

- ▶ Compact design
- ▶ Low maintenance
- ▶ Reduction of variants
- ▶ High overload capacity
- ▶ High power density



Roller & belt conveyors

NORD drives can be individually controlled to intelligently adjust the speed on the line. This allows for precise, dynamic control of distances and accumulation of packing units.

- ▶ Small footprint
- ▶ Reduced TCO
- ▶ High radial and axial load capacity
- ▶ Standardized solutions to reduce inventory and maintenance costs

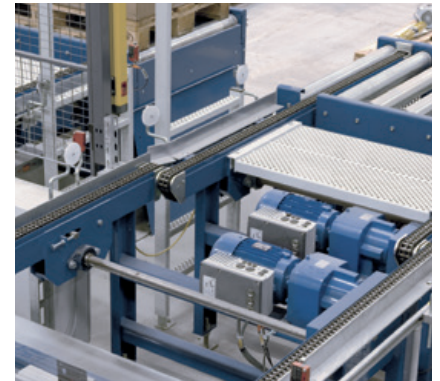

Corner transfer conveyors

Drive solutions from NORD efficiently control rollers and chains within a power turn conveyor system to smoothly and accurately change direction of the load.

- ▶ Compact design
- ▶ Modular construction
- ▶ High output torque
- ▶ High system efficiency

Drive solutions for intralogistics and warehousing

Efficient, reliable, and proven drive solutions from a single source



Efficient

NORD drive solutions are environmentally friendly and help to minimize CO₂ emissions.

- ▶ Motors with low mass inertia are designed for VFD operation and are in compliance with the latest international energy requirements.
- ▶ NORD variable frequency drives ensure efficient operation, improved process control, and optimized motor performance.
- ▶ Easy to service and maintain, NORD drives reduce standstill times and contribute to an increased efficiency and availability of the entire system.

Reliable

It is vital to prevent unplanned downtime of intralogistics systems. For this reason, reliability is our main focus when developing drive solutions. All of our system components are precisely matched to each other and ensure smooth, reliable operation.

- ▶ UNICASE™ gear units ensure precise positioning of bearings and shafts.
- ▶ AUTOVENT™ ensures a leak-free design.
- ▶ Precisely machined gear wheels resulting in minimal wear.
- ▶ Gear units that are extraordinarily robust, run quietly, and have a long service life.
- ▶ NORD VFDs electronically protect the drive system and can visualize operating data.

Tried-and-tested

The reliability and cost-effectiveness of electronically controlled NORD conveyor drives have proven themselves in intralogistics throughout the world. These systems combine high flexibility and tiered functionality with convenient operation. NORD drives also ensure high conveyance speeds that are often required due to increased safety measures.

- ▶ Mechatronic drive solutions from NORD DRIVESYSTEMS are based on 2-stage bevel gear units featuring low weights and high efficiencies.
- ▶ In combination with wall-mounted or motor-mounted variable frequency drives, NORD gear units form intelligent, highly efficient drive systems. NORD also supplies the required cable connectors and interfaces for a variety of bus systems as well as their respective software.
- ▶ NORD variable frequency drives have solutions for both cabinet mount and decentralized applications.

LogiDrive®

The ideal solution for intralogistics technology

- ▶ Highly efficient 2-stage bevel gear unit
- ▶ IE4 or IE5+ PMSM synchronous motor
- ▶ Power plug connector
- ▶ Signal connector
- ▶ Incremental encoder
- ▶ Pre-assembled cable
- ▶ High overload capacity



The LogiDrive solution from NORD DRIVESYSTEMS reduces planning and commissioning effort

- ▶ NORD VFDS for intralogistics applications can control both synchronous and asynchronous motors
- ▶ Simple planning with identical housing dimensions for synchronous and asynchronous motors

NORDAC LINK FDS* SK 250 *field distribution system

- ▶ Internal or external braking resistor
- ▶ External 24 V DC supply for the control board, this ensures the same potential for all drive units. The drive units can be accessed via the bus even without the 400 V AC main voltage, as the control board remains active due to the 24V DC supply.
- ▶ Decentralized installation
- ▶ Plug-in EEPROM, data can be transferred if servicing is required

IE5+ synchronous motors

The use of IE5+ synchronous motors minimizes overall costs during service life, achieves considerably greater efficiency, and provides a faster return on investment (ROI). IE5+ motors unfold their full potential in applications with partial load ranges and low speed ranges.

Efficiency at full load and partial speed

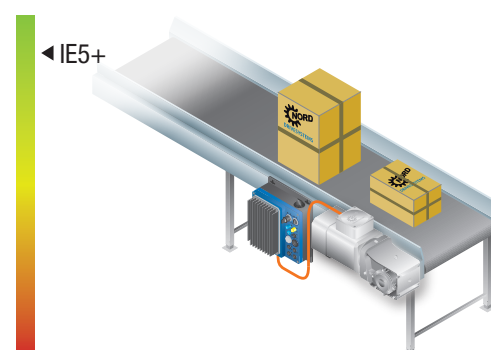
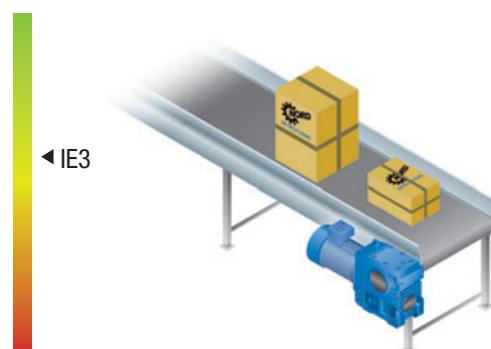









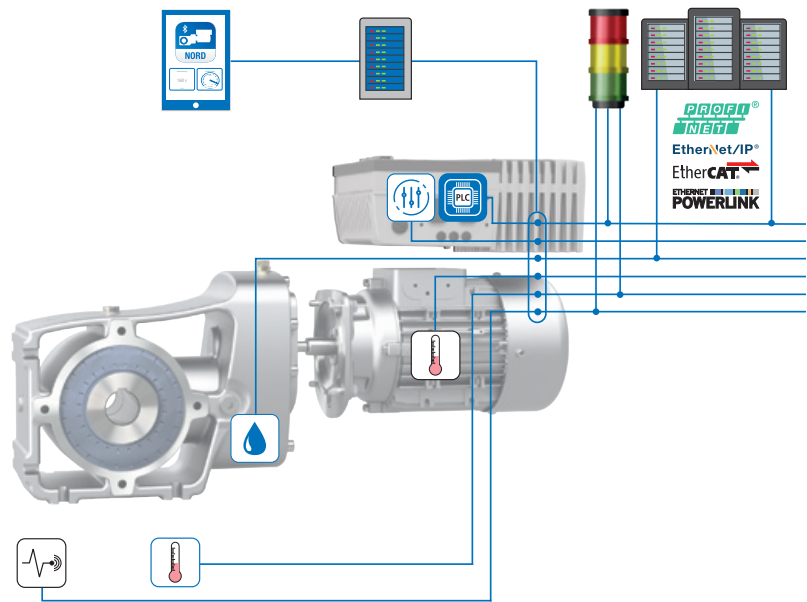

Motor size	IE3	IE5+
71	0.33 - 0.5 hp	0.5 - 3.0 hp
80	0.75 - 1.0 hp	0.5 - 3.0 hp
90	1.5 - 2.0 hp	1.5 - 4.0 hp
100	3.0 - 4.0 hp	1.5 - 5.0 hp

Drive solutions for intralogistics and warehousing

For condition monitoring, operating and status data are regularly or continuously recorded in order to optimize the reliability and efficiency of facilities and machinery. Important information for predictive maintenance can be derived from the data analysis.

The objective is to maintain machines and facilities proactively, reducing downtimes and increasing overall operational efficiency.



- System vibration sensor 
 - ▶ NORD qualified sensors
 - ▶ Customer-specific sensors can be connected (analog/digital)
- Temperature sensor 
 - ▶ Motor temperature sensor on the basis of PT1000
 - ▶ Ambient or system temperature
- Oil change 
 - ▶ Determination of the optimum time for oil change on the basis of the virtual oil temperature
 - ▶ Algorithm is executed in the internal PLC
- Drive parameters 
 - ▶ Read-out of the drive parameters of the drive system
 - ▶ Basis for virtual sensors
- Integrated PLC 
 - ▶ Pre-processing of drive-specific parameters and drive-related sensors
 - ▶ Evaluation of drive condition
- Signal beacon 
 - ▶ Local display of drive condition
 - ▶ Scalable display
- Local data management 
 - ▶ Processing of drive data for drive and system analysis
 - ▶ Condition monitoring
- Local dashboard 
 - ▶ Display of drive and system data
- Higher level PLC 
 - ▶ Processing of condition monitoring information by the customer
 - ▶ Combination of the collected condition monitoring information with the process data

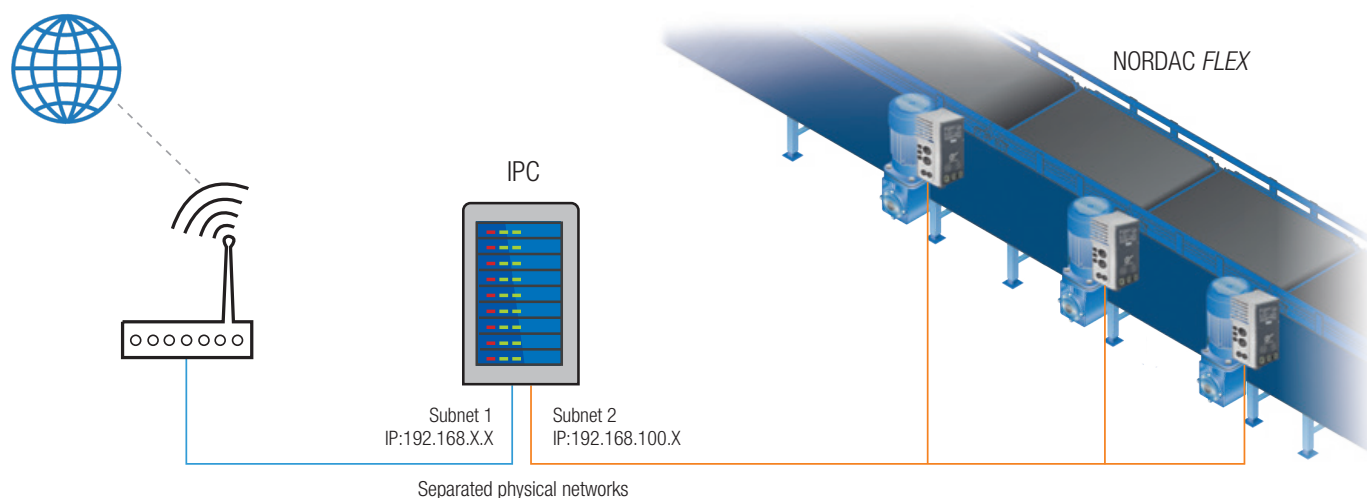

Condition monitoring in a parcel distribution center

NORD supplied a software solution for a parcel distribution center to upgrade their existing system with condition monitoring functionality. By adding an Industrial PC (IPC), it became possible to collect all drive information parameters and forward it to a customer cloud. The system is equipped with 96 NORD drives, consisting of gear units, motors, and variable frequency drives from the NORDAC *FLEX* series. PROFINET IO was used as the communication interface. In addition to participants on the PROFINET network, up to three participants could be connected to a VFD via the system bus. The IPC was subsequently installed in a control cabinet.

In addition to a cybersecurity concept using Windows firewall, Windows security updates, and an antivirus program, the IPC is equipped with two physically separated network cards. One is the interface to the customer application via which the drive data is collected. The other provides the interface to the customer cloud. This makes the system highly secure.

The IPC queries all previously defined parameters from all variable frequency drives via the UDP channel of the PROFINET IO telegram. Additionally, the local database is protected by HTTPS, a user name, and a password.

The following drive information parameters are collected:

- ▶ Operating time
- ▶ Running time
- ▶ Actual speed
- ▶ Actual current
- ▶ Actual voltage
- ▶ Mechanical power
- ▶ Heat sink temperature of the variable frequency drive

The data is stored in the database on the local IPC. After this, a push function enables the data to be directly transferred into a customer cloud. This solution enabled the customer to seamlessly integrate condition monitoring for predictive maintenance into their existing system.

Drive solutions for intralogistics and warehousing

NORDAC ON / ON+ – strong focus, optimum function

NORDAC ON/ON+ decentralized variable frequency drives were designed to meet the special requirements of horizontal conveyor technology. The NORDAC ON has been developed for IE3 motors while the NORDAC ON+ has been optimized for the combination with IE5+ synchronous motors. The variable frequency drives are characterized by an integrated Ethernet interface, full Plug-and-Play capabilities, and compact design for IIoT environments.

Features

- ▶ Power range: 0.5 - 1.27 hp
- ▶ Protection class: IP55, IP66
- ▶ Wall or motor mounting
- ▶ Multi-protocol Ethernet interface
- ▶ Reduction of variants
- ▶ Plug-and-Play solution for fast commissioning

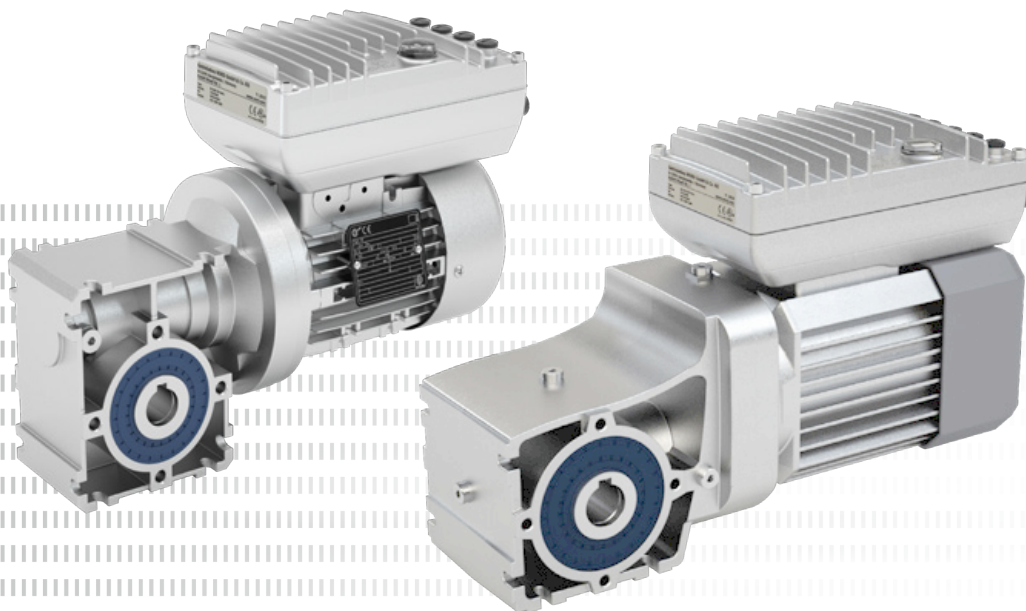

Motor	Frame size 1	Frame size 2	Frame size 3
63 LP/4 – 2,600 rpm	11 lb-in – 0.42 hp – 1.2 A	11 lb-in – 0.42 hp – 1.2 A*	
71 SP/4 – 2,600 rpm	15 lb-in – 0.58 hp – 1.5 A	15 lb-in – 0.58 hp – 1.5 A*	
71 LP/4 – 2,600 rpm		22 lb-in – 0.86 hp – 1.9 A	
80 SP/4 – 2,600 rpm		32 lb-in – 1.27 hp – 2.2 A	
ASM 90 – 2,600 rpm			In preparation

*Greater powers in 87 Hz can be equipped with NORDAC FLEX until Frame size 3 is available.

The new DuoDrive with integrated IE5+ synchronous motor delivers a new era of energy efficiency and easy system maintenance.

- ▶ Extremely high system efficiency of up to 92%
- ▶ Reduced Total Cost of Ownership (TCO) and fast Return on Investment (ROI)
- ▶ Variant reduction through constant motor torque over a wide speed range
- ▶ Compact, wash-down design for easy installation and optimized space utilization
- ▶ Industry-standard mounting dimensions
- ▶ Very quiet operation

Features

- ▶ Latest generation permanent magnet synchronous motor (PMSM) integrated in a single-stage helical in-line gear unit housing
- ▶ Power range from 0.5 to 2 hp in a single frame size
- ▶ Flexible attachment options:
 - ▶ B5 flange (160 mm diameter)
 - ▶ B14 flange (160 or 200 mm diameter)
 - ▶ Torque arm, shrink disc, and GRIPMAXX™
- ▶ Wide variety of motor connectivity options such as HANQ8 / HAN10E plug connectors, circular connectors, or directly wired
- ▶ Optional holding brake and integrated encoder system

Perfect system solution combined with NORD drive electronics

- ▶ NORDAC *PRO* for control cabinet installations, NORDAC *LINK*, *FLEX*, and *ON+* for decentralized and wall mounting installations
- ▶ Suitable system wiring:
 - ▶ Motor connection
 - ▶ Mains supply
 - ▶ Signal connection
- ▶ Together with perfectly matched drive electronics, NORD DuoDrive is the perfect solution for high power requirements and outstanding system efficiency



Drive solutions for intralogistics and warehousing

DuoDrive (Catalog G5010)



- ✓ Integrated gear unit and motor
- ✓ Extremely high system efficiency
- ✓ Compact, space saving design
- ✓ High power density

Sizes: 2
Power: 0.5 – 4 hp
Torque: Up to 2,186 lb-in
Ratio: 3.24:1 – 18.1:1

UNICASE™ helical gear units (Catalog G1000)



- ✓ Foot or flange mounted
- ✓ Long life, low maintenance
- ✓ Closely stepped ratios
- ✓ Cast-iron UNICASE housing

Sizes: 11
Power: 0.16 – 215 hp
Torque: Up to 230,000 lb-in
Ratio: 2.76:1 – 14,340.31:1

CLINCHER™ parallel shaft gear units (Catalog G1000)



- ✓ Foot, flange, or shaft mounted
- ✓ Hollow or solid shaft
- ✓ Compact design
- ✓ Cast-iron or aluminum UNICASE housing

Sizes: 15
Power: 0.16 – 268 hp
Torque: Up to 885,000 lb-in
Ratio: 4.03:1 – 15,685.03:1

NORDBLOC.1® 2-stage bevel gear units (Catalog G1014)

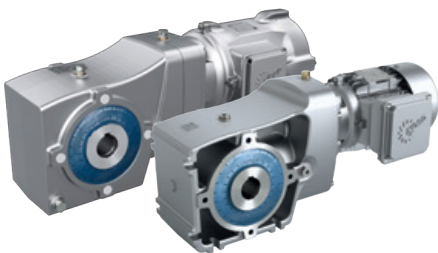

- ✓ Foot, flange, or shaft mounted
- ✓ Hollow or solid shaft
- ✓ Aluminum housing
- ✓ Compact design

Sizes: 6
Power: 0.16 – 12.5 hp
Torque: Up to 5,800 lb-in
Ratio: 3.03:1 – 70:1

FLEXBLOC® worm gear units (Catalog G1035)



- ✓ Modular aluminum housing
- ✓ Universal mounting design
- ✓ Life-long lubrication
- ✓ NEMA or IEC input versions

Sizes: 5
Power: 0.16 – 5.5 hp
Torque: Up to 3,780 lb-in
Ratio: 5.00:1 – 3,000.00:1

NORDAC® ON/ON+ variable frequency drives (Catalog E3000)

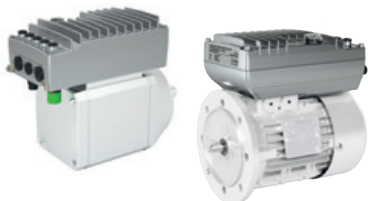

- ✓ Wall or motor mounted
- ✓ Ethernet communication
- ✓ Compact design
- ✓ Plug-and-Play solution

Sizes: 2
Voltage: 3~ 400V
Power: 0.5 – 1.27 hp

SK 135E NORDAC® START motor starters (Catalog E3000)



- ✓ Integrated electronic brake rectifier
- ✓ Consistent parameter structure
- ✓ Reversing starter with soft start function

Sizes: 2
Voltage: 3~ 200 – 240 V, 3~ 380 – 500 V
Power: 0.16 – 4 hp or up to 10 hp

SK 200E NORDAC® FLEX variable frequency drives (Catalog E3000)



- ✓ Energy saving function
- ✓ Integrated POSICON positioning control
- ✓ Integrated PLC

Sizes: 4
Voltage: 1~ 110 – 120 V, 1~ 200 – 240 V, 3~ 200 – 240 V, 3~ 380 – 500 V
Power: 0.33 – 30 hp

SK 250E NORDAC® LINK field distributors (Catalog E3000)



- ✓ Variable frequency drive or motor starter
- ✓ PLC functionality for drive-integrated functions
- ✓ All connections in plug-in version for easy commissioning and maintenance

Sizes: 3
Voltage: 3~ 380 – 500 V
Power: VFD 0.75 – 10 hp; Motor starter 0.16 – 4 hp

Motors (Catalog M7000)



- ✓ IE3 motors from 0.16 hp (Size 63)
- ✓ IE5+ synchronous and asynchronous motors

International energy efficiency standards

- ▶ EU: IE1 – IE5+ as + per IEC 60034-30
- ▶ US: ee labeling as per EISA 2007 (Dept. of Energy)
- ▶ CA: CSA energy verified as per EER 2010
- ▶ CN: CEL as per GB 18613
- ▶ KR: KEL as per REELS 2010
- ▶ BR: Alto Rendimento as per Decreto nº 4.508
- ▶ AU: MEPS as per AS/NZS 1359.5

NORDAC® ACCESS BT (Flyer S9090)



- ✓ Stand-alone parameter memory
- ✓ Bluetooth interface for VFDs and NORDCON APP
- ✓ Data transfer to PC via USB
- ✓ Can be plugged in or disconnected during operation

Ordering is Easy With myNORD Online Tools!

- ▶ Obtain drawing files direct from quote configuration
- ▶ Effortlessly select & configure customized drive solutions
- ▶ Create quotes with account-specific net pricing
- ▶ Order-specific documentation
- ▶ 24/7/365 order tracking
- ▶ Select and order spare parts



Register now at myNORD.com!

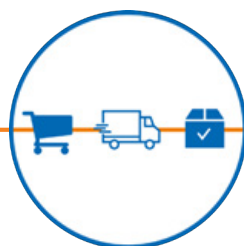
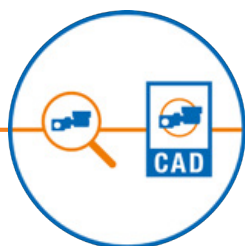

US

NORD Gear Corporation
 Waunakee, WI
 800 NORD Drive
 Waunakee, WI 53597
 Tel. 888.314.6673
info.us@nord.com
www.nord.com

Corona, CA
 1180 Railroad St.
 Corona, CA 92882
 Tel. 888.314.6673
info.us@nord.com

Charlotte, NC
 300E Forsyth Hall Dr.
 Charlotte, NC 28273
 Tel. 888.314.6673
info.us@nord.com

CA

NORD Gear Limited
 Brampton, ON
 41 West Drive
 Brampton, ON L6T4A1
 Tel. 800.668.4378
info.ca@nord.com

MX

NORD DRIVE SYSTEMS SA DE CV
 Queretaro, Mexico
 Av. Industria Textil B.6
 Parque Industrial PYME, Huimilpan
 QRO - Mexico 76950
 Tel. 52 442 688 7110
info.mx@nord.com