

INTELLIGENT DRIVESYSTEMS, WORLDWIDE SERVICES

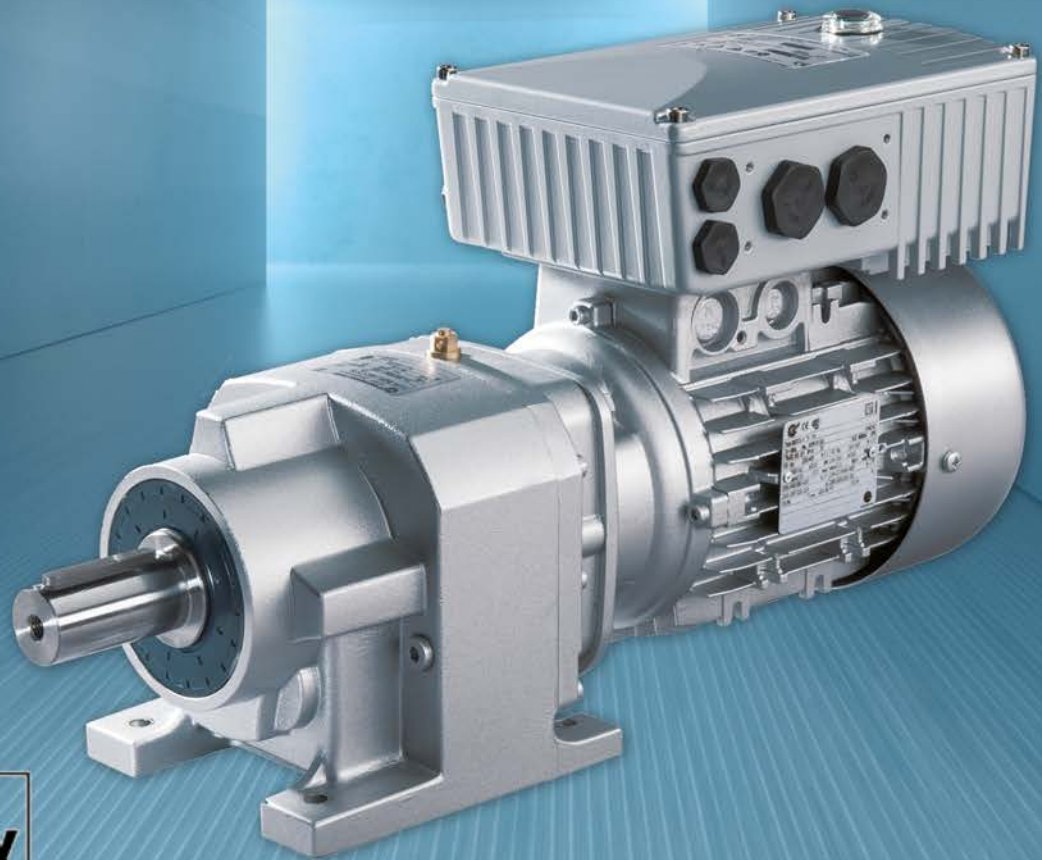

BU 0180 – en

**NORDAC BASE (SK 180E / SK 190E)**

Users Manual for Frequency Inverters



## Documentation

<b>Title:</b>	<b>BU 0180</b>
<b>Order no.:</b>	<b>6071802</b>
<b>Series:</b>	SK 1x0E
<b>Device series:</b>	SK 180E, SK 190E
<b>Device types:</b>	<i>SK 1x0E-250-112-O ... SK 1x0E-750-112-O</i> 0.25 – 0.75 kW,    1~ 110-120 V, Out: 230 V <i>SK 1x0E-250-323-B ... SK 1x0E-111-323-B</i> 0.25 – 1.1 kW,    1/3~ 200-240 V <i>SK 1x0E-151-323-B</i> 1.5 kW,    3~ 200-240 V <i>SK 1x0E-250-340-B ... SK 1x0E-221-340-B</i> 0,25 – 2,2 kW,    3~ 380-480 V

## Version list

Title, Date	Order number	Software version of device	Remarks
<b>BU 0180</b> , June 2013	<b>6071802</b> / 2313	V 1.0 R0	First issue.
<b>BU 0180</b> , February 2014	<b>6071802</b> / 0914	V 1.0 R1	Among others: <ul style="list-style-type: none"> <li>• General corrections</li> <li>• Bus options added</li> <li>• Adaptation of individual technical data</li> <li>• Device 1.5 kW, 3~ 230 V added</li> <li>• Revision of EMC section, incl. supplement of EC Declaration of Conformity</li> </ul>
<b>BU 0180</b> , June 2014	<b>6071802</b> / 2314	V 1.0 R1	Among others: <ul style="list-style-type: none"> <li>• General corrections</li> <li>• Correction of terminal names from "AGND ,12" to "GND/0V ,40"</li> </ul>
<b>BU 0180</b> , March 2015	<b>6071802</b> / 1115	V 1.0 R1	<ul style="list-style-type: none"> <li>• UL – group fuse protection</li> <li>• Braking resistor</li> </ul>
<b>BU 0180</b> , March 2015	<b>6071802</b> / 1315	V 1.0 R1	<ul style="list-style-type: none"> <li>• ATEX</li> </ul>
<b>BU 0180</b> , March 2016	<b>6071802</b> / 1216	V 1.2 R0	Among others: <ul style="list-style-type: none"> <li>• General corrections</li> <li>• Structural modifications to the document</li> <li>• New parameters: P240 – 247, 300, 310 - 320, 330, 331, 333, 350 – 370, 746</li> <li>• Adaptation of parameters: P001, 003, 105, 108, 109, 110, 200, 219, 401, 418, 420, 434, 480, 481, 502, 509, 513, 535, 740, 741</li> <li>• PMSM</li> <li>• PLC</li> <li>• IP69K</li> <li>• New presentation of scope of delivery / accessory overview</li> <li>• Revision of section "UL/cUL", including for CSA: voltage limitation filter no longer required (SK CIF) → Module removed from document</li> <li>• Revision of "Braking resistor" section</li> </ul>

			<ul style="list-style-type: none"> <li>• Display and operation → Connection of multiple devices to a parametrisation tool (tunnelling via system bus)</li> <li>• Commissioning → Selection of operating mode for motor control added</li> <li>• Revision of "Technical / Electrical Data"</li> <li>• Addition of an FAQ list for operational problems</li> <li>• Removal of detailed descriptions of accessories and reference to appropriate technical information</li> <li>• Update of EC/EU conformity declarations</li> </ul>
<b>BU 0180</b> , October 2018	<b>6071802</b> / 4118	V 1.2 R1	<p>Among others:</p> <ul style="list-style-type: none"> <li>• General corrections</li> <li>• Revision of safety information</li> <li>• Revision of warning information</li> <li>• Adaptations for ATEX, outdoor installation and braking resistors</li> <li>• Addition of EAC Ex</li> <li>• Revision of wall mounting kits and adapter kits for motor mounting</li> <li>• Adaptation of parameters: P300, 553, 543, 556, 557</li> <li>• Parameters: P331, 332, 333 without function, → deleted</li> <li>• Update of EC/EU conformity declarations</li> <li>• Addition of temperature sensors (PT100, PT1000)</li> <li>• Correction of standardisation of setpoint and actual values</li> <li>• Motor data extended with 100 Hz characteristic curve</li> </ul>
<b>BU 0180</b> , December 2020	<b>6071802</b> / 5020	V 1.3 R0	<p>Among others:</p> <ul style="list-style-type: none"> <li>• General corrections</li> <li>• Corrections with adaptation for IP66 design</li> <li>• Adaptation of parameters: P245, 434, 553, 558</li> <li>• Error message E7.0 / E7.1 added</li> </ul>
<b>BU 0180</b> , July 2021	<b>6071802</b> / 3021	V 1.3 R0	<ul style="list-style-type: none"> <li>• Update "Standards and approvals"</li> <li>• Update of EU Declaration of Conformity</li> <li>• Addition of the energy efficiency levels according to the EU Ecodesign Regulation 1781</li> </ul>

Table 1: Version list

## Copyright notice

As an integral component of the device described here, this document must be provided to all users in a suitable form.

Any editing or amendment or other utilisation of the document is prohibited.

## Publisher

**Getriebbau NORD GmbH & Co. KG**

Getriebbau-Nord-Straße 1 • 22941 Bargteheide, Germany • <http://www.nord.com/>  
Fon +49 (0) 45 32 / 289-0 • Fax +49 (0) 45 32 / 289-2253

**Member of the NORD DRIVESYSTEMS Group**



## Table of Contents

<b>1</b>	<b>General</b> .....	<b>11</b>
1.1	Overview .....	11
1.2	Delivery .....	14
1.3	Scope of delivery .....	14
1.4	Safety, installation and application information .....	18
1.5	Warning and hazard information .....	22
1.5.1	Warning and hazard information on the product .....	22
1.5.2	Warning and hazard information in the document .....	23
1.6	Standards and approvals .....	23
1.6.1	UL and CSA approval .....	25
1.7	Type code / nomenclature .....	27
1.7.1	Name plate .....	27
1.7.2	Frequency inverter type code .....	28
1.7.3	Type code for option modules .....	28
1.7.4	Type code, connection unit for technology unit.....	29
1.7.5	Adapter Unit type code .....	29
1.8	Power rating / Motor size .....	29
1.9	Version in protection class IP55, IP66, IP69K.....	30
<b>2</b>	<b>Assembly and installation</b> .....	<b>32</b>
2.1	Installation SK 1x0E .....	32
2.1.1	Work procedures for motor installation .....	33
2.1.1.1	Adapters for different motors .....	33
2.1.1.2	Dimensions, SK 1x0E mounted on motor .....	34
2.1.2	Wall mounting.....	36
2.2	Installation of optional modules .....	38
2.2.1	Option locations on device .....	38
2.2.2	Installation of internal customer unit SK CU4-... (installation) .....	40
2.2.3	Installation of external technology units SK TU4-... (attachment).....	41
2.3	Braking resistor (BW) - (from size 2) .....	42
2.3.1	Internal braking resistor SK BRI4-.....	42
2.3.2	External braking resistor SK BRE4-... / SK BRW4-... / SK BREW4-.....	43
2.4	Electrical Connection .....	45
2.4.1	Wiring guidelines .....	46
2.4.2	Electrical connection of power unit .....	47
2.4.2.1	Mains supply (L1, L2(N), L3, PE) .....	47
2.4.2.2	Motor cable .....	49
2.4.2.3	Braking resistor (+B, -B) – (from size 2) .....	49
2.4.3	Electrical connection of the control unit .....	50
2.4.3.1	Control terminal details .....	51
2.5	Operation in potentially explosive environments .....	54
2.5.1	Operation in potentially explosive environments - ATEX zone 22 3D .....	54
2.5.1.1	Modification of the device for compliance with category 3D .....	54
2.5.1.2	Options for ATEX Zone 22, category 3D .....	55
2.5.1.3	Maximum output voltage and torque reduction .....	57
2.5.1.4	Commissioning information .....	57
2.5.1.5	EU conformity declaration - ATEX .....	59
2.5.2	Operation in potentially explosive environments - EAC Ex.....	60
2.5.2.1	Modification of the device .....	60
2.5.2.2	Further Information .....	61
2.5.2.3	EAC Ex certificate .....	61
2.6	Outdoor installation .....	62
<b>3</b>	<b>Display, operation and options</b> .....	<b>63</b>
3.1	Control and parametrisation options .....	63
3.1.1	Control and parameterisation units, use .....	64
3.1.2	Connection of multiple devices to one parametrisation tool.....	65
3.2	Optional modules .....	66
3.2.1	Internal customer interfaces SK CU4-... (installation of modules) .....	66
3.2.2	External technology units SK TU4-... (module attachment) .....	67

3.2.3	plug connectors .....	69
3.2.3.1	Plug connectors for power connections .....	69
3.2.3.2	Plug connectors for control connection .....	70
3.2.4	Potentiometer adapter, SK CU4-POT .....	72
<b>4</b>	<b>Commissioning .....</b>	<b>73</b>
4.1	Factory settings .....	73
4.2	Selecting the operating mode for motor control .....	74
4.2.1	Explanation of the operating modes (P300) .....	74
4.2.2	Overview of control parameter settings .....	74
4.2.3	Motor control commissioning steps .....	75
4.3	Starting up the device .....	77
4.3.1	Connection .....	77
4.3.2	Configuration .....	77
4.3.2.1	Parameterisation .....	77
4.3.2.2	DIP switches (S1, S2) .....	78
4.3.3	Commissioning examples .....	79
4.4	Temperature sensors .....	80
4.5	AS Interface (AS-i) .....	83
4.5.1	The bus system .....	83
4.5.2	Features and technical data .....	83
4.5.3	Bus structure and topology .....	84
4.5.4	Commissioning .....	85
4.5.4.1	Connection .....	85
4.5.4.2	Displays .....	86
4.5.4.3	Configuration .....	86
4.5.4.4	Addressing .....	87
4.5.5	Certificate .....	88
<b>5</b>	<b>Parameter .....</b>	<b>89</b>
5.1	Parameter overview .....	92
5.2	Description of parameters .....	95
5.2.1	Operating displays .....	96
5.2.2	Basic parameters .....	97
5.2.3	Motor data / Characteristic curve parameters .....	104
5.2.4	Speed control .....	112
5.2.5	Control terminals .....	117
5.2.6	Additional parameters .....	136
5.2.7	Information .....	152
<b>6</b>	<b>Operating status messages .....</b>	<b>163</b>
6.1	Display of messages .....	163
6.2	Diagnostic LEDs on device .....	164
6.3	Messages .....	165
6.4	FAQ operational problems .....	172
<b>7</b>	<b>Technical data .....</b>	<b>174</b>
7.1	General data for frequency inverter .....	174
7.2	Technical data for determining the energy efficiency level .....	175
7.3	Electrical data .....	176
7.3.1	Electrical data 1~ 115 V .....	177
7.3.2	Electrical data 1/3~230 V .....	178
7.3.3	Electrical data 3~ 400 V .....	180
<b>8</b>	<b>Additional information .....</b>	<b>182</b>
8.1	Setpoint processing .....	182
8.2	Process controller .....	183
8.2.1	Process controller application example .....	183
8.2.2	Process controller parameter settings .....	184
8.3	Electromagnetic compatibility (EMC) .....	185
8.3.1	General Provisions .....	185
8.3.2	EMC evaluation .....	186
8.3.3	EMC of device .....	187
8.3.4	EU Declaration of Conformity .....	189
8.4	Reduced output power .....	190
8.4.1	Increased heat dissipation due to pulse frequency .....	190

8.4.2	Reduced overcurrent due to time .....	191
8.4.3	Reduced overcurrent due to output frequency .....	192
8.4.4	Reduced output current due to low voltage .....	193
8.4.5	Reduced output current due to the heat sink temperature.....	193
8.5	Operation with FI circuit breakers .....	194
8.6	System bus .....	195
8.7	Energy Efficiency .....	198
8.8	Motor data - characteristic curves .....	199
8.8.1	50 Hz characteristic curve .....	199
8.8.2	87 Hz characteristic curve (only 400V devices) .....	201
8.8.3	100 Hz characteristic curve (only 400 V devices).....	202
8.9	Standardisation of setpoint / target values .....	204
8.10	Definition of setpoint and actual value processing (frequencies) .....	205
<b>9</b>	<b>Maintenance and servicing information.....</b>	<b>206</b>
9.1	Maintenance Instructions .....	206
9.2	Service notes .....	207
9.3	Abbreviations .....	208



## List of illustrations

Figure 1: Device with internal SK CU4-.....	12
Figure 2: Device with external SK CU4-.....	12
Figure 3: Name plate .....	27
Figure 4: Example of motor size adaptation .....	34
Figure 5: Option locations, size 1 .....	38
Figure 6: Option locations, size 2 .....	38
Figure 7: Jumpers for mains adaptation .....	48
Figure 8: SimpleBox, handheld, SK CSX-3H.....	64
Figure 9: ParameterBox, handheld, SK PAR-3H.....	64
Figure 10: internal customer units SK CU4 ... example .....	66
Figure 11: external technology units SK TU4-... (example).....	67
Figure 12: Examples of devices with connectors for connecting the power.....	69
Figure 13: Wiring diagram SK CU4-POT, example SK 1x0E .....	72
Figure 14: Connecting terminals AS-i .....	85
Figure 15 Setpoint processing .....	182
Figure 16: Process controller flow diagram .....	183
Figure 17: Wiring recommendation.....	188
Figure 18: Heat losses due to pulse frequency.....	190
Figure 19: Reduced output current due to low voltage .....	193
Figure 20: Energy efficiency due to automatic flux optimisation .....	198
Figure 21: 50 Hz characteristic curve .....	199
Figure 22: 87 Hz characteristic curve .....	201
Figure 23: 100 Hz characteristic curve .....	202

## List of tables

Table 1: Version list .....	3
Table 2: Warning and hazard information on the product .....	22
Table 3: Standards and approvals .....	23
Table 4: Standards and approvals for explosion hazard environments .....	24
Table 5: Assignment of braking resistors to frequency inverter .....	44
Table 6: Connection data .....	47
Table 7: external bus modules and IO expansions SK TU4- ... ..	68
Table 8: external modules with power supply SK TU4-24V- ... / SK TU4-POT- ... ..	68
Table 9: external modules – maintenance switch SK TU4-MSW- .....	68
Table 10: Temperature sensors, adjustment .....	80
Table 11: AS Interface, connection of signal and supply lines .....	86
Table 12: FAQ operational problems .....	173
Table 13: EMC comparison between EN 61800-3 and EN 55011 .....	186
Table 14: Overview according to product standard EN 61800-3 .....	188
Table 15: Overcurrent relative to time .....	191
Table 16: Overcurrent relative to pulse and output frequency .....	192
Table 17: Processing of setpoints and actual values in the frequency inverter .....	205

## 1 General

The SK 1x0E series is based on the tried and tested NORD platform. The frequency inverters are characterised by their compact design and optimum control characteristics, and have uniform parametrisation.

The frequency inverters have sensorless current vector control with a wide range of settings. In combination with suitable motor models, which always provide an optimised voltage/frequency ratio, all three-phase asynchronous motors that are suitable for inverter operation and permanently excited synchronous motors can be driven. For the drive unit, this means very high starting and overload torques with constant speed.

The power range is from 0.25 kW to 2.2 kW.

This series of frequency inverters can be adapted to individual requirements by means of modular assemblies.

This manual is based on the device software as stated in the version list (see P707). If the frequency inverter uses a different software version, this may cause differences. If necessary, the current manual can be downloaded from the Internet (<http://www.nord.com/>).

Additional descriptions exist for optional functions and bus systems (<http://www.nord.com/>).



### Information

#### Accessories

The accessories that are mentioned in the manual are also subject to changes. Current details of these are included in separate data sheets, which are listed under [www.nord.com](http://www.nord.com) under the heading *Documentation* → *Manuals* → *Electronic drive technology* → *Techn. Info / Data sheet*. The data sheets available at the date of publication of this manual are listed by name in the relevant sections (TI ...).

---

Installation directly on a motor is typical of this device series. Alternatively, optional accessories are also available for mounting the devices close to the motor, e.g. on the wall or on a machine frame.

In order to have access to all parameters, the internal RS232 interface (access via RJ12 connection) can be used. Access to the parameters takes place via an optional SimpleBox or ParameterBox, for example.

The parameter settings modified by the operator are backed up in the integrated, non-volatile memory of the device.

### 1.1 Overview

This manual describes all of the possible functions and equipment. The equipment and functionality are limited according to the type of device.

#### Basic characteristics

- High starting torque and precise motor speed control setting by means of sensorless current vector control
- Can be installed directly on, or close to the motor.
- Permissible ambient temperature -25°C to 50°C (please refer to technical data)
- Integrated EMC mains filter for limit curve B, Category C1, motor-mounted (not with 115 V devices)
- Automatic measurement of stator resistance and determination of the exact motor data possible
- Programmable direct current braking

- Size 2 only: Built-in brake chopper for 4 quadrant operation, optional braking resistors (internal / external)
- 2 analogue inputs (switchable between current and voltage operation), which can also be used as digital inputs.
- 3 digital inputs
- 2 digital outputs
- Separate temperature sensor input (TF+/TF-)
- NORD system bus for connecting additional modules, with switchable terminating resistance and address which can be set using DIP switches.
- Four separate parameter sets, switchable online
- LEDs for diagnosis
- RS232/485 interface via RJ12 plug
- Operation of *three-phase current Asynchronous Motors* (ASM) and *Permanent Magnet Synchronous Motors* (PMSM)
- Integrated PLC (📖 [BU 0550](#))

#### Additional features of the SK 190E

- Integrated AS Interface

#### Option modules

Option modules are used to extend the functionality of the device.

These options are available as an installation variant, the so-called SK CU4-... customer unit, and also as an attachment variant, the so-called SK TU4-... technology unit. As well as the mechanical differences, the installation and attachment variants also have some functional differences.

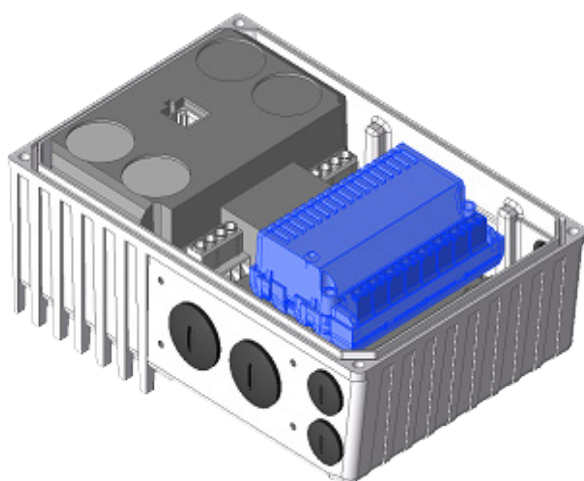

Figure 1: Device with internal SK CU4-...

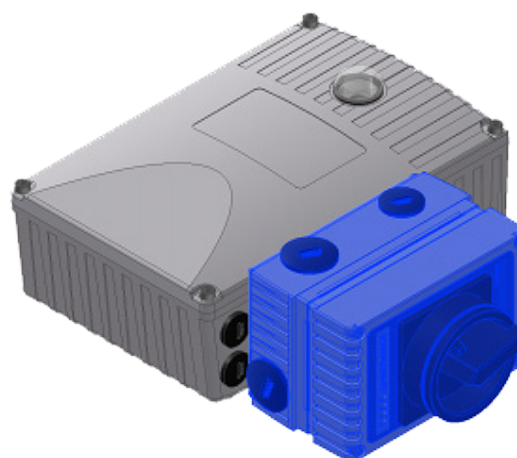

Figure 2: Device with external SK CU4-...

#### Attachment variant

The **external technology unit (Technology Unit SK TU4-...)** is externally attached to the device and is therefore easy to access.

A technology unit basically requires the use of a suitable SK TI4-TU-... connection unit.

The power supply and signal lines are connected using the screw clamps of the connection unit. Depending on the version, additional connections for connectors (e.g. M12 or RJ45) may be available.

The optional wall mounting kit SK TIE4-WMK-TU also allows the technology units to be mounted away from the starter.

*Built-in variant*

The **internal customer unit (Customer Unit, SK CU4-...)** is integrated in the device. The power supply and signal lines are connected using screw clamps.

The **SK CU4-POT** potentiometer adapter is an exception among the "SK CU4 Modules", since it is not integrated in the device but attached to it.

Communication between "intelligent" option modules and the device takes place via the system bus. Intelligent option modules are modules with their own processor and communication technology, as is the case with field bus modules, for example.

The frequency inverter can manage the following options via its system bus:

- 1 x ParameterBox SK PAR-3H and (via an RJ12 connector)
- 1 x field bus option (e.g. Profibus DP), internal or external and
- 2 x I/O extension (SK xU4-IOE-...), internal and / or external

Up to 4 frequency inverters with their appropriate options can be connected to a system bus.

## 1.2 Delivery

Examine the frequency inverter for transport damage or loose components **immediately** on delivery / unpacking.

In case of damage, contact the carrier immediately and arrange for a careful survey.

**Important! This also applies if the packaging is undamaged.**

## 1.3 Scope of delivery

### NOTICE



#### Defect in the device







Use of unapproved accessories and options (e.g. options from other device series (SK CSX 0)) may result in defects of the interconnected components.











- Only use accessories and options which are explicitly intended for use with this device and stated in this manual.

- Standard version:*
- IP55 version of device (optionally IP66, IP69K)
  - Operating instructions as PDF file on CD ROM including NORD CON, (PC parametrisation software)







*Available accessories:*

	Designation	Example	Description
Control and parametrisation options	Parametrisation units for temporary connection to the device, handheld		For commissioning, parametrisation and control of the device. <b>Model SK PAR-3H, SK CSX-3H</b> 📖 Section 3.1 "Control and parametrisation options "
	Hand-held control units		For controlling the device, <b>Model SK POT- ...</b> 📖 Section 3.1 "Control and parametrisation options "
	NORD CON MS Windows® - based software		For commissioning, parametrisation and control of the device. Refer to <a href="http://www.nord.com">www.nord.com</a> <b>NORD CON</b> (Free download)

Bus interface	Internal bus interfaces		Customer unit for installation device for: CANopen, DeviceNet, EtherCAT, Ethernet/IP, Powerlink, Profibus DP, Profinet IO <b>Model SK CU4- ...</b> 📖 Section 3.2.1 "Internal customer interfaces SK CU4-... (installation of modules)"
	External bus interfaces		Technology unit for attaching to the device or alternatively for wall mounting (wall mounting kit required) for: CANopen, DeviceNet, EtherCAT, Ethernet/IP, Powerlink, Profibus DP, Profinet IO, <b>Model SK TU4- ...</b> 📖 Section 3.2.2 "External technology units SK TU4-... (module attachment)"
Braking resistors	Internal braking resistors		Braking resistor for installation in the device for leading away generated heat from the drive system caused by conversion to heat. Energy is generated by the braking processes or downward movement of loads, <b>Model SK BRI4- ...</b> 📖 Section 2.3.1 "Internal braking resistor SK BRI4-..."
	External braking resistors		Refer to: <i>Internal braking resistors,</i> but for attaching to the device <b>Model SK BRE4- ...</b>  📖 Section 2.3.2 "External braking resistor SK BRE4-... / SK BRW4-... / SK BREW4-..."
I/O expansions	Internal I/O expansion		Customer unit for installing in the device for extending the analogue and digital inputs and outputs. <b>Model SK CU4-IOE...</b> 📖 Section 3.2.1 "Internal customer interfaces SK CU4-... (installation of modules)"
	Internal signal converter		Customer unit for installation in the device for converting bipolar analogue signals to unipolar analogue signals, e.g. digital signals on relays <b>Model SK CU4-REL- ...</b> 📖 Section 3.2.1 "Internal customer interfaces SK CU4-... (installation of modules)"
	External I/O extension		Technology unit for attaching to the device or alternatively for wall mounting (wall mounting kit required) for extending the analogue and digital inputs and outputs. <b>Model SK TU4-IOE- ...</b> 📖 Section 3.2.2 "External technology units SK TU4-... (module attachment)"

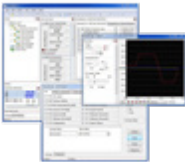
Wall mounting	<b>Wall-mounting kit for the device</b> 	Set for mounting the device, separated from the motor (e.g. on a wall) <b>Type SK TIE4-WMK-...</b> (📖 Section 2.1.2 "Wall mounting")
	<b>Wall-mounting kit for SK TU4-... modules</b> 	Set for mounting the technology unit, SK TU4-..., separated from the device (e.g. on a wall), <b>SK TIE4-WMK-TU</b> (📖 Section 3.2.2 "External technology units SK TU4-... (module attachment)")
Switches and potentiometers	<b>Switch / potentiometer unit</b> (L – OFF – R / 0 – 10 V) 	Customer unit for attaching to the device for ease of control of the device using switches and potentiometers <b>Model SK CU4-POT</b> (📖 Section 3.1 "Control and parametrisation options ")
	<b>ATEX potentiometer</b> (0 – 10 V) 	Potentiometer with ATEX capability for attaching to the device for ease of control of the device <b>Model SK ATX-POT</b> (📖 Section 0 "SK ATX-POT")
	<b>Potentiometer</b> (0 – 10 V) 	Potentiometer for attaching to the device for ease of control of the device <b>Model SK TIE4-POT</b> (📖 Section 3.1 "Control and parametrisation options ")
	<b>Switch</b> (L – OFF – R) 	Switch for attaching to the device for simple control of the device <b>Model SK TIE4-SWT</b> (📖 Section 3.1 "Control and parametrisation options ")
	<b>Maintenance switch</b> (0 – I) 	Technology unit for attaching to the device or alternatively for wall mounting (wall mounting kit required) for safely insulating the device from the AC power supply. <b>Model SK TU4-MSW- ...</b> (📖 Section 3.2.2 "External technology units SK TU4-... (module attachment)")
	<b>Setpoint adjuster</b> (L – 0 – R / 0 – 100 %) 	Technology unit for attaching to the device or alternatively for wall mounting (wall mounting kit required) for simple control of the device using buttons and potentiometers, including power supply for generating a 24 V DC control voltage. <b>Model SK TU4-POT- ...</b> (📖 Section 3.2.2 "External technology units SK TU4-... (module attachment)")
Plug connector	<b>Power connection</b> (for power input, power output, motor output) 	AC Power connector for attaching to the device for making a detachable connection for supply lines (e.g. mains supply line) <b>Model SK TIE4-...</b> (📖 Section 3.2.3 "plug connectors")
	<b>Control line connection</b> 	System connector (M12) for attaching to the device, for making a detachable connection for control lines <b>Model SK TIE4-...</b> (📖 Section 3.2.3 "plug connectors")



Adapter	Adapter cable		Different adapter cables ( <a href="#">Link</a> )
	Mounting Adapter		Various adapter kits for attaching the device to different motor sizes 📖 Section 2.1.1.1 "Adapters for different motors"
Miscellaneous	Internal electronic brake rectifier		Customer unit for installing in the device for direct actuation of an electro-mechanical brake <b>Model SK CU4-MBR- ...</b> 📖 Section 3.2.1 "Internal customer interfaces SK CU4-... (installation of modules)"
Software (Free download)	NORDCON MS Windows ®-based software		For commissioning, parametrisation and control of the device. See <a href="http://www.nord.com">www.nord.com</a> <a href="#">NORDCON</a>
	ePlan macros		Macros for producing electrical circuit diagrams See <a href="http://www.nord.com">www.nord.com</a> <a href="#">ePlan</a>
	Device master data		Device master data/device description files for NORD field bus options <a href="#">NORD field bus files</a>
	S7 standard modules for PROFIBUS DP and PROFINET IO		Standard modules for NORD frequency inverters See <a href="http://www.nord.com">www.nord.com</a> <a href="#">S7 Files NORD</a>
	Standard modules for the TIA portal for PROFIBUS DP and PROFINET IO		Standard modules for NORD frequency inverters <i>Available on request.</i>

## 1.4 Safety, installation and application information

Before working on or with the device, please read the following safety instructions extremely carefully. Please pay attention to all other information from the device manual.

Non-compliance can result in serious or fatal injuries and damage to the device or its surroundings.

**These safety instructions must be kept in a safe place!**

### 1. General

Do not use defective devices or devices with defective or damaged housings or missing covers (e.g. blind plugs for cable glands). Otherwise there is a risk of serious or fatal injuries caused by electric shock or bursting electrical components such as powerful electrolytic capacitors.

Unauthorised removal of covers, improper use, incorrect installation or operation causes a risk of serious personal injury or material damage.

During operation and depending on the protection class of the devices, there may be live, bare, moving or rotating parts or hot surfaces.

The device operates with a dangerous voltage. Dangerous voltage may be present at the supply lines, contact strips and PCBs of all connecting terminals (e.g. mains input, motor connection), even if the device is not working or the motor is not rotating (e.g. caused by electronic disabling, jamming of the drive or a short circuit at the output terminals).

The device is not equipped with a mains switch and is therefore always live when connected to the power supply. Voltages may therefore be connected to a connected motor at standstill.

Even if the drive unit has been disconnected from the mains, a connected motor may rotate and possibly generate a dangerous voltage.

If you come into contact with dangerous voltage such as this, there is a risk of an electric shock, which can lead to serious or fatal injuries.

The device and any power plug connectors must not be disconnected while a voltage is applied to the device. Failure to comply with this may cause arcing, which in addition to the risk of injury, also results in a risk of damage or destruction of the device.

The fact that the status LED or other indicators are not illuminated does not indicate that the device has been disconnected from the mains and is without voltage.

The heat sink and all other metal components can heat up to temperatures above 70 °C.

Touching these parts can result in local burns to the body parts concerned (cooling times and clearance from neighbouring components must be complied with).

All work on the device, e.g. transportation, installation, commissioning and maintenance work must be carried out by qualified experts (observe IEC 364 or CENELEC HD 384 or DIN VDE 0100 and IEC 664 or DIN VDE 0110 and national accident prevention regulations). In particular, the general and regional installation and safety regulations for work on high voltage systems (e.g. VDE) must be complied with as must the regulations concerning correct use of tools and the use of personal protection equipment.

During all work on the device, take care that no foreign bodies, loose parts, moisture or dust enter or remain in the device (risk of short circuit, fire and corrosion).

Further information can be found in this documentation.

### 2. Qualified experts

For the purposes of these basic safety instructions, qualified personnel are persons who are familiar with the assembly, installation, commissioning and operation of this product and who have the relevant qualifications for their work.

Furthermore, the device and the associated accessories may only be installed and started up by qualified electricians. An electrician is a person who, because of their technical training and experience, has sufficient knowledge with regard to

- switching on, switching off, isolating, earthing and marking power circuits and devices,
- proper maintenance and use of protective devices in accordance with defined safety standards.

### **3. Correct purpose of use – general**

The frequency inverters are devices for industrial and commercial systems used for the operation of three-phase asynchronous motors with squirrel-cage rotors and Permanent Magnet Synchronous Motors – PMSM. These motors must be suitable for operation with frequency inverters, other loads must not be connected to the devices.

The devices are components intended for installation in electrical systems or machines.

Technical data and information for connection conditions can be found on the rating plate and in the documentation, and must be complied with.

The devices may only be used for safety functions which are described and explicitly approved.

CE-labelled devices fulfil the requirements of the Low Voltage Directive 2014/35/EU. The stated harmonized standards for the devices are used in the declaration of conformity.

#### **a. Supplement: Correct purpose of use within the European Union**

When installed in machines, the devices must not be commissioned (i.e. commencement of proper use) until it has been ensured that the machine fulfils the provisions of EC Directive 2006/42/EC (Machinery Directive); EN 60204-1 must also be complied with.

Commissioning (i.e. start-up of proper use) is only permitted if the EMC directive (2014/30/EU) has been complied with.

#### **b. Supplement: Correct purpose of use outside the European Union**

The local conditions of the operator for the installation and commissioning of the device must be complied with at the usage location (see also "a) Supplement: Correct purpose of use within the European Union").

### **4. Phases of life**

#### ***Transport, storage***

The information in the manual regarding transport, storage and correct handling must be complied with.

The permissible mechanical and climatic ambient conditions (see technical data in the manual for the device) must be complied with.

If necessary, suitable, adequately dimensioned means of transport (e.g. lifting gear, rope guides) must be used.

#### ***Installation and assembly***

The installation and cooling of the device must be implemented according to the regulations in the corresponding documentation. The permissible mechanical and climatic ambient conditions (see technical data in the manual for the device) must be complied with.

The device must be protected against impermissible loads. In particular, components must not be deformed and/or insulation distances must not be changed. Touching of electronic components and contacts must be avoided.

The device and its optional modules contain electrostatically sensitive components, which can be easily damaged by incorrect handling. Electrical components must not be mechanically damaged or destroyed.

#### ***Electrical connection***

Ensure that the device and the motor are specified for the correct supply voltage.

Installation, maintenance and repair work must not be carried out unless the device has been disconnected from the voltage and at least 5 minutes have elapsed since the mains was switched off! (Due to charged capacitors, the equipment may continue to carry hazardous voltages for up to 5 minutes after being switched off at the mains). Before starting work it is essential to check by measurement that all contacts of the power plug connections or the connection are voltage-free.

The electrical installation must be implemented according to the applicable regulations (e.g. cable cross-section, fuses, earth lead connections). Further instructions can be found in the documentation or manual for the device.

Information regarding EMC-compliant installation such as shielding, earthing, location of filters and routing of cables can be found in the documentation for the devices and in the technical information manual [TI 80-0011](#). This information must always be observed even with inverters with a CE label. Compliance with the limit values specified in the EMC regulations is the responsibility of the manufacturer of the system or machine.

In case of a fault, inadequate earthing may result in electric shock, possibly with fatal consequences.

The device may only be operated with effective earth connections which comply with local regulations for large leakage currents (> 3.5 mA). Detailed information regarding connections and operating conditions can be obtained from the technical Information manual [TI 80-0019](#).

Connection of the supply voltage may directly or indirectly set the inverter into operation. Contact with electrically live components will result in electric shock, possibly with fatal consequences.

All poles of cable connections (e.g. power supply) must always be disconnected.

### ***Set-up, troubleshooting and commissioning***

When working on live devices, the applicable national accident prevention regulations must be complied with (e.g. BGV A3, formerly VBG 4).

The voltage supply of the device may directly or indirectly put it into operation, or touching electrically conducting components may then cause an electric shock with possible fatal consequences.

The parametrisation and configuration of the devices must be selected so that no hazards can occur.

With certain setting conditions, the device or the motor which is connected to it may start automatically when the mains are switched on. The machinery which it drives (press / chain hoist / roller / fan etc.) may then make an unexpected movement. This may cause various injuries, including to third parties.

Before switching on the mains, secure the danger area by warning and removing all persons from the danger area.

### ***Operation***

Where necessary, systems in which the devices are installed must be equipped with additional monitoring and protective equipment according to the applicable safety requirements (e.g. legislation concerning technical equipment, accident prevention regulations, etc.).

All covers must be kept closed during operation.

With certain setting conditions, the device or the motor which is connected to it may start automatically when the mains are switched on. The machinery which it drives (press / chain hoist / roller / fan etc.) may then make an unexpected movement. This may cause various injuries, including to third parties.

Before switching on the mains, secure the danger area by warning and removing all persons from the danger area.

Due to its operation, the device produces noises within the audible frequency range. These noises may cause long-term stress, discomfort and fatigue, with negative effects on concentration. The frequency range or the noise can be shifted to a less disturbing or almost inaudible range by adjustment of the pulse frequency. However, this may possibly result in derating (lower power) of the device.

### ***Maintenance, repair and decommissioning***

Installation, maintenance and repair work must not be carried out unless the device has been disconnected from the voltage and at least 5 minutes have elapsed since the mains was switched off! (Due to charged capacitors, the equipment may continue to carry hazardous voltages for up to 5 minutes after being switched off at the mains). Before starting work it is essential to check by measurement that all contacts of the power plug connections or the connection are voltage-free.

For further information, please refer to the manual for the device.

### ***Disposal***

The product and its parts and accessories must not be disposed of as domestic waste. At the end of its life, the product must be properly disposed of according to the local regulations for industrial waste. In particular, this product contains integrated semiconductor circuits (PCBs and various electronic components, including high power capacitors). In case of incorrect disposal there is a risk of formation of toxic gases, which may cause contamination of the environment and direct or indirect injuries (e.g. chemical burns). In the case of high power capacitors, there is also a risk of explosion, with the associated risk of injury.

## **5. Potentially explosive environment (ATEX, EAC Ex)**

In order to operate or carry out installation work in potentially explosive environments (ATEX, EAC Ex), the device must be approved and the relevant requirements and notes from the manual of the device must be complied with.

Failure to comply can result in the ignition of an explosive atmosphere and fatal injuries.





- Only persons who are qualified, i.e. trained and authorised for all assembly, service, commissioning and operation work on association with explosion hazard environments may work with the devices described here (including the motors, geared motors, any accessories and all connection technology).
- Explosive concentrations of dust may cause explosions if ignited by hot or sparking objects. Such explosions may cause serious or fatal injuries to persons or severe material damage.
- The drive must comply with the specifications of "***Planning guideline for the operating and installation instructions B1091***" [B1091-1](#).
- Only original parts which are approved for the device and for operation in an explosion hazard area ATEX Zone 22 3D, EAC Ex must be used.
- **Repairs may only be carried out by Getriebebau NORD GmbH & Co. KG.**

## 1.5 Warning and hazard information

Under certain circumstances, hazardous situations may occur in association with the frequency inverter. In order to give explicit warning of possibly hazardous situations, clear warning and hazard information can be found on the device and in the relevant documentation.

### 1.5.1 Warning and hazard information on the product

The following warning and hazard information is used on the product.

Symbol	Supplement to symbol <sup>1)</sup>	Meaning
	DANGER Device is live > 5min after removing mains voltage	<p><b>⚠ Danger</b> <b>Electric shock</b></p> <p>The device contains powerful capacitors. Because of this, there may be a hazardous voltage for more than 5 minutes after disconnection from the mains.</p> <p>Before starting work, check that the device is free of voltage at all power contacts by means of suitable measuring equipment.</p>
		It is essential to read the manual in order to prevent hazards!
		<p><b>⚠ CAUTION</b> <b>Hot surfaces</b></p> <p>The heat sink and all other metal components as well as the surfaces of plug connectors may heat up to temperatures in excess of 70°C.</p> <ul style="list-style-type: none"> <li>• Danger of injury due to local burns on contact.</li> <li>• Heat damage to adjacent objects</li> </ul> <p>Allow sufficient cooling time before starting work on the device. Check the surface temperatures with suitable measuring equipment. Maintain an adequate distance to adjacent components or provide protection against contact.</p>
		<p><b>NOTICE</b> <b>EDS</b></p> <p>The device contains electrostatically sensitive components, which can be easily damaged by incorrect handling.</p> <p>Avoid all contact (indirect contact by tools or similar, or direct contact) with PCBs and their components.</p>



1) Texts are written in English.

Table 2: Warning and hazard information on the product

### 1.5.2 Warning and hazard information in the document

The warning and hazard information in this document are located at the beginning of the section which describes the action which may result in the corresponding hazards.

The warning and hazard information is classified as follows according to the risk and the severity of the resulting injuries.

 <b>DANGER!</b>	Indicates an immediate danger, which may result in death or serious injury.
 <b>WARNING</b>	Indicates a possibly dangerous situation, which may result in death or serious injury.
 <b>CAUTION</b>	Indicates a possibly dangerous situation, which may result in slight or minor injuries.
<b>NOTICE</b>	Indicates a possibly harmful situation, which may cause damage to the product or the environment.

### 1.6 Standards and approvals

All devices of the entire SK 200E series comply with the standards and directives listed below.





Approval	Directive	Applied standards	Certificates	Label
CE (European Union)	Low Voltage 2014/35/EU	EN 61800-5-1 EN 60529 EN 61800-3 EN 63000 EN 61800-9-1 EN 61800-9-2	C310400, C310401	
	EMC 2014/30/EU			
	RoHS 2011/65/EU			
	Delegated directive (EU) 2015/863			
	Ecodesign 2009/125/EC Regulation (EU) Ecodesign 2019/1781			
UL (USA)		UL 61800-5-1	E171342	
CSA (Canada)		C22.2 No.274-13	E171342	
RCM (Australia)	F2018L00028	EN 61800-3	133520966	
EAC (Eurasia)	TR CU 004/2011, TR CU 020/2011	IEC 61800-5-1 IEC 61800-3	EAЭC N RU Д- DE.HB27.B.0273 0/20	

Table 3: Standards and approvals

Devices which are configured and approved for use in explosion hazard environments (  Section 2.5 "Operation in potentially explosive environments ") comply with the following directives and standards.



Approval	Directive	Applied standards	Certificates	Code
ATEX <i>(European Union)</i>	ATEX 2014/34/EU	EN 60079-0	C432410	
	EMC 2014/30/EU	EN 60079-31 EN 61800-5-1		
	RoHS 2011/65/EU	EN 60529 EN 61800-3		
	Ecodesign 2009/125/EC	EN 63000 EN 61800-9-1		
	Regulation (EU) Ecodesign 2019/1781	EN 61800-9-2		
EAC Ex <i>(Eurasia)</i>	TR CU 012/2011	IEC 60079-0 IEC 60079-31	TC RU C-DE.AA87.B.01109	

Table 4: Standards and approvals for explosion hazard environments



### 1.6.1 UL and CSA approval

#### File No. E171342

Categorisation of protective devices approved by the UL according to United States Standards for the inverters described in this manual is listed below with essentially the original wording. The categorisation of individually relevant fuses or circuit breakers can be found in this manual under the heading "Electrical Data". All devices include motor overload protection.

( section 7.2 "Electrical data")

### Information

#### Group fuse protection

The devices can be protected as a group via one common fuse (see below for details). Pay attention to compliance with the total currents and the use of correct cables and cable cross-sections. If the device is mounted close to the motor, this also applies to the motor cables.

#### UL / CSA conditions according to the report

### Information

"Integral solid state short circuit protection does not provide branch circuit protection. Branch circuit protection must be provided in accordance with the National Electric Code and any additional local codes."

"Use 60/75°C copper field wiring conductors."

„These products are intended for use in a pollution degree 2 environment“

"The device has to be mounted according to the manufacturer instructions."

"For NFPA79 applications only"

### Information

#### Internal Break Resistors (PTCs)

Alternate - internal brake resistors, optional for drives marked for USL only (not for Canada), Unlisted Component NMTR3, manufactured by Getriebebau:

	Usage	Cat. No.
1	750-323, 111-323	BRK-100R0-10-L
2	FS2	BRK-200R0-10-L

Size	valid	description
1 - 2	generally valid	<p>“Suitable For Use On A Circuit Capable Of Delivering Not More Than 100 000 rms Symmetrical Amperes, 480 Volts Maximum” and minimum one of the two following alternatives.</p> <p>When used together with or without Accessory SK TU4-MSW:            “Suitable For Use On A Circuit Capable Of Delivering Not More Than 10 000 rms Symmetrical Amperes, 480 Volts Maximum” and minimum one of the two following alternatives.</p> <p>1. “When Protected by class RK5 Fuses or faster or when protected by High-Interrupting Capacity, Current Limiting Class CC, G, J, L, R, T, etc. Fuses, rated _____ Amperes, and _____ Volts”, as listed in <sup>1)</sup>.</p> <p>2. “Suitable For Use On A Circuit Capable Of Delivering Not More Than 65 000 rms Symmetrical Amperes, _____ Volt maximum”,            “When Protected by Circuit Breaker (inverse time trip type) in accordance with UL 489, rated _____ Amperes, and _____Volts”, as listed in <sup>1)</sup>.</p>
	<b>Motor group installation (Group fusing):</b>	<p>“Suitable for motor group installation on a circuit capable of delivering not more than 100 000 rms symmetrical amperes, 480 V max” “When Protected by class RK5 Fuses or faster, rated 30_Amperes”</p> <p>“Suitable for motor group installation on a circuit capable of delivering not more than 100 000 rms symmetrical amperes, 480 V max” “When Protected by High-Interrupting Capacity, Current Limiting Class CC, G, J, L, R, T, etc. Fuses rated 30 Amperes”</p> <p>“Suitable for motor group installation on a circuit capable of delivering not more than 65 000 rms symmetrical amperes, 480 V max” “When Protected by Circuit Breaker (inverse time trip type) in accordance with UL 489, rated 30 Amperes and 480 Volts min”</p>
	<b>differing data CSA:</b>	None differing data → equal to UL

1) (EN 7.2)

### 1.7 Type code / nomenclature

Unique type codes have been defined for the individual modules and devices. These provide individual details of the device type and its electrical data, protection class, fixing version and special versions. A differentiation is made according to the following groups:

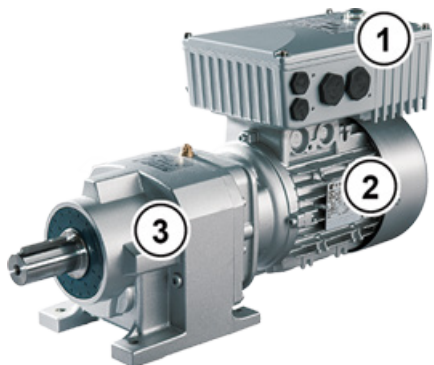

1	Frequency inverter
2	Motor
3	Gear units

5	Optional module
6	Connection unit
7	Wall-mounting kit

#### 1.7.1 Name plate

All of the information which is relevant for the device, including information for the identification of the device can be obtained from the type plate.

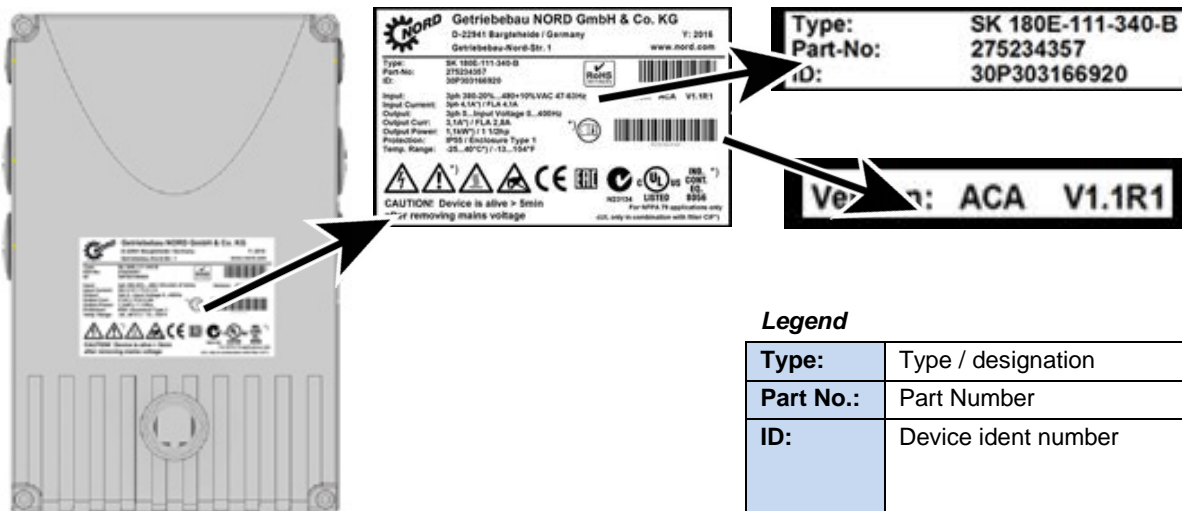

<b>Type:</b>	SK 180E-111-340-B
<b>Part-No.:</b>	275234357
<b>ID:</b>	30P303166920

<b>Ver.:</b>	ACA V1.1R1
--------------	------------

**Legend**

<b>Type:</b>	Type / designation
<b>Part No.:</b>	Part Number
<b>ID:</b>	Device ident number
<b>FW:</b>	Firmware version (x.x Rx)
<b>HW:</b>	Hardware version (xxx)

Figure 3: Name plate

## 1.7.2 Frequency inverter type code

SK 180E-370-323-B (-C) (-xxx)

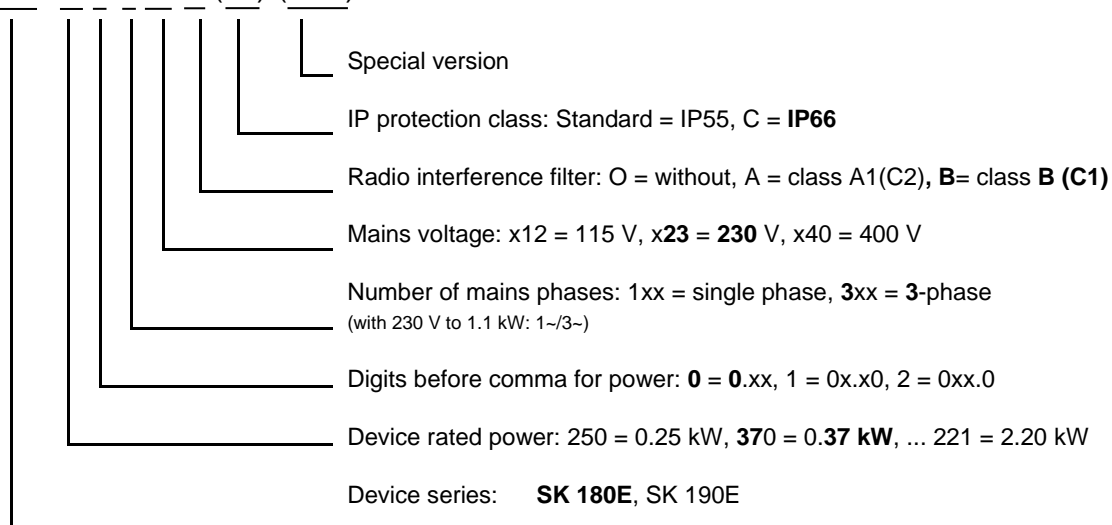

(...) Options, only implemented if required.

## 1.7.3 Type code for option modules

For bus module or I/O extension

SK TU4-CAO (-C-M12)

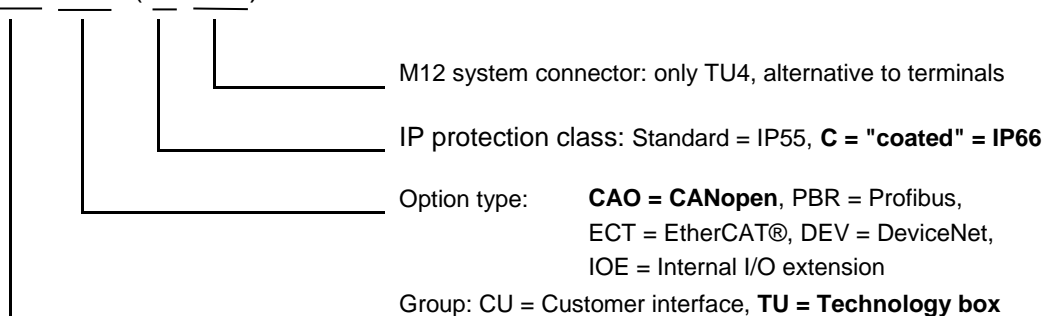

(...) Options, only implemented if required.

### 1.7.4 Type code, connection unit for technology unit

#### SK TI4-TU-BUS (-C)

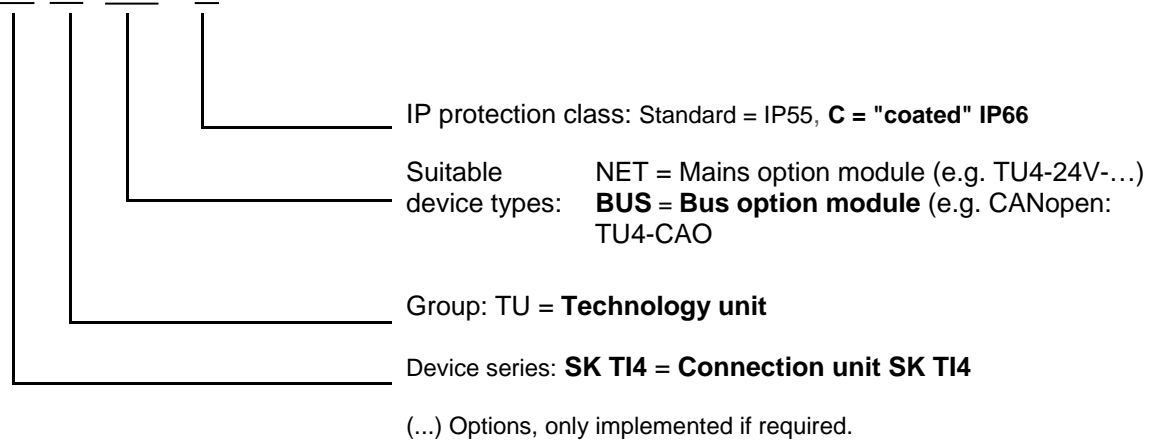

### 1.7.5 Adapter Unit type code

#### SK TIE4-WMK-1 (-C- ...)

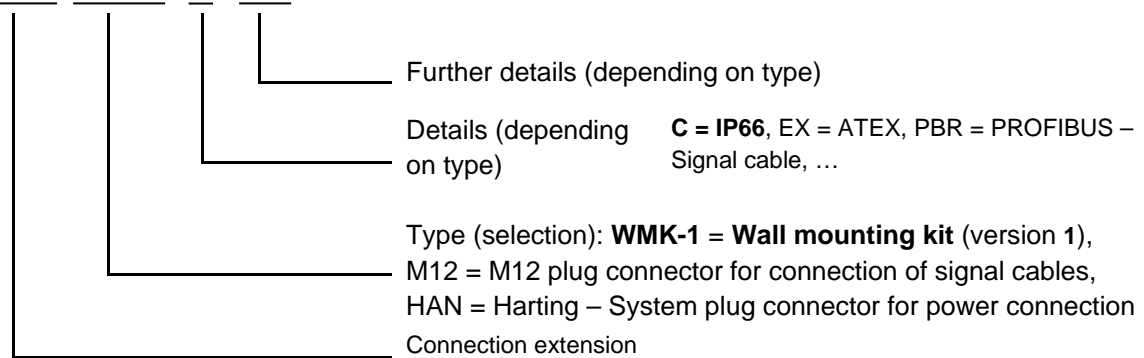

## 1.8 Power rating / Motor size

Size	Mains / output assignment			
	1~ 110 - 120 V	1~/ 3~ 200 – 240 V	3~ 200 – 240 V	3~ 380 – 480 V
Size 1	0.25 ... 0.75 kW	0.25 ... 0.55 kW	-	0.25 ... 1.1 kW
Size 2	-	0.75 ... 1.1 kW	1.5 kW	1.5 ... 2.2 kW

## 1.9 Version in protection class IP55, IP66, IP69K

The SK 1x0E is available in IP55 (standard) or IP66, IP69K (optional). The additional modules are available in protection classes IP55 (standard) or IP66 (optional).

A protection class that differs from the standard (IP66, IP69K) must always be specified in the order when ordering!

There are no restrictions or differences to the scope of functionality in the protection classes that have been mentioned. The type designation is extended accordingly in order to distinguish between the protection classes.

e.g. SK 1x0E-221-340-A-C



### Information

### Cable laying

For all versions, care must be taken that the cables and the cable glands at least comply with the protection class of the device and the attachment regulations and are carefully matched. The cables must be inserted so that water is deflected away from the device (if necessary use loops). This is essential to ensure that the required protection class is maintained.

---

#### IP55 version:

The IP55 version is the **standard** version. In this version, the two installation types *motor mounted* (fitted onto the motor) and *close coupled* (fitted to the wall bracket) are available. All adapter units, technology units and customer units are also available for this version.

#### IP66 version:

The IP66 version is a modified **option** of the IP55 version. Both installation types (*motor-integrated*, *close coupled*) are also available for this version. The modules available to the IP66 design (adapter units, technology units and customer units) have the same functionalities as the corresponding IP55 design modules.

---



### Information

### IP66 special measures

The modules for the IP66 version are identified by an additional "-C" in the type key, and are modified with the following special measures:

- impregnated PCBs,
  - Powder coating RAL 9006 (white aluminium) for housing,
  - modified blank screw caps (UV-resistant),
  - Diaphragm valve for pressure compensation in the event of temperature changes,
  - Low pressure test.
    - A free M12 screw connection is required for low pressure testing. After successful testing, a diaphragm valve is inserted here. This screw connection is therefore no longer available for a cable gland.
- 

If the frequency inverter is going to be retrofitted, i.e. the entire drive unit (inverter pre-attached to motor) is not being purchased from NORD, the diaphragm valve is supplied in the bag enclosed with the frequency inverter. The valve must be professionally installed on site by the system installer (**Note:** the valve must be installed in a location that is as high as possible in order to avoid contact with accumulated moisture (e.g. standing water due to condensation)).

---

 **Information**

---

**Diaphragm valve**

The diaphragm valve (accessories kit of the IP66 version of the frequency inverter's connection unit) ensures the compensation of pressure differences between the inside of the frequency inverter and its environment, and also prevents the ingress of moisture. When mounting into an M12 screw fitting of the inverter's connection unit, care must be taken that the diaphragm valve does not make contact with waterlogging.

## 2 Assembly and installation

### 2.1 Installation SK 1x0E

The devices are available in various sizes depending on their output. They can be mounted on the terminal box of a motor or in its immediate vicinity.

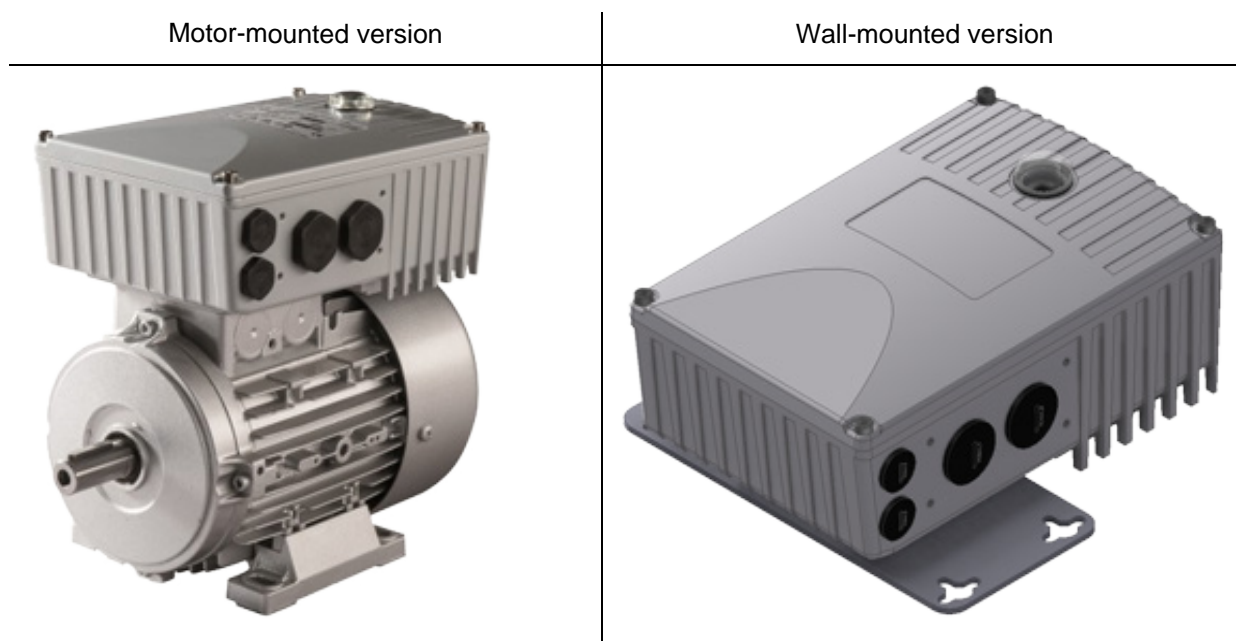

When a complete drive unit (gear unit + motor + SK 1x0E) is delivered, the device is always fully installed and tested.

#### **i** Information

#### Device version IP6x

IP6x-compliant devices must be installed by NORD, since special measures have to be implemented. IP6x components that are retrofitted on site cannot ensure that this protection class is provided.

When delivered separately, the device includes the following components:

- SK 1x0E
- Screws and contact washers for mounting the motor terminal box
- Pre-fabricated cable for motor and PTC connections

#### **i** Information

#### Power derating

The equipment requires **sufficient ventilation** to protect against overheating. If this cannot be guaranteed, this results in power reduction (derating) of the frequency inverter. The ventilation is influenced by the type of installation (motor-mounting, wall-mounting) and/or with motor-mounting: the air flow of the motor fan (continuous slow speed → lack of cooling).

Insufficient cooling can result in power reduction of 1 - 2 power stages during S1 operation, for example, which can only be compensated for by using a nominally bigger device.

Details concerning output reduction and possible ambient temperatures, and other details ( Section 7 "Technical data").



### 2.1.1 Work procedures for motor installation

1. If necessary, remove the original terminal box from the NORD motor, so that only the base of the terminal box and the motor terminal strip remain.
2. Set the bridges for the correct motor circuit at the motor terminal strip, and connect the pre-fabricated cables for motor and PTC connections to the respective connection points on the motor.
3. Remove the casing cover from the SK 1x0E. To do this, undo 4 fastening screws and then remove the casing cover vertically from above.



4. Fit the casing of the SK 1x0E to the terminal box base of the NORD motor using the existing screws and seal as well as the provided toothed contact washers. When doing this, align the casing so that the rounded side is facing the direction of the A bearing cover of the motor. Carry out mechanical adaptation using the "Adapter kit" (📖 Section 2.1.1.1 "Adapters for different motors"). With motors made by other manufacturers, it must be checked whether they can be attached.

If necessary, the plastic cover (1) for the electronics must be carefully removed in order to make the screw fastenings to the base of the terminal box. Proceed with extreme caution when doing this to avoid damage to the exposed PCBs.

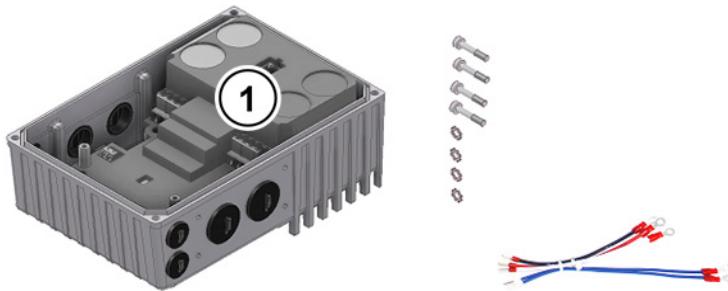

5. Make electrical connections. For the cable gland of the connecting cable, appropriate screwed connections for cable cross-section must be used.
6. Re-attach the casing cover. In order to ensure that the protection class for the device is achieved, care must be taken that all the fastening screws of the housing cover are tightened crosswise, gradually and with the torque specified in the table below.

The cable glands that are used must at least correspond to the protection class of the device.

Size SK 1x0E	Screw size	Tightening torque
Size 1	M5 x 25	3.5 Nm ± 20 %
Size 2	M5 x 25	3.5 Nm ± 20 %

#### 2.1.1.1 Adapters for different motors

In some cases, the terminal box attachments are different for different motor sizes. Therefore, it may be necessary to use adapters to mount the device.

In order to ensure that the maximum IPxx protection class of the device is provided for the entire unit, all elements of the drive unit (e.g. motor) must correspond to at least the same protection class.

**i Information**

**External motors**

The adaptability of motors from other manufacturers must be checked individually!

Information about converting a drive to the device can be found in [BU0320](#).

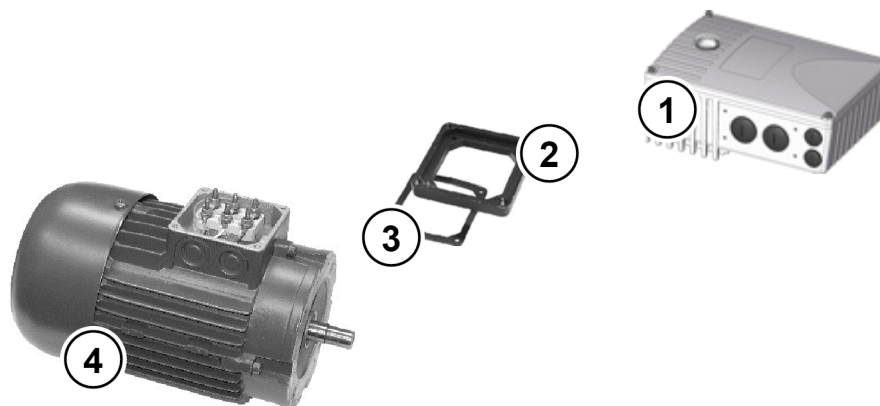

- 1 SK 1x0E
- 2 Adapter plate
- 3 Gasket
- 4 Motor, size 71

Figure 4: Example of motor size adaptation

NORD motor size	Attachment SK 1x0E size 1	Add-on SK 1x0E size 2
Size 63 – 71	with adapter kit I	with adapter kit I
Size 80 – 100	<i>Direct mounting</i>	<i>Direct mounting</i>

**Overview of adapter kits**

Adapter kit		Name	Components	Part No.
Adapter kit I	IP55	SK T14-12-Adapter kit_63-71	Adapter plate, terminal box frame seal and screws	275119050
	IP66	SK T14-12-Adapter kit_63-71-C		275274324

**2.1.1.2 Dimensions, SK 1x0E mounted on motor**

Size		Housing dimensions SK 1x0E / Motor					Weight of SK 1x0E without motor approx. [kg]
FI	Motors	Ø g	g 1	n	o	p	
Size 1	Size 63 <sup>1)</sup>	130	177.0	221	192	154	2.9
	Size 71 <sup>1)</sup>	145	177.5		214		
	Size 80	165	171.5		236		
	Size 90 S / L	183	176.5		251 / 276		
Size 2	Size 80	165	196.5	255	236	165	4.1
	Size 90 S / L	183	201.5		251 / 276		
	Size 100	201	210.5		306		

All dimensions in [mm]  
<sup>1)</sup> including additional adapter and seal (18 mm) [275119050]

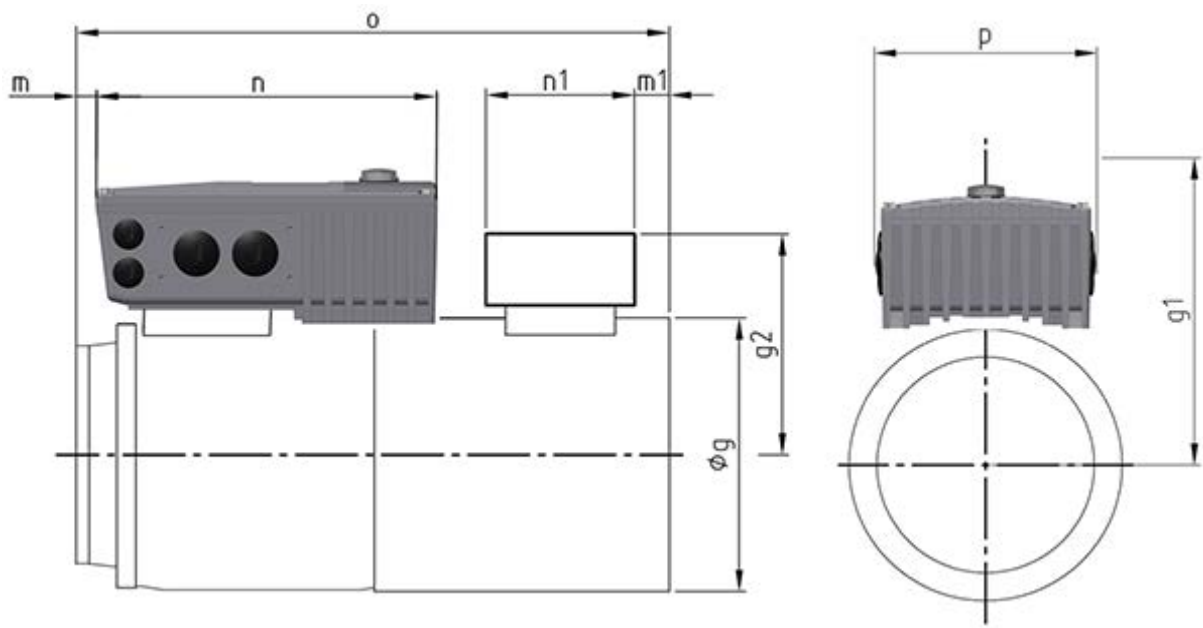

## 2.1.2 Wall mounting

As an alternative to wall mounting, the device can also be installed close to the motor using an optional wall-mounting kit.

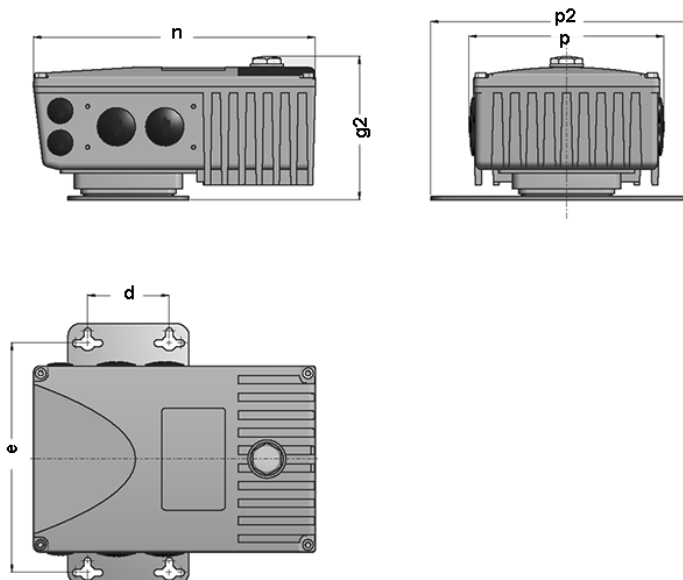

### Wall mounting kit SK TI4-WMK-... (...1-K)

This wall-mounting kit provides a simple method for installing the device close to the motor. The SK TIE4-WMK-1-K version is made of plastic. It is equally suitable for IP55 and IP66 devices. Any installation position is permissible with wall mounting, taking the electrical data into consideration.

Size of device	Wall mounting kit	Housing dimensions				Mounting dimensions			Total Weight Approx. [kg]
		g2	n	p	p2	d	e	Ø	
Size 1	SK TIE4-WMK-1-K Part. No. 275 274 004	113	221	154	205	64	180	5.5	2.2
Size 2	SK TIE4-WMK-1-K Part. No. 275 274 004	136	254	165	205				3.5
All dimensions in [mm]									

### Wall mounting kit SK TIE4-WMK-1-EX

This wall mounting kit is intended for use in explosion hazard environments (see Section 2.5 "Operation in potentially explosive environments "). It is made of stainless steel and is equally suitable for IP55 and IP66 devices

## 2 Assembly and installation

Size of device	Wall mounting kit	Housing dimensions				Mounting dimensions			Total Weight Approx. [kg]
		g2	n	p	p2	d	e	Ø	
<b>Size 1</b>	SK TIE4-WMK-1-EX Part. No. 275 175 053	113	221	154	205	64	180	5.5	2.6
<b>Size 2</b>	SK TIE4-WMK-1-EX Part. No. 275 175 053	136	254	165	205				3.9
All dimensions in [mm]									

## 2.2 Installation of optional modules

Modules must not be inserted or removed unless the device is free of voltage. The slots may only be used for the intended modules.

### 2.2.1 Option locations on device

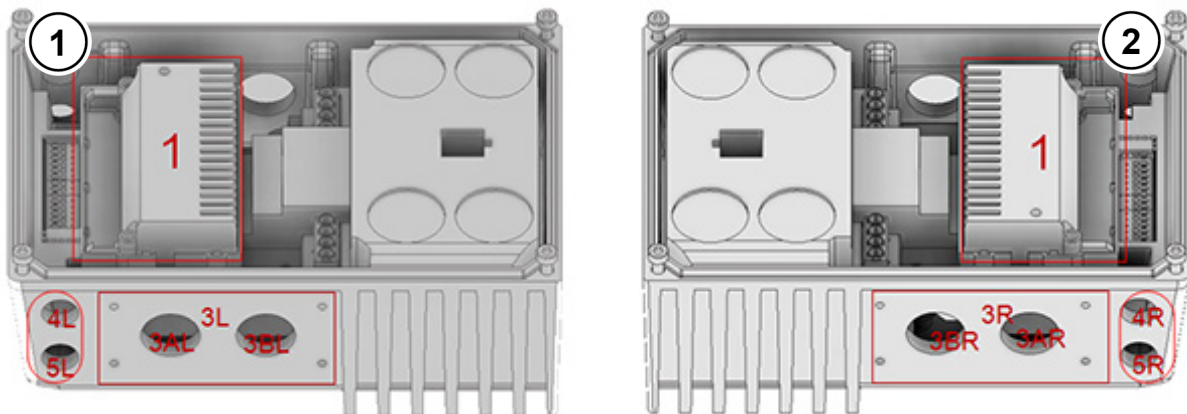

Figure 5: Option locations, size 1

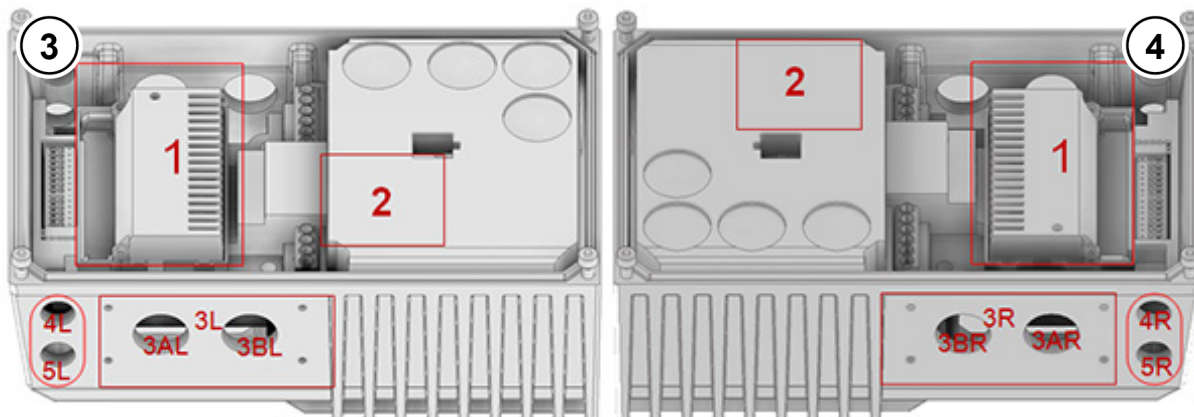
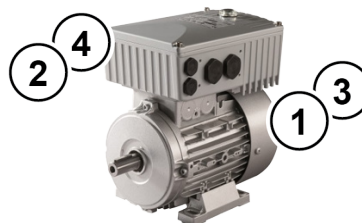

Figure 6: Option locations, size 2

- 1 View from left, size 1
- 2 View from right, size 1
- 3 View from left, size 2
- 4 View from right, size 2



The various installation locations for the optional modules are drawn into the drawings shown above. Option location 1 is used to install an internal bus module.

An internal braking resistor can be installed in mounting location 2 (only available in size 2). **The braking resistor cannot be retrofitted and must therefore be taken into account in the order.**

External bus modules or 24 V power supplies can be implemented at option location 3L or 3R. The same applies to external braking resistors. Option locations 4 and 5 are used to install M12 sockets or connectors or also for cable glands. Only one option can be attached in an option location, of course.

Option location	Position	Meaning	Size	Comments
1	Internal	Mounting location for customer units SK CU4-...		
2	Internal	Mounting location for internal braking resistor		Only for size 2
3*	on side	Mounting location for <ul style="list-style-type: none"> <li>External technology box SK TU4-...</li> <li>External braking resistor SK BRE4-...</li> <li>Power connector</li> </ul>		
3 A/B*	on side	Cable gland	M25	Not available if location 3 is occupied or SK TU4-... is fitted.
4* 5*	on side	Cable gland	M16	Not available if SK TU4-... is fitted.
* R and L (right and left side) – with engine installation: Viewing direction from impeller to motor shaft				

## 2.2.2 Installation of internal customer unit SK CU4-... (installation)



### Information

### Installation location of customer unit

Installation of the SK CU4-... customer unit **separately** from the device is not permitted. It must always be installed inside the device in the intended position (option location 1). Only one customer unit can be installed per device!

Prefabricated cables are provided with the customer unit.

Connections are made according to the following table:



Similar to illustration  
Bag enclosed with internal customer unit

### Allocation of the cable sets (accessories supplied with customer unit)

	Function		Terminal label	Cable colour
	Voltage supply (24V DC) (between device and customer unit)	44	24V	brown
		40	GND/0V	blue
	System bus	77	SYS H (+)	black
		78	SYS L (-)	grey

The bus modules require a 24V supply voltage.

The customer units are installed inside the housing box of the device.

The customer unit is secured with two screws provided.

Only one customer unit per device is possible!

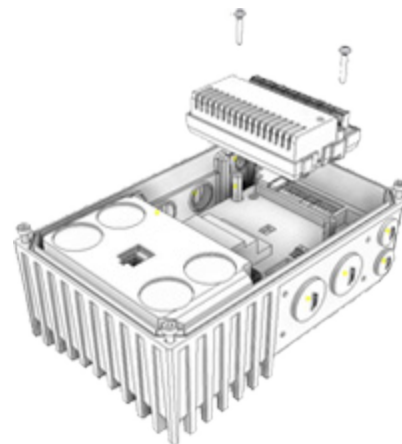



### 2.2.3 Installation of external technology units SK TU4-... (attachment)

The technology units SK TU4-...(-C) require a connection unit SK TI4-TU-...(-C). This is the only way to create a closed functional unit. This can be attached to the device or installed separately by means of the optional SK TIE4-WMK-TU wall-mounting kit. In order to provide reliable operation, cable lengths of more than 20 m between the technology unit and the device must be avoided.



#### Information

#### Detailed installation information

A detailed description can be found in the documents for the connection unit concerned.

Connection unit	Document
SK TI4-TU-BUS	<a href="#">TI 275280000</a>
SK TI4-TU-BUS-C	<a href="#">TI 275280500</a>
SK TI4-TU-NET	<a href="#">TI 275280100</a>
SK TI4-TU-NET-C	<a href="#">TI 275280600</a>
SK TI4-TU-MSW	<a href="#">TI 275280200</a>
SK TI4-TU-MSW-C	<a href="#">TI 275280700</a>

## 2.3 Braking resistor (BW) - (from size 2)

During dynamic braking (frequency reduction) of a three-phase motor, electrical energy is returned to the inverter if necessary. **From size 2 and above**, an internal or external braking resistor can be used to avoid a shut-down of the device due to overvoltage. With this, the integrated brake chopper (electronic switch) pulses the link circuit voltage (switching threshold approx. 420 V / 720 V<sub>DC</sub>, depending on mains voltage) into the braking resistor. The braking resistor converts excess energy into heat.

### CAUTION

#### Hot surfaces

The braking resistor and all other metal components can heat up to temperatures above 70 °C.

- Danger of injury due to local burns on contact.
- Heat damage to adjacent objects

Allow sufficient cooling time before starting work on the product. Check the surface temperatures with suitable measuring equipment. Maintain an adequate distance to adjacent components or provide protection against contact.

### 2.3.1 Internal braking resistor SK BRI4-...

The internal braking resistor can be used if only slight, short braking phases are to be expected.

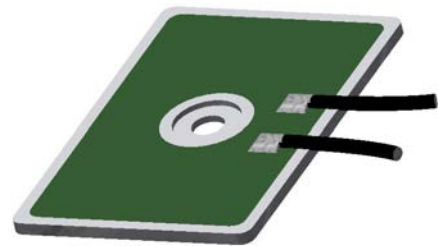

Similar to illustration

- The braking resistor **cannot be retrofitted** and must therefore be taken into account in the order.
- The output power of the braking resistor is limited and can be calculated as follows.

$$P = P_n * (1 + \sqrt{(30 / t_{brms})})^2, \text{ however, the following applies } P < P_{max}$$

- (P=Brake power (W), P<sub>n</sub>= Continuous brake power of resistor (W), P<sub>max</sub>. peak brake power, t<sub>brake</sub> = duration of braking process (s))
- (For details of P<sub>n</sub> and P<sub>max</sub> see  Section 0 "Electrical data")
- The permissible continuous brake power P<sub>n</sub> must not be exceeded in the long-term average.
- The peak and continuous powers must be limited by adjusting the parameter settings.

#### Required parameter settings

A braking resistor is installed by default in certain versions of the device. As delivered, the relevant parameters for limitation of the peak and continuous powers are pre-set (refer to the following tables).

### NOTICE!

### Damage due to incorrect parameterisation

Incorrect settings of parameters (P555), (P556) and (P557) impair the correct function of the braking resistor and may destroy both this and the frequency inverter.

After setting the parameter "Factory Setting" (P523) to one of the functions 1, 2 or 3, it is essential to reset parameters (P555), (P556) and (P557) to the correct values.

SK 1x0E-750-323-B(-C)-BRI    SK 1x0E-111-323-B(-C)-BRI    SK 1x0E-151-323-B(-C)-BRI			
Parameter number	Meaning	Setting [Unit]	Comments
P555	P - chopper limit	100 [%]	Power limit <sup>1)</sup>
P556	Braking resistor	200 [ $\Omega$ ]	Electrical resistance <sup>1)</sup>
P557	Braking resistor power	0.05 [kW]	Max. continuous power $P_n$ <sup>1)</sup>

1) of braking resistor

SK 1x0E-151-340-B(-C)-BRI    SK 1x0E-221-340-B(-C)-BRI			
Parameter number	Meaning	Setting [Unit]	Comments
P555	P - chopper limit	65 [%]	Power limit <sup>1)</sup>
P556	Braking resistor	400 [ $\Omega$ ]	Electrical resistance <sup>1)</sup>
P557	Braking resistor type	0.05 [kW]	Max. continuous power $P_n$ <sup>1)</sup>

1) of braking resistor

### Electrical data

Designation	Electrical resistance	Max. continuous output / limit <sup>2)</sup> $(P_n)$	Power consumption <sup>1)</sup> $(P_{max})$
SK BRI4-1-200-100 <sup>3)</sup>	200 $\Omega$	100 W / 25 %	1.0 kW
SK BRI4-1-400-100 <sup>4)</sup>	400 $\Omega$	100 W / 25 %	1.0 kW
	1) Maximum once within 10 s <sup>2)</sup> 2) In order to prevent impermissible heating of the frequency inverter, the continuous power is limited to 1/4 of the rated power of the braking resistor. This also has a limiting effect on the energy consumption. 3) Only for Size 2 devices with a rated voltage of 230 V. 4) Only for Size 2 devices with a rated voltage of 400 V.		

### 2.3.2 External braking resistor SK BRE4-... / SK BRW4-... / SK BREW4-...

The external braking resistor is provided for energy feedback, e.g. as occurs in pulsed drive units or lifting gear. Here, it may be necessary to plan for the exact braking resistor that is required (see adjacent figure).

Installation of an SK BRE4-... is not possible in combination with the wall-mounting kit **SK TIE4-WMK....** In this case, braking resistors of type **SK BREW4-...** are available as an alternative, which can also be fitted to the frequency inverter.



In addition **SK BRW4-...** type brake resistors are available for mounting on a wall near to the device.

## Electrical data

Designation <sup>1)</sup> (IP67)	Resistance	Max. continuous power (P <sub>n</sub> )	Energy consumption <sup>2)</sup> (P <sub>max</sub> )
SK BRx4-1-100-100	100 Ω	100 W	2.2 kW
SK BRx4-1-200-100	200 Ω	100 W	2.2 kW
SK BRx4-1-400-100	400 Ω	100 W	2.2 kW
SK BRx4-2-100-200	100 Ω	200 W	4.4 kW
SK BRx4-2-200-200	200 Ω	200 W	4.4 kW
1) SK BRx4-: versions: SK BRE4-, SK BRW4-, SK BREW4- 2) Maximum once within 120s			

## Information

### Braking resistor

If required, other versions or installation variants for external braking resistors can be provided.

### Braking resistor assignments

The braking resistors provided by NORD are directly tailored to the individual devices. However, when external braking resistors are being used, it is usually possible to select between 2 or 3 alternatives.

**Note:** The internal braking resistor (SK BRI4-) cannot be retrofitted! The resistor must be taken into consideration when ordering the frequency inverter. In this case, the frequency inverter is given a separate material number and marking **-BRI** at the end of the type key (for example **SK 180E-151-340-B-C-BRI**).

Device SK 1x0E-...	Internal braking resistor	External		
		Preferred braking resistor	alternative braking resistor	Alternative braking resistor
750-323-A	SK BRI4-1-200-100	SK BRx4-1-100-100	SK BRx4-2-200-200	SK BRx4-2-100-200
111-323-A	SK BRI4-1-200-100	SK BRx4-1-100-100	SK BRx4-2-200-200	SK BRx4-2-100-200
151-323-A	SK BRI4-1-200-100	SK BRx4-1-100-100	SK BRx4-2-200-200	SK BRx4-2-100-200
151-340-A	SK BRI4-1-400-100	SK BRx4-1-200-100	SK BRx4-2-400-200	SK BRx4-2-200-200
221-340-A	SK BRI4-1-400-100	SK BRx4-1-200-100	SK BRx4-2-400-200	SK BRx4-2-200-200

1) SK BRx4-: versions: SK BRE4-, SK BRW4-, SK BREW4-

**Table 5: Assignment of braking resistors to frequency inverter**

### 2.4 Electrical Connection

#### WARNING

##### Electric shock

Dangerous voltages can be present at the mains input and the motor connection terminals, even when the device is not in operation.

- Before starting work, check that all relevant components (voltage source, connection cables, connection terminals of the device) are free of voltage using suitable measuring equipment.
- Use insulated tools (e.g. screwdrivers).
- DEVICES MUST BE EARTHED.

#### Information

##### Temperature sensor and PTC (TF)

As with other signal cables, thermistor cables must be laid separately from the motor cables. Otherwise the interfering signals from the motor winding that are induced into the line affect the device.

Ensure that the device and the motor are specified for the correct supply voltage.

The housing cover must be removed from the device in order to make the electrical connection ( Section 2.1.1 "Work procedures for motor installation").

One terminal level is provided for the power connections and one for the control connections.

The PE connections (device earth) are located on the power connections for the motor and the mains, as well as on the base inside the cast housing.

The terminal strip assignments differ according to the version of the device. The correct assignment can be found on the inscription on the respective terminal or the terminal overview plan printed inside the device.

	Connecting terminals for
(1)	Power cable (X1.1)
(2)	Motor cable (X2.1)
(3)	Braking resistor lines (size 2 only)
(4)	Control lines (X4)
(5)	Control lines (X5) (SK 190E only)
(6)	PTC thermistor (TF) from motor (X3)
(7)	PE (X1.2 or X2.2)

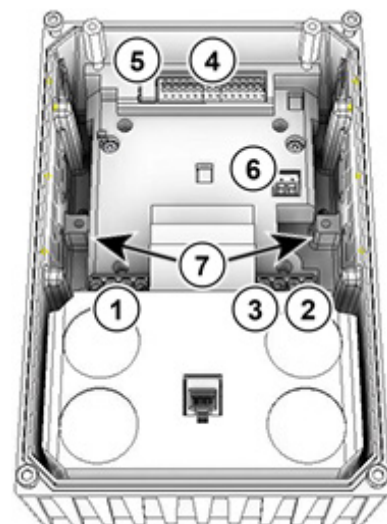

### 2.4.1 Wiring guidelines

The soft starters have been developed for use in an industrial environment. In this environment, electromagnetic interference can affect the device. In general, correct installation ensures safe and problem-free operation. To meet the limiting values of the EMC directives, the following instructions should be complied with.

1. Ensure that all devices are securely earthed to a common earthing point or earthing rail using short earthing cables with a large cross-section. It is especially important that each control unit which is connected to the electronic drive technology (e.g. an automatic device) has a short cable with a large cross-section, which is connected to the same earthing point as the device itself. Flat cables (e.g. metal stirrups) are preferable, as they have a lower impedance at high frequencies.
2. The bonding cable of the motor controlled by the soft starter should be connected directly to the earthing terminal of the associated device. The presence of a central earthing bar in the control cabinet and the grouping together of all bonding conductors to this bar normally ensures safe operation.
3. Where possible, shielded cables should be used for control circuits. The shielding at the cable end should be carefully sealed and it must be ensured that the wires are not laid over longer distances without shielding.

The shields of analogue setpoint cables should only be earthed on one side on the device.

4. The control cables should be installed as far as possible from power cables, using separate cable ducts, etc. Where cables cross, an angle of 90° should be ensured as far as possible.
5. Ensure that the contactors in the cabinet are interference protected, either by RC circuits in the case of AC contactors or by free-wheeling diodes for DC contactors, for which **the interference traps must be positioned on the contactor coils**. Varistors for over-voltage limitation are also effective.
6. Shielded or armoured cables should be used for the load connections (motor cable if necessary). The shielding or armouring must be earthed at both ends. The earthing should be provided directly to the PE of the device if possible.

In addition, EMC-compliant wiring must be ensured.

**The safety regulations must be complied with under all circumstances when installing the devices!**

#### **NOTICE!**

##### **Damage due to high voltage**

The device may be damaged by electrical loads which do not correspond to its specification.

- Do not perform any high voltage tests on the device itself.
- Disconnect the cable which is to be tested from the device before performing a high voltage insulation test.

##### **Information**

##### **Looping of the mains voltage**

The permissible current load for the connection terminals, plugs and supply cables must be observed when looping the mains voltage. Failure to comply with this will result in thermal damage to current-carrying modules and the immediate vicinity thereof.

If the device is installed according to the recommendations in this manual, it meets all EMC directive requirements, as per the EMC product standard EN 61800-3.

### 2.4.2 Electrical connection of power unit

#### NOTICE!

##### EMC Interference to the environment

This device produces high frequency interference, which may make additional suppression measures necessary in domestic environments (📖 Section 8.3 "Electromagnetic compatibility (EMC)").

- Use of shielded motor cables is essential in order to comply with the specified radio interference suppression level.

When the device is being connected, please note the following:

1. Ensure that the mains supply provides the correct voltage and is suitable for the current required (📖 Section 7 "Technical data").
2. Ensure that suitable electrical fuses with the specified nominal current range are installed between the voltage source and the device.
3. Mains cable connection: to terminals **L1-L2/N-L3** and **PE** (depending on device)
4. Motor connection: to terminals **U-V-W**

A 4-core motor cable must be used if the device is being wall-mounted As well as **U-V-W**, **PE** must also be connected. If present, in this case the cable shielding must be connected to a large area of the metallic screw connector of the cable gland.

The use of wire end rings is recommended for connecting to PE.



#### Information

#### Connection cables

Only use copper cables with temperature class 80°C or equivalent for connection. Higher temperature classes are permissible.

When using **wiring sleeves**, the maximum connection cross-section can be reduced.

Device	Cable Ø [mm²]		AWG	Tightening torque	
	rigid	flexible		[Nm]	[lb-in]
1 ... 2	0.2 ... 4	0.2 ... 6	24-10	0.5 ... 0.6	4.42 ... 5.31
<b>Electromechanical brake</b>					
1 ... 2	0.2 ... 2.5	0.2 ... 2.5	24-14	0.5 ... 0.6	4.42 ... 5.31

Table 6: Connection data

#### 2.4.2.1 Mains supply (L1, L2(/N), L3, PE)

No special safety measures are required on the mains input side of the device. It is advisable to use normal mains fuses (see technical data) and a main switch or circuit breaker.

Frequency inverter data			Permissible mains data			
Type	Voltage	Power	1 ~ 115 V	1 ~ 230 V	3 ~ 230 V	3 ~ 400 V
SK...112-O	115 VAC	0.25 ... 0.75 kW	X			
SK...323-B	230 VAC	0.25 ... 1.10 kW		X	X	
SK...323-B	230 VAC	1.50 kW			X	
SK...340-B	400 VAC	≥ 0.25 kW				X
<b>Connections</b>			<b>L/N = L1/L2</b>	<b>L/N = L1/L2</b>	<b>L1/L2/L3</b>	<b>L1/L2/L3</b>

Isolation from or connection to the mains must always be carried out for all poles and synchronously (L1/L2/L3 or L1/N).

As delivered, the device is configured for operation in TN or TT networks. With this, the mains filter has its normal effect and leakage current. A network that is earthed in the neutral point must be used, and with single-phase devices a zero conductor must be used!

**Adaptation to IT networks – (from size 2)**

**⚠ WARNING**

**Unexpected movement in case of mains faults**

In case of a mains fault (short circuit to earth) a frequency inverter which is switched off may switch on automatically. Depending on the parameterisation, this may cause the drive unit to start automatically and therefore cause a risk of injury.

- Secure the system against unexpected movement (block, decouple mechanical drive, provide protection against falling, etc.)

**NOTICE!**

**Operation on IT network (Size 2 and above)**

If a mains fault (short-circuit to earth) occurs in an IT network, the link circuit of a connected frequency inverter may become charged. This results in destruction of the link circuit capacitors due to overcharging.

- Connect a brake resistor to dissipate excess energy.

For operation on the IT network, simple adaptations must be carried out by relocating the jumpers (C<sub>v</sub>=OFF), which may result in impairment of the radio interference suppression.

The insulation resistance of the frequency inverter must be taken into consideration when operating on an insulation monitor (📖 Section 7 "Technical data").

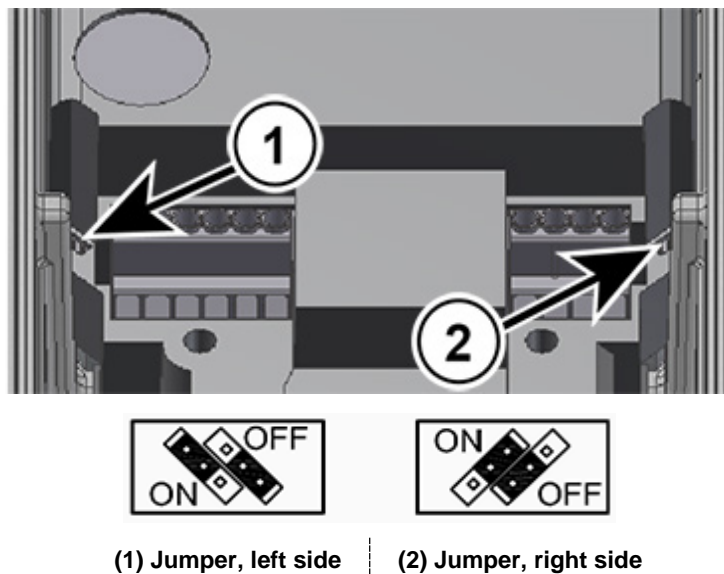

**Figure 7: Jumpers for mains adaptation**

**Use with differing supply networks or network types**

The frequency inverter may only be connect to and operated in supply networks which are explicitly stated in this section (📖 Section 2.4.2.1 "Mains supply (L1, L2(/N), L3, PE)"). Operation in **deviating network types** may be possible, but must be **explicitly checked and approved by the manufacturer in advance**.



### 2.4.2.2 Motor cable

The motor cable may have a **total length of 50 m** if it is a standard cable type (observe EMC). If a shielded motor cable is used or if the cable is installed in a metallic and well grounded duct, the total length should not exceed **20 m** (connect cable shield to PE at both ends).

#### **NOTICE!**

##### **Output switching**

Switching a motor cable under load causes an impermissible increase of the load on the device. Components in the power section may be damaged and destroyed either immediately or in the long term.

- Only switch the motor cable when the frequency inverter is no longer pulsing. I.e. the device must be in the state "ready for switch-on" or "switch-on block".



#### **Information**

##### **Synchronous motors or multiple motor operation**

If synchronous motors or several motors are connected in parallel to an FI, the frequency inverter must be switched over to linear voltage/frequency characteristic curves, (→ P211 = 0 and P212 = 0).

For multiple motor operation the total motor cable length consists of the sum of the individual motor cable lengths.

### 2.4.2.3 Braking resistor (+B, -B) – (from size 2)

The terminals +B/ -B are intended for the connection of a suitable braking resistor. A short screened connection should be selected.



#### **CAUTION**

##### **Hot surfaces**

The braking resistor and all other metal components can heat up to temperatures above 70 °C.

- Danger of injury due to local burns on contact.
- Heat damage to adjacent objects

Allow sufficient cooling time before starting work on the product. Check the surface temperatures with suitable measuring equipment. Maintain an adequate distance to adjacent components or provide protection against contact.

### 2.4.3 Electrical connection of the control unit

#### Connection data:

Terminal bar		X3	X4, X5
Cable Ø *	[mm²]	0.2 ... 1.5	0.2 ... 1.5
Ø cable *	[mm²]	0.2 ... 0.75	0.2 ... 0.75
AWG standard		24-16	24-16
Tightening torque	[Nm]	0.5 ... 0.6	Clamping
	[lb-in]	4.42 ... 5.31	
Slotted screwdriver	[mm]	2.0	2.0

\* Flexible cable with wire-end ferrules, **without** plastic collar or rigid cable

\*\* Flexible cable with wire-end ferrules with plastic collar (for cable cross-section 0.75 mm², a wire-end ferrule with a length of 10 mm must be used)

The device generates its own control voltage and provides this to terminal 43 (e.g. for connection of external sensor systems).

#### Information

#### Control voltage overload

A control unit overload caused by impermissibly high currents may destroy the unit. Impermissibly high currents occur if the total current that is actually withdrawn exceeds the permissible total current.

The control unit can also be overloaded and destroyed if the 24 V DC supply terminals of the device are connected to a different voltage source. For this reason, particularly when installing connectors for the control connection, it must be ensured that any cores for the 24 V DC power supply are not connected to the device but are insulated accordingly (example of connector for system bus connection SK TIE4-M12-SYSS).

#### Information

#### Total currents

If necessary, 24 V can be drawn from several terminals. This also includes e.g. digital outputs or an operating module connected via RJ45

The total current which is drawn off must not exceed 150 mA.

#### Information

#### Reaction time of digital inputs

The reaction time of a digital signal is approx. 4-5 ms and consists of the following:

Scan time	1 ms
Signal stability check	3 ms
Internal processing	< 1 ms

#### Information

#### Cable laying

All control cables (including thermistors) must be routed separately from the mains and the motor cables to prevent interference in the device.

If the cables are routed in parallel, a minimum distance of 20 cm must be maintained from cables which carry a voltage of > 60 V. The minimum distance may be reduced by screening the cables which carry a voltage, or by the use of earthed metal partitions within the cable conduits.

Alternatively: Use a hybrid cable with shielding of the control lines.

### 2.4.3.1 Control terminal details

#### Labelling, function

AIN:	Analogue input	DO:	Digital output
ASI+/-:	Integrated AS interface	DIN:	Digital input
10 V:	10 V DC reference voltage for AIN	SYS+/-:	System bus
24 V:	24 V DC control voltage	TF+/-:	Motor thermistor (PTC) connection
GND:	Reference potential for analogue and digital signals		

#### Connections depending on the development stage

##### Terminal X3:

Device type		SK 180E	SK 190E ASI
Pin	Labelling		
1	39	TF-	
2	38	TF+	

##### Terminal X4

Device type		SK 180E	SK 190E ASI
Pin	Labelling		
1	11	10V	
2	14	AIN1	
3	16	AIN2	
4	40	GND	
5	43	24V (output)	
6	21	DIN1	
7	22	DIN2	
8	23	DIN3	
9	1	DO1	
10	40	GND	
11	3	DO2	
12	40	GND	
13	77	SYS+	
14	78	SYS-	



##### Terminal X5 (only SK 190E):

Device type		SK 180E	SK 190E ASI
Pin	Labelling		
1	84		ASI+
2	85		ASI-

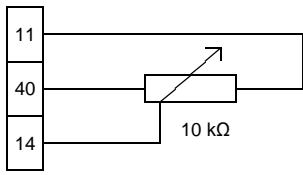
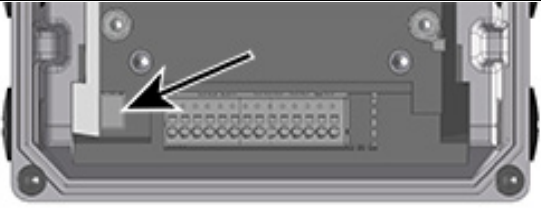
Meaning, Functions		Description / Technical data			
Terminal				Parameter	
No.	Designation	Meaning	No.	Function of factory setting	
<b>Digital outputs</b>		Signalling of device operating statuses			
		24 V DC With inductive loads: Provide protection via free-wheeling diode!	Maximum load 20 mA		
1	DOUT1	Digital output 1	P434 [-01]	Fault	
3	DOUT2	Digital output 2	P434 [-02]	Fault	

<b>Analogue inputs</b>		Actuation of device by external controller, potentiometer or the like.		
		<i>Resolution</i> 12Bit $U = 0 \dots 10 \text{ V}$ , $R_i = 30 \text{ k}\Omega$ $I = 0/4 \dots 20 \text{ mA}$ <i>Burden resistance</i> (250 $\Omega$ ) via DIP switch AIN1/2  Maximum permissible voltage at analogue input: 30 V DC	Matching of the analogue signals is performed via P402 and P403. + 10 V Reference voltage: 5 mA not short-circuit resistant	
				
11	10V REF	+ 10 V Reference voltage	-	-
14	AIN1+	Analogue input 1	P400 [-01]	Setpoint frequency
16	AIN2+	Analogue input 2	P400 [-02]	No function
40	GND	Reference potential GND	-	-
<b>Digital inputs</b>		Actuation of device using an external controller, switch or the like.		
		<b>as per EN 61131-2 Type 1</b> Low: 0-5 V (~ 9.5 k $\Omega$ ) High: 15-30 V (~ 2.5 - 3.5 k $\Omega$ )	<i>Scan time:</i> 1 ms <i>Reaction time:</i> $\geq 4 \text{ ms}$ <i>Input capacitance:</i> 10 nF	
21	DIN1	Digital input 1	P420 [-01]	ON right
22	DIN2	Digital input 2	P420 [-02]	ON left
23	DIN3	Digital input 3	P420 [-03]	Fixed frequency 1 ( $\rightarrow$ P465[-01])
<b>Note:</b> Inputs DIN2 and DIN3 react more quickly than DIN 1				
<b>PTC resistor input</b>		Monitoring of motor temperature using PTC		
		If the device is installed near the motor, a shielded cable must be used.	The input is always active. In order to make the device operational, a temperature sensor must be connected or both contacts must be jumpered.	
38	TF+	PTC resistor input	-	-
39	TF-	PTC resistor input	-	-
<b>Control voltage source</b>		Control voltage of device, e.g. for supplying accessories.		
		24 V DC $\pm$ 25 %, short circuit-proof	Maximum load 150 mA <sup>1)</sup>	
43	VO / 24V	Voltage output	-	-
40	GND / 0V	Reference potential GND	-	-
1) See "Total currents" information (☞ Section 2.4.3 "Electrical connection of the control unit")				
<b>System bus</b>		NORD-specific bus system for communicating with other devices (e.g. smart option modules or frequency inverter)		
		Up to four frequency inverters (SK 2xxE, SK 1x0E) can be operated on a single system bus.	$\rightarrow$ Address = 32 / 34 / 36 / 38	
77	SYS H	System bus+	P509/510	Control terminals / Auto
78	SYS L	System bus-	P514/515	250kBaud / Address 32 <sub>dec</sub>
<b>System bus termination resistor</b>		Termination at the physical ends of the bus system		
		<b>The correct setting of the termination resistors must be checked before commissioning. (1x at the beginning and 1x at the end of a system bus connection)</b>		
S1				Factory setting "ON"  (For deviating factory setting, see explanation above)
<b>AS Interface</b>		Control of device via simple field bus level: Actuator/sensor interface		
		26.5 – 31.6 V $\leq 25 \text{ mA}$	Only usable for yellow AS interface cable, feed via black cable not possible.	
84	ASI+	ASI+	P480 ...	-
85	ASI-	ASI-	P483	-

## 2 Assembly and installation

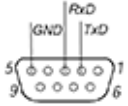
<b>Communication interface</b>		Device connected to different communication tools		
		24 VDC $\pm$ 20%	RS 485 (For connecting a parametrisation box) 9600 ... 38400 Baud <i>Terminating resistance</i> (1 k $\Omega$ ) fixed RS 232 (For connecting to a PC (NORD CON)) 9600 ... 38400 Baud	
1	RS485 A+	Data cable RS485	P502... P513 [-02]	 1 - 2 - 3 - 4 - 5 - 6
2	RS485 B-	Data cable RS485		
3	GND	Reference potential of bus signals		
4	RS232 TXD	Data cable RS232		
5	RS232 RXD	Data cable RS232		
6	+24 V	Voltage output		
<b>Connection cables (accessories / optional)</b>		Connection of the device to an MS-Windows® PC with NORDCON software		
		<i>Length:</i> approx. 3.0 m + approx. 0.5 m <i>Part number:</i> 275274604 Suitable for connection to a USB port in a PC or alternatively to a SUB-D9 connection. Details: <a href="#">TI 275274604</a>		

## 2.5 Operation in potentially explosive environments



### WARNING

#### Danger of explosion due to electricity

Electric sparks may ignite an explosive atmosphere.

- Do not open the device in an explosive atmosphere and do not remove any covers (e.g. diagnostic openings).
- All work on the device must only be carried out with the **power to the system switched off**.
- Wait for the required time ( $\geq 30$  min) after switching off.
- Before starting work, check that all relevant components (voltage source, connection cables, connection terminals of the device) are free of voltage using suitable measuring equipment.



### WARNING

#### Explosion hazard due to high temperatures

High temperatures may cause the ignition of an explosive atmosphere.

Temperatures may occur within the device and the motor, which are higher than the maximum permissible surface temperature of the housing. Dust deposits may restrict the cooling of the device.

- Clean the device at regular intervals to prevent the accumulation of impermissible dust deposits.
- Do not open or remove the device from the motor in an explosive atmosphere.

With appropriate modification, the device can be used in certain potentially explosive areas.

If the device is connected to a motor and a gear unit, the EX labelling of the motor and the gear unit must also be observed. Otherwise the drive must not be operated.

### 2.5.1 Operation in potentially explosive environments - ATEX zone 22 3D

All of the conditions which must be observed for operation of the frequency inverter in an explosion hazard environment (ATEX) are listed below.

#### 2.5.1.1 Modification of the device for compliance with category 3D

Only a specially modified device is permitted for operation in ATEX zone 22. This adjustment is exclusively made at the NORD site. In order to use the device in the ATEX zone 22, the diagnostic caps are replaced with anodised oil inspection glasses, among other things.



( 1 ) Year of manufacture

( 2 ) Labelling of the device (ATEX)

IP55:  II 3D Ex tc IIIB T125 °C Dc X

IP66:  II 3D Ex tc IIIC T125 °C Dc X

**Assignment:**

- Protected by a “housing”
- Method “A” Zone “22” Category 3D
- Protection class IP55/IP66 (depending on the device)
  - IP66 required for conductive dust
- Maximum surface temperature 125 °C
- Ambient temperature -20 °C to +40 °C

### Information

#### Possible damage caused by mechanical overload

Devices of the SK 1x0E series and the approved options are only designed for a degree of mechanical load which corresponds to a low impact energy of 7J.

Higher loads result in damages to or in the device.

The necessary components for making adaptations are contained in the ATEX kits.

Device	Kit designation	Part Number	Quantity	Document
SK 1x0E-... (IP55)	SK 1xxE-ATEX-IP55	275274207	1	<a href="#">TI 275274207</a>
SK 1x0E-...-C (IP66)	SK 1xxE-ATEX-IP66	275274208	1	<a href="#">TI 275274208</a>

#### 2.5.1.2 Options for ATEX Zone 22, category 3D

In order to ensure that the device is ATEX-compliant, its optional modules must also be approved for potentially explosive areas. Option modules that are not in the following list may **not** be used in an ATEX zone 22 3D. This also includes connectors and switches that may also not be used in such an environment.

**Control and parametrisation units** are basically **not** approved for **operation in ATEX zone 22 3D**. They may therefore only be used for commissioning or maintenance purposes and if it has been ensured that no explosive dust atmosphere exists.

Designation	Part Number	Use permitted
<b>Braking resistors</b>		
SK BRI4-1-100-100	275272005	Yes
SK BRI4-1-200-100	275272008	Yes
SK BRI4-1-400-100	275272012	Yes

<b>Bus interfaces</b>		
SK CU4-CAO(-C)	275271001 / (275271501)	Yes
SK CU4-DEV(-C)	275271002 / (275271502)	Yes
SK CU4-ECT(-C)	275271017 / (275271517)	Yes
SK CU4-EIP(-C)	275271019 / (275271519)	Yes
SK CU4-PBR(-C)	275271000 / (275271500)	Yes
SK CU4-PNT(-C)	275271015 / (275271515)	Yes
SK CU4-POL(-C)	275271018 / (275271518)	Yes
<b>IO -Extensions</b>		
SK CU4-IOE(-C)	275271006 / (275271506)	Yes
SK CU4-IOE2(-C)	275271007 / (275271507)	Yes
SK CU4-REL(-C)	275271011 / (275271511)	Yes
<b>Potentiometers</b>		
SK ATX-POT	275142000	Yes
<b>Miscellaneous</b>		
SK CU4-FUSE(-C)	275271122 / (275271622)	Yes
SK CU4-MBR(-C)	275271010 / (275271510)	Yes
<b>Wall mounting kits</b>		
SK TIE4-WMK-1-EX	275175053	Yes
<b>Adapter kits</b>		
SK TI4-12-Adapter kit_63-71-EX	275175038	Yes

### SK ATX-POT

The Category 3D frequency inverter can be equipped with an ATEX-compliant 10 k $\Omega$  potentiometer (SK ATX-POT), which can be used to setpoint (e.g. speed) adjustment on the device. The potentiometer is used with an M20-M25 extension in one of the M25 cable glands. The selected setpoint can be adjusted with a screwdriver. Due to the detachable screw closing cap, this component complies with ATEX requirements. Permanent operation may only be carried out with the cap closed.

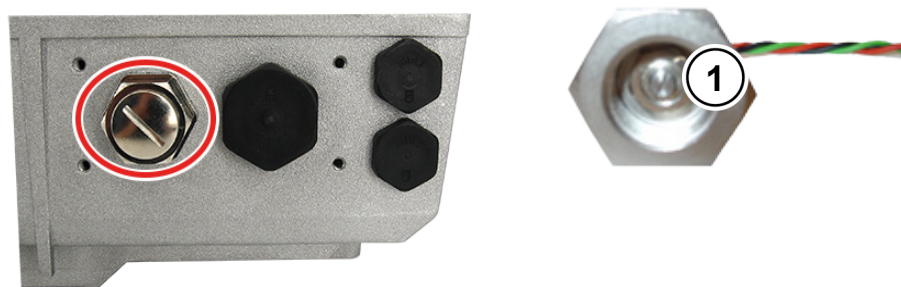

1 Setting adjustment using a screwdriver

SK ATX-POT wire colour	Name	Terminal SK CU4-24V...	Terminal SK CU4-IOE	Terminal SK 1x0E
red	+10 V reference	[11]	[11]	[11]
black	AGND / 0V	[12]	[12]	[12] / [40]
green	Analogue input	[14]	[14] / [16]	[14] / [16]



### **i** Information

### Internal braking resistor "SK BRI4-..."

If an internal braking resistor of type SK BRI4-x-xxx-xxx is used, the power limitation for this must be activated under all circumstances (see Section 2.3.1 "Internal braking resistor SK BRI4-..."). Only the resistors assigned to the relevant inverter type may be used.

#### 2.5.1.3 Maximum output voltage and torque reduction

As the maximum achievable output voltage depends on the pulse frequency to be set, in some cases the torque which is specified in document [B1091-1](#) must be reduced for values above the rated pulse frequency of 6 kHz.

For  $F_{\text{pulse}} > 6 \text{ kHz}$ :  $T_{\text{reduction}}[\%] = 1 \% * (F_{\text{pulse}} - 6 \text{ kHz})$

Therefore the maximum torque must be reduced by 1 % for each kHz pulse frequency above 6 kHz. The torque limitation must be taken into account on reaching the break frequency. The same applies for the degree of modulation (P218). With the factory setting of 100 %, in the field reduction range a torque reduction of 5 % must be taken into account:

For  $P218 > 100 \%$ :  $T_{\text{reduction}}[\%] = 1 \% * (105 - P218)$

Above a value of 105 %, no reduction needs to be taken into account. However, with values above 105 % no increase in torque above that of the Planning Guideline will be achieved. Under certain circumstances, degrees of modulation  $> 100 \%$  may lead to oscillations and motor vibration due to increased harmonics.

### **i** Information

### Power derating

At pulse frequencies above 6 kHz (400 V devices) or 8 kHz (230 V) devices, the reduction in power must be taken into account for the design of the drive unit.

If parameter (P218) is set to  $< 105 \%$ , the derating of the degree of modulation must be taken into account in the field reduction range.

#### 2.5.1.4 Commissioning information

For Zone 22 the cable glands must at least comply with protection class IP55. Unused openings must be closed with blank screw caps that are suitable for ATEX Zone 22 3D (generally IP 55).



The motors are protected from overheating by the device. This takes place by means of evaluation of the motor PTC (TF) at the device side. In order to ensure this function, the PTC must be connected to the intended input (Terminal 38/39).

In addition, care must be taken that a NORD motor from the motor list (P200) is set. If a standard 4-pole NORD motor or a motor from a different manufacturer is not used, the data for the motor parameters ((P201) to (P208)) must be adjusted to those on the motor rating plate. *The stator resistance of the motor (see P208) must be measured by the inverter and at ambient temperature. In order to do this, parameter P220 must be set to "1".* In addition, the frequency inverter must be parameterised so that the motor can be operated with a maximum speed of 3000 rpm. For a four-pole motor, the "maximum frequency" must be set to a value which is smaller or equal to 100 Hz ((P105)  $\leq 100$ ). Here the maximum permissible output speed of the gear unit must be observed. In addition, the monitoring "I<sup>2</sup>t-Motor" (Parameter (P535) / (P533)) must be switched on and the pulse frequency set to between 4 kHz and 6 kHz.

**Overview of required parameter settings:**

Parameter	Setting value	Factory setting	Description
P105 Maximum frequency	≤ 100 Hz	[50]	This value relates to a 4-pole motor. On principle, the value must only be so large that a motor speed of 3000 rpm is not exceeded.
P200 Motor list	Select appropriate motor power	[0]	If a 4-pole NORD motor is used, the pre-set motor data can be called up.
P201 – P208 Motor data	Data according to rating plate	[xxx]	If a 4-pole NORD motor is not used, the motor data on the rating plate must be entered here.
P218 Degree of modulation	≥ 100%	[100]	Determines the maximum possible output voltage
P220 Parameter identification	1	[0]	Measures the stator resistance of the motor. When the measurement is complete, the parameter is automatically reset to "0". The value that is determined is written to P208
P504 Pulse frequency	4 kHz ... 6 kHz	[6]	For pulse frequencies above 6 kHz a reduction of the maximum torque is necessary.
P533 Factor I <sup>2</sup> t-Motor	< 100%	[100]	A reduction in torque can be taken into account with values less than 100 in the I <sup>2</sup> t monitoring.
P535 I <sup>2</sup> t motor	According to motor and ventilation	[0]	The I <sup>2</sup> t- monitoring of the motor must be switched on. The set values depend on the type of ventilation and the motor used. See <a href="#">B1091-1</a>

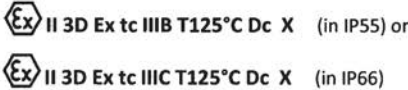
### 2.5.1.5 EU conformity declaration - ATEX

 <h1 style="margin: 0;">GETRIEBEBAU NORD</h1> <p style="margin: 0;">Member of the NORD DRIVESYSTEMS Group</p>																											
<p><b>Getriebebau NORD GmbH &amp; Co. KG</b>          Getriebebau-Nord-Str. 1, 22941 Bargteheide, Germany · Fon +49(0)4532 289 - 0 · Fax +49(0)4532 289 - 2253 · info@nord.com <span style="float: right;">C432410_1121</span></p>																											
<h2 style="margin: 0;">EU Declaration of Conformity</h2> <p style="margin: 0; font-size: small;">In the meaning of the directive 2014/34/EU Annex X, 2014/30/EU Annex II, 2009/125/EG Annex IV and 2011/65/EU Annex VI</p>																											
<p>Getriebebau NORD GmbH &amp; Co. KG as manufacturer in sole responsibility hereby declares, <span style="float: right;">Page 1 of 1</span>          that the variable speed drives from the product series NORDAC BASE</p> <ul style="list-style-type: none"> <li>• SK 180E-xxx-123-B-., SK 180E-xxx-323-B-., SK 180E-xxx-340-B-.</li> <li>• SK 190E-xxx-123-B-., SK 190E-xxx-323-B-., SK 190E-xxx-340-B-.</li> </ul> <p style="font-size: small;">(xxx= 250, 370, 550, 750, 111, 151, 221)</p> <p>and the further options/accessories:          SK CU4-PBR, SK CU4-CAO, SK CU4-DEV, SK CU4-PNT, SK CU4-ECT, SK CU4-POL, SK CU4-EIP, SK CU4-IOE,          SK ATX-POT, SK BRI4-1-200-100, SK BRI4-1-400-100, SK TIE4-WMK-1, SK TIE4-M12-M16</p> <p>with ATEX labeling </p> <p>comply with the following regulations:</p> <table style="width: 100%; font-size: small;"> <tr> <td><b>ATEX Directive for products</b></td> <td><b>2014/34/EU</b></td> <td>OJ. L 96 of 29.3.2014, p. 309–356</td> </tr> <tr> <td><b>EMC Directive</b></td> <td><b>2014/30/EU</b></td> <td>OJ. L 96 of 29.3.2014, p. 79–106</td> </tr> <tr> <td><b>Ecodesign Directive</b></td> <td><b>2009/125/EG</b></td> <td>OJ. L 285 of 31.10.2009, p. 10–35</td> </tr> <tr> <td><b>Regulation (EU) Ecodesign</b></td> <td><b>2019/1781</b></td> <td>OJ. L 272 of 25.10.2019, p. 74–94</td> </tr> <tr> <td><b>RoHS Directive</b></td> <td><b>2011/65/EU</b></td> <td>OJ. L 174 of 1.7.2011, p. 88–11</td> </tr> <tr> <td><b>Delegated Directive (EU)</b></td> <td><b>2015/863</b></td> <td>OJ. L 137 of 4.6.2015, p. 10–12</td> </tr> </table> <p><b>Applied standards:</b></p> <table style="width: 100%; font-size: small;"> <tr> <td>EN 60079-0:2018</td> <td>EN 60079-31:2014</td> <td>EN 61800-9-1:2017</td> </tr> <tr> <td>EN 61800-5-1:2007+A1:2017</td> <td>EN 61800-3:2018</td> <td>EN 61800-9-2:2017</td> </tr> <tr> <td>EN 60529:1991+A1:2000+A2:2013+AC:2016</td> <td>EN 63000:2018</td> <td></td> </tr> </table> <p>It is necessary to notice the data in the operating manual to meet the regulations of the EMC-Directive.          Specially take care about correct EMC installation and cabling, differences in the field of applications and if necessary original accessories.</p> <p>First marking was carried out in 2015.</p> <p><b>Bargteheide, 17.03.2021</b></p> <div style="display: flex; justify-content: space-around; margin-top: 20px;"> <div style="text-align: center;">  <p>U. Küchenmeister Managing Director</p> </div> <div style="text-align: center;">  <p>pp F. Wiedemann Head of Inverter Division</p> </div> </div>	<b>ATEX Directive for products</b>	<b>2014/34/EU</b>	OJ. L 96 of 29.3.2014, p. 309–356	<b>EMC Directive</b>	<b>2014/30/EU</b>	OJ. L 96 of 29.3.2014, p. 79–106	<b>Ecodesign Directive</b>	<b>2009/125/EG</b>	OJ. L 285 of 31.10.2009, p. 10–35	<b>Regulation (EU) Ecodesign</b>	<b>2019/1781</b>	OJ. L 272 of 25.10.2019, p. 74–94	<b>RoHS Directive</b>	<b>2011/65/EU</b>	OJ. L 174 of 1.7.2011, p. 88–11	<b>Delegated Directive (EU)</b>	<b>2015/863</b>	OJ. L 137 of 4.6.2015, p. 10–12	EN 60079-0:2018	EN 60079-31:2014	EN 61800-9-1:2017	EN 61800-5-1:2007+A1:2017	EN 61800-3:2018	EN 61800-9-2:2017	EN 60529:1991+A1:2000+A2:2013+AC:2016	EN 63000:2018	
<b>ATEX Directive for products</b>	<b>2014/34/EU</b>	OJ. L 96 of 29.3.2014, p. 309–356																									
<b>EMC Directive</b>	<b>2014/30/EU</b>	OJ. L 96 of 29.3.2014, p. 79–106																									
<b>Ecodesign Directive</b>	<b>2009/125/EG</b>	OJ. L 285 of 31.10.2009, p. 10–35																									
<b>Regulation (EU) Ecodesign</b>	<b>2019/1781</b>	OJ. L 272 of 25.10.2019, p. 74–94																									
<b>RoHS Directive</b>	<b>2011/65/EU</b>	OJ. L 174 of 1.7.2011, p. 88–11																									
<b>Delegated Directive (EU)</b>	<b>2015/863</b>	OJ. L 137 of 4.6.2015, p. 10–12																									
EN 60079-0:2018	EN 60079-31:2014	EN 61800-9-1:2017																									
EN 61800-5-1:2007+A1:2017	EN 61800-3:2018	EN 61800-9-2:2017																									
EN 60529:1991+A1:2000+A2:2013+AC:2016	EN 63000:2018																										

## 2.5.2 Operation in potentially explosive environments - EAC Ex

ATTENTION! EAC Ex devices are no longer available after July, 01th 2023!

All of the conditions which must be observed for operation of the frequency inverter in an explosion hazard environment according to EAC Ex are listed below. All of the conditions according to

Section 2.5.1 "Operation in potentially explosive environments - ATEX zone 22 3D "apply . Deviations which are relevant for approval according to EAC EX are described below and must be complied with.

### 2.5.2.1 Modification of the device

Section 2.5.1.1 "Modification of the device for compliance with category 3D"applies.

The labelling of the device according to EAC Ex differs as follows.

#### Labelling of the device:



The following applies for wall mounted devices;

IP55: Ex tc IIIB T125 °C Dc X

IP66: Ex tc IIIC T125 °C Dc X



The following applies for motor mounted devices;

IP55: Ex tc IIIB Dc U

IP66: Ex tc IIIC Dc U

#### Categorisation:

- Protection with "housing"
- Procedure "A" Zone "22" Category 3D
- Protection class IP55 / IP66 (depending on the device)
  - IP66 is required for conductive dust
- Maximum surface temperature 125 °C
- Ambient temperature -20 °C to +40 °C

#### **i** Information

#### Code "U"

Code "U" applies for frequency inverters which are intended for motor mounting. Devices which are so labelled are considered to be incomplete and may only be operated in combination with a corresponding motor. If a device which is coded "U" is mounted in a motor, the labels and restrictions which are marked on the motor or the geared motor also apply.

#### **i** Information

#### Code "X"

The code "X" indicates that the permissible ambient temperature range is between -20°C and +40°C

**2.5.2.2 Further Information**

Further information regarding explosion protection can be found in the following sections.

Description	Section
"Options for ATEX Zone 22, category 3D"	2.5.1.2
"Maximum output voltage and torque reduction"	2.5.1.3
"Commissioning information"	2.5.1.4

**2.5.2.3 EAC Ex certificate**

[TC RU C-DE.AA87.B.01109](#)

## 2.6 Outdoor installation

The device and the technology units (SK TU4-...) can be installed outdoors under the following conditions:

- IP66 design (with UV-resistant blind plugs, see special measures, Section 1.9 "Version in protection class IP55, IP66, IP69K"),
- Anodised oil inspection glasses (part number: 201114000), quantity: 1,
- Cover device to ensure protection against direct meteorological effects (rain/sun),
- Accessories used (e.g. plug connectors), also at least IP66.

## 3 Display, operation and options



### WARNING

### Electric shock

When devices are open, electrically conducting elements (e.g. connection terminals, connection cables, PCBs, etc.) are freely accessible. These may be live, even if the device has been switched off.

- Avoid all contact.

As supplied, without additional options, the diagnostic LED is externally visible. This indicates the actual status of the device. In contrast, the AS-i LED (SK 190E) is only visible if the device is open.

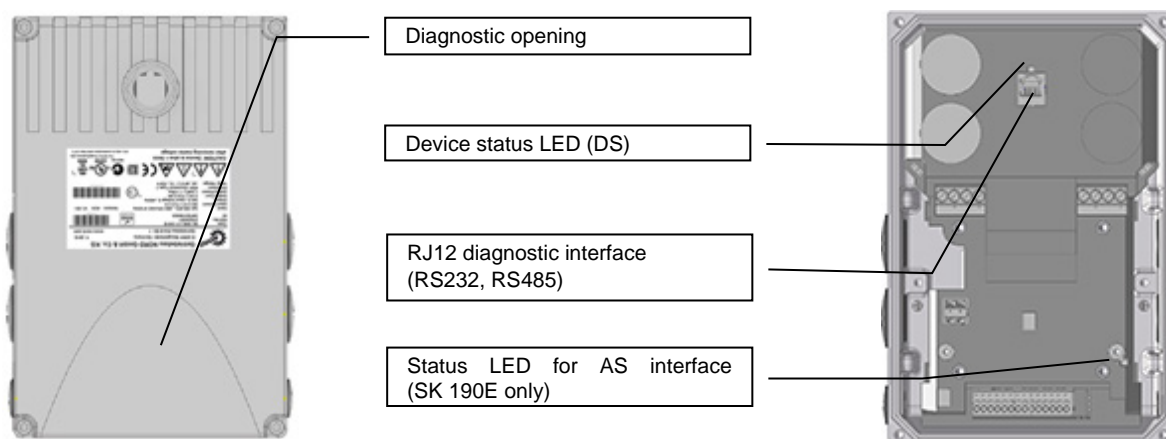

The device can be easily adapted to various requirements by using function-extending modules and modules for for display, control and parameterisation.

Alphanumeric display and control modules (📖 Section 3.1 "Control and parametrisation options ") can be used for simple commissioning by means of adapting parameters. For more complex tasks, connection to a PC system can take place with the aid of the NORDCON parameterisation software.

### 3.1 Control and parametrisation options

Various control options are available that can be fitted directly to the device or in close proximity to it and directly connected.

Parametrisation units also provide a facility for accessing the parametrisation of the device and adapting it.

Designation		Part Number	Document
<b>Switches and potentiometers</b> (attachment)			
SK CU4-POT	Switch/Potentiometer	275271207	📖 Section 3.2.4 "Potentiometer adapter, SK CU4-POT"
SK TIE4-POT	Potentiometer 0-10V	275274700	<a href="#">TI 275274700</a>
SK TIE4-SWT	Switch "L-OFF-R"	275274701	<a href="#">TI 275274701</a>
<b>Control and parametrisation boxes</b> (Handheld)			
SK CSX-3H	SimpleBox	275281013	<a href="#">BU0040</a>
SK PAR-3H	ParameterBox	275281014	<a href="#">BU0040</a>

### 3.1.1 Control and parameterisation units, use

With an optional SimpleBox or ParameterBox all parameters can be conveniently accessed, read out or adjusted. The changed parameter data are stored in the non-volatile EEPROM memory.

Up to five complete device data sets can be stored and accessed in the ParameterBox.

SimpleBox or ParameterBox can be connected to the device via an RJ12-RJ12 cable.



Figure 8: SimpleBox, handheld, SK CSX-3H



Figure 9: ParameterBox, handheld, SK PAR-3H

Module	Description	Data
SK CSX-3H (SimpleBox handheld)	Used for commissioning, parameterisation, configuration and control of the device <sup>1)</sup> .	<ul style="list-style-type: none"> <li>4-digit 7-segment LED display, membrane button</li> <li>IP20</li> <li>RJ12-RJ12 cable (connection to the device <sup>1)</sup>)</li> </ul>
SK PAR-3H (ParameterBox handheld)	Used for commissioning, parameterisation, configuration and control of the device and its options (SK xU4-...). Complete data sets can be stored.	<ul style="list-style-type: none"> <li>4-line LCD display, backlight, membrane button</li> <li>Stores up to five complete parameter data sets</li> <li>IP20</li> <li>RJ12-RJ12 cable (connection to the device)</li> <li>USB cable (connection to PC)</li> </ul>
1) Does not apply for option modules, e.g. bus interfaces		

### Connection

1. Remove the diagnostics glass of the RJ12 socket.
2. Establish RJ12-RJ12 cable connection between control unit and Frequency Inverter.

*As long as a diagnostics glass or a blind plug is open, make sure that no dirt or moisture enters the device.*

3. After commissioning for regular operation, **reinsert all diagnostics glasses or blind plugs** and pay attention to **sealing**.





#### **i** Information

##### Diagnostic caps' tightening torques

The tightening torque for the transparent diagnostic caps (inspection glasses) is 2.5 Nm.

#### 3.1.2 Connection of multiple devices to one parametrisation tool

In principle it is possible to access several frequency inverters via the **ParameterBox** or the **NORDCON software**. In the following example, communication is made via the parameterisation tool, by tunnelling the protocols of the individual devices (max. 4) via the common system bus (CAN). The following points must be noted:

1. Physical bus structure

Establish a CAN connection (system bus) between the devices

2. Parameterisation

Parameter		Settings on the inverter							
No.	Designation	FI 1	FI 2	FI 3	FI 4				
P503	Leading function output	2 (system bus active)							
P512	USS address	0	0	0	0				
P513	Telegram time-out (s)	0.6	0.6	0.6	0.6				
P514	CAN bus baud rate	5 (250 kBaud)							
P515	CAN bus address	32	34	36	38				

3. Connect the parameterisation tool as usual via RS485 (e.g. via RJ12) to the **first** frequency inverter.

*Conditions / Restrictions:*

Basically, all of the currently available frequency converters from NORD can communicate via a common system bus. When devices in the SK 5xxE model series are incorporated, the framework conditions described in the manual for the device series concerned must be noted.

## 3.2 Optional modules

### 3.2.1 Internal customer interfaces SK CU4-... (installation of modules)

Internal customer units allow the scope of functionality of the devices to be extended without changing the physical size thereof. The device provides an installation location for the installing an appropriate option. If other option modules are required the external technology units must be used for these (📖 Section 3.2.2 "External technology units SK TU4-... (module attachment)").



Figure 10: internal customer units SK CU4 ... example

The bus interfaces require an external 24 V power supply, and are therefore also ready for operation if the device is not connected to the mains supply. Parameterisation and diagnosis of the bus interface is therefore possible independently from the frequency inverter.

Designation *)		Part Number	Document
<b>Bus interfaces</b>			
SK CU4-CAO(-C)	CANopen	275271001 / (275271501)	<a href="#">TI 275271001</a> / <a href="#">(TI 275271501)</a>
SK CU4-DEV(-C)	DeviceNet	275271002 / (275271502)	<a href="#">TI 275271002</a> / <a href="#">(TI 275271502)</a>
SK CU4-ECT(-C)	EtherCAT	275271017 / (275271517)	<a href="#">TI 275271017</a> / <a href="#">(TI 275271517)</a>
SK CU4-EIP(-C)	Ethernet IP	275271019 / (275271519)	<a href="#">TI 275271019</a> / <a href="#">(TI 275274519)</a>
SK CU4-PBR(-C)	PROFIBUS DP	275271000 / (275271500)	<a href="#">TI 275271000</a> / <a href="#">(TI 275271500)</a>
SK CU4-PNT(-C)	PROFINET IO	275271015 / (275271515)	<a href="#">TI 275271015</a> / <a href="#">(TI 275271515)</a>
SK CU4-POL(-C)	POWERLINK	275271018 / (275271518)	<a href="#">TI 275271018</a> / <a href="#">(TI 275271518)</a>
<b>IO -Extensions</b>			
SK CU4-IOE(-C)		275271006 / (275271506)	<a href="#">TI 275271006</a> / <a href="#">TI 275271506</a>
SK CU4-IOE2(-C)		275271007 / (275271507)	<a href="#">TI 275271007</a> / <a href="#">TI 275271507</a>
SK CU4-REL(-C)		275271011 / (275271511)	<a href="#">TI 275271011</a> / <a href="#">TI 275271511</a>
<b>Power supply</b>			
SK CU4-24V-123-B(-C)		275271108 / (275271608)	<a href="#">TI 275271108</a> / <a href="#">TI 275271608</a>
SK CU4-24V-140-B(-C)		275271109 / (275271609)	<a href="#">TI 275271109</a> / <a href="#">TI 275271609</a>
<b>Miscellaneous</b>			
SK CU4-FUSE(-C)	Fuse module	275271122 / (275271622)	<a href="#">TI 275271122</a> / <a href="#">TI 275271622</a>
SK CU4-MBR(-C)	El. brake rectifier	275271010 / (275271510)	<a href="#">TI 275271010</a> / <a href="#">TI 275271510</a>

\*) All modules with the identifier **-C** have lacquered PCBs so that they can be used in IP6x devices.

#### 3.2.2 External technology units SK TU4-... (module attachment)

External technology units allow the scope of functionality of the devices to be extended in a modular way.

Depending on the type of module, different versions are available (differentiated according to IP protection class, with/without connector etc.). They can be fitted directly to the device using the relevant connection unit or in the vicinity of the device using an optional wall mounting kit.

**Each SK TU4-... technology unit requires an associated SK T14-TU-... connection unit.**



Figure 11: external technology units SK TU4-... (example)

With the bus modules or the I/O extension, it is possible to access the system bus via the RJ12 socket (behind a transparent screw gland (diagnostics glass)) and therefore access all active devices that are connected to it (frequency inverters, other SK xU4 modules) using ParameterBox SK PAR-3H or a PC (NORDCON software).

The bus modules require a 24 V power supply. If the power is on the bus modules are ready, even if the frequency inverter is not in operation.

Type	IP55	IP66	M12	Designation	Part Number	Document
CANopen	X			SK TU4-CAO	275 281 101	<a href="#">TI 275281101</a>
		X		SK TU4-CAO-C	275 281 151	<a href="#">TI 275281151</a>
	X		X	SK TU4-CAO-M12	275 281 201	<a href="#">TI 275281201</a>
		X	X	SK TU4-CAO-M12-C	275 281 251	<a href="#">TI 275281251</a>
DeviceNet	X			SK TU4-DEV	275 281 102	<a href="#">TI 275281102</a>
		X		SK TU4-DEV-C	275 281 152	<a href="#">TI 275281152</a>
	X		X	SK TU4-DEV-M12	275 281 202	<a href="#">TI 275281202</a>
		X	X	SK TU4-DEV-M12-C	275 281 252	<a href="#">TI 275281101</a>
EtherCAT	X			SK TU4-ECT	275 281 117	<a href="#">TI 275281117</a>
		X		SK TU4-ECT-C	275 281 167	<a href="#">TI 275281167</a>
EtherNet/IP	X		X	SK TU4-EIP	275 281 119	<a href="#">TI 275281119</a>
		X	X	SK TU4-EIP-C	275 281 169	<a href="#">TI 275281169</a>
POWERLINK	X			SK TU4-POL	275 281 118	<a href="#">TI 275281118</a>
		X		SK TU4-POL-C	275 281 168	<a href="#">TI 275281168</a>
PROFIBUS DP	X			SK TU4-PBR	275 281 100	<a href="#">TI 275281100</a>
		X		SK TU4-PBR-C	275 281 150	<a href="#">TI 275281150</a>
	X		X	SK TU4-PBR-M12	275 281 200	<a href="#">TI 275281200</a>
		X	X	SK TU4-PBR-M12-C	275 281 250	<a href="#">TI 275281250</a>
PROFINET IO	X			SK TU4-PNT	275 281 115	<a href="#">TI 275281115</a>

Type	IP55	IP66	M12	Designation	Part Number	Document
		X		SK TU4-PNT-C	275 281 165	<a href="#">TI 275281165</a>
	X		X	SK TU4-PNT-M12	275 281 122	<a href="#">TI 275281122</a>
		X	X	SK TU4-PNT-M12-C	275 281 172	<a href="#">TI 275281172</a>
I/O extension	X			SK TU4-IOE	275 281 106	<a href="#">TI 275281106</a>
		X		SK TU4-IOE-C	275 281 156	<a href="#">TI 275281156</a>
	X		X	SK TU4-IOE-M12	275 281 206	<a href="#">TI 275281206</a>
		X	X	SK TU4-IOE-M12-C	275 281 256	<a href="#">TI 275281256</a>
<b>Required accessories (each module must have a matching connection unit)</b>						
Connection unit	X			SK TI4-TU-BUS	275 280 000	<a href="#">TI 275280000</a>
		X		SK TI4-TU-BUS-C	275 280 500	<a href="#">TI 275280500</a>
<b>Optional accessories</b>						
Wall-mounting kit	X	X		SK TIE4-WMK-TU	275 274 002	<a href="#">TI 275274002</a>

Table 7: external bus modules and IO expansions SK TU4- ...

Type	IP55	IP66	Designation	Part Number	Document
Power supply 24V / 1~ 230V	X		SK TU4-24V-123-B	275 281 108	<a href="#">TI 275281108</a>
		X	SK TU4-24V-123-B-C	275 281 158	<a href="#">TI 275281158</a>
Power supply 24V / 1~ 400V	X		SK TU4-24V-140-B	275 281 109	<a href="#">TI 275281109</a>
		X	SK TU4-24V-140-B-C	275 281 159	<a href="#">TI 275281159</a>
PotentiometerBox 1~ 230V	X		SK TU4-POT-123-B	275 281 110	<a href="#">TI 275281110</a>
		X	SK TU4-POT-123-B-C	275 281 160	<a href="#">TI 275281160</a>
PotentiometerBox 1~ 400V	X		SK TU4-POT-140-B	275 281 111	<a href="#">TI 275281111</a>
		X	SK TU4-POT-140-B-C	275 281 161	<a href="#">TI 275281161</a>
<b>Required accessories (each module must have an associated connection unit)</b>					
Connection unit	X		SK TI4-TU-NET	275 280 100	<a href="#">TI 275280100</a>
		X	SK TI4-TU-NET-C	275 280 600	<a href="#">TI 275280600</a>
<b>Optional accessories</b>					
Wall-mounting kit	X	X	SK TIE4-WMK-TU	275 274 002	<a href="#">TI 275274002</a>

Table 8: external modules with power supply SK TU4-24V- ... / SK TU4-POT- ...

Type	IP55	IP66	Designation	Part Number	Document
Maintenance switch	X		SK TU4-MSW	275 281 123	<a href="#">TI 275281123</a>
		X	SK TU4-MSW-C	275 281 173	<a href="#">TI 275281173</a>
	X		SK TU4-MSW-RG	275 281 125	<a href="#">TI 275281125</a>
		X	SK TU4-MSW-RG-C	275 281 175	<a href="#">TI 275281175</a>
<b>Required accessories (each module must have a matching connection unit)</b>					
Connection unit	X		SK TI4-TU-MSW	275 280 200	<a href="#">TI 275280200</a>
		X	SK TI4-TU-MSW-C	275 280 700	<a href="#">TI 275280700</a>
<b>Optional accessories</b>					
Wall-mounting kit	X	X	SK TIE4-WMK-TU	275 274 002	<a href="#">TI 275274002</a>

Table 9: external modules – maintenance switch SK TU4-MSW- ...

#### 3.2.3 plug connectors

The use of optionally available plug connectors for power and control connections not only makes it possible to replace the drive unit with almost no loss of time in case of servicing, but also minimises the danger of installation errors when connecting the device. The most common plug connector versions are summarised below. The possible installation locations on the device are listed in section 2.2 "Installation of optional modules".

##### 3.2.3.1 Plug connectors for power connections

Various connectors are available for the motor or mains connection.

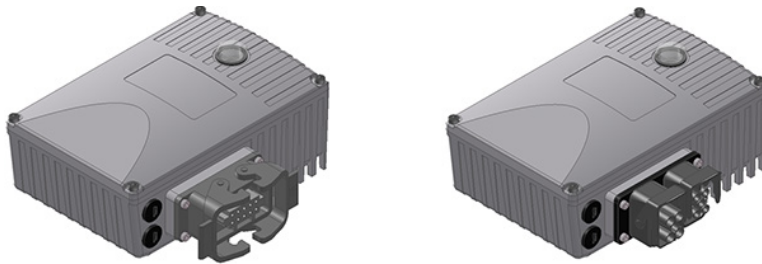

Figure 12: Examples of devices with connectors for connecting the power

3 different connections are available, which can also be combined (example "-LE-MA"):

Mounting version	Meaning
... - LE	Power input
... - LA	Power output
... - MA	Motor output

**Connector (selection)**

Type	Data	Designation	Material no.	Document
Power input	500 V, 16 A	SK TIE4-HANQ8-K-LE-MX	275 135 030	<a href="#">TI 275135030</a>
Power input	500 V, 16 A	SK TIE4-HAN10E-M1B-LE	275 135 070	<a href="#">TI 275135070</a>
Power input	500 V, 16 A	SK TIE4-HAN10E-M2B-LE	275 135 000	<a href="#">TI 275135000</a>
Power input	690 V, 20 A	SK TIE4-QPD_3PE-K-LE	275 274 125	<a href="#">TI 275274125</a>
Power input	630 V, 16 A	SK TIE4-NQ16-K-LE	275 274 133	<a href="#">TI 275274133</a>
Power input + power outlet	400 V, 16 A	SK TIE4-2HANQ5-K-LE-LA	275 274 110	<a href="#">TI 275274110</a>
Power input + motor outlet	600 V, 16 A	SK TIE4-2HANQ5-M-LE-MA-001	275 274 123	<a href="#">TI 275274123</a>
Power output	500 V, 16 A	SK TIE4-HAN10E-M2B-LA	275 135 010	<a href="#">TI 275135010</a>
Power output	500 V, 16 A	SK TIE4-HANQ8-K-LA-MX	275 135 040	<a href="#">TI 275135040</a>
Motor output	500 V, 16 A	SK TIE4-HAN10E-M2B-MA	275 135 020	<a href="#">TI 275135020</a>
Motor output	500 V, 16 A	SK TIE4-HANQ8-K-MA-MX	275 135 050	<a href="#">TI 275135050</a>

**i Information**

**Looping of the mains voltage**

The permissible current load for the connection terminals, plugs and supply cables must be observed when looping the mains voltage. Failure to comply with this will result in thermal damage to current-carrying modules and the immediate vicinity thereof.

**3.2.3.2 Plug connectors for control connection**

Various M12 round plug connectors are available as flanged plugs or flanged sockets. The plug connectors are intended for installation in an M16 cable gland of the device, or in an external technology unit. The protection class (IP67) of the plug connector only applies in the screwed state. Similarly to the use of coding pins / grooves, the colour coding of the connectors (plastic unit inside and cover caps) is based on functional requirements and is intended to avoid erroneous operation.

Suitable expansion and reducer adapters are available for installation in M12 and M20 cable glands.

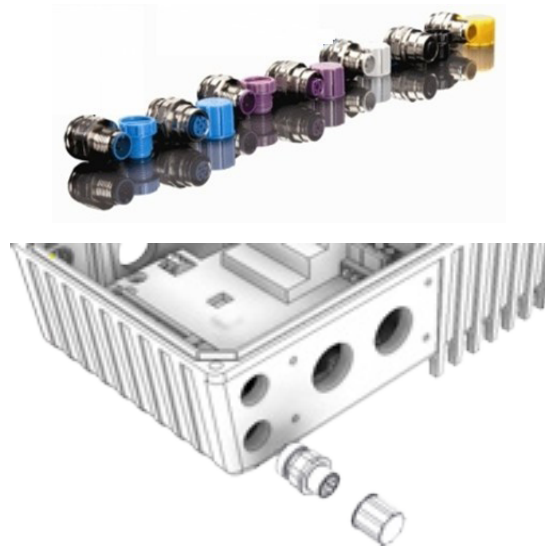

**i Information**

**Control unit overload**

The control unit of the device can be overloaded and destroyed if the 24 V DC supply terminals of the device are connected to another voltage source

For this reason, particularly when installing connectors for the control connection it must be ensured that any cores for the 24 V DC power supply are not connected to the device but are insulated accordingly (example of connector for system bus connection SK TIE4-M12-SYSS).

#### Connector (selection)

Type	Version	Designation	Part Number	Document
Power supply	Connector	SK TIE4-M12-POW	275 274 507	<a href="#">TI 275274507</a>
Sensors / actuators	Socket	SK TIE4-M12-INI	275 274 503	<a href="#">TI 275274503</a>
Initiators and 24 V	Connector	SK TIE4-M12-CAO	275 274 516	<a href="#">TI 275274516</a>
AS Interface	Connector	SK TIE4-M12-ASI	275 274 502	<a href="#">TI 275274502</a>
PROFIBUS ( <i>IN</i> + <i>OUT</i> )	Plug connector + socket	SK TIE4-M12-PBR	275 274 500	<a href="#">TI 275274500</a>
Analogue signal	Socket	SK TIE4-M12-ANA	275 274 508	<a href="#">TI 275274508</a>
CANopen or DeviceNet <i>IN</i>	Connector	SK TIE4-M12-CAO	275 274 501	<a href="#">TI 275274501</a>
CANopen or DeviceNet <i>OUT</i>	Socket	SK TIE4-M12-CAO-OUT	275 274 515	<a href="#">TI 275274515</a>
Ethernet	Socket	SK TIE4-M12-ETH	275 274 514	<a href="#">TI 275274514</a>
System bus <i>IN</i>	Connector	SK TIE4-M12-SYSS	275 274 506	<a href="#">TI 275274506</a>
System bus <i>OUT</i>	Socket	SK TIE4-M12-SYSM	275 274 505	<a href="#">TI 275274505</a>

### 3.2.4 Potentiometer adapter, SK CU4-POT

Part no.: 275 271 207

The digital signals R and L can be directly applied to the frequency inverter’s digital inputs 1 and 2.

The potentiometer (0 - 10 V) can be evaluated via an analogue input from the frequency inverter or from an I/O extension.



Module		SK CU4-POT (Part no.: 275 271 207)	Connection: Terminal no.			Function
Pin	Colour		SK 1x0E			
			FI			
1	Brown	24 V supply voltage	43			Rotary switch L - OFF - R
2	Black	Enable R (e.g. DIN1)	21			
3	White	Enable L (e.g. DIN2)	22			
4	White	Tap on AIN1+	14			Potentiometer 10 kΩ
5	Brown	Reference voltage 10 V	11			
6	Blue	Analogue ground AGND	12			

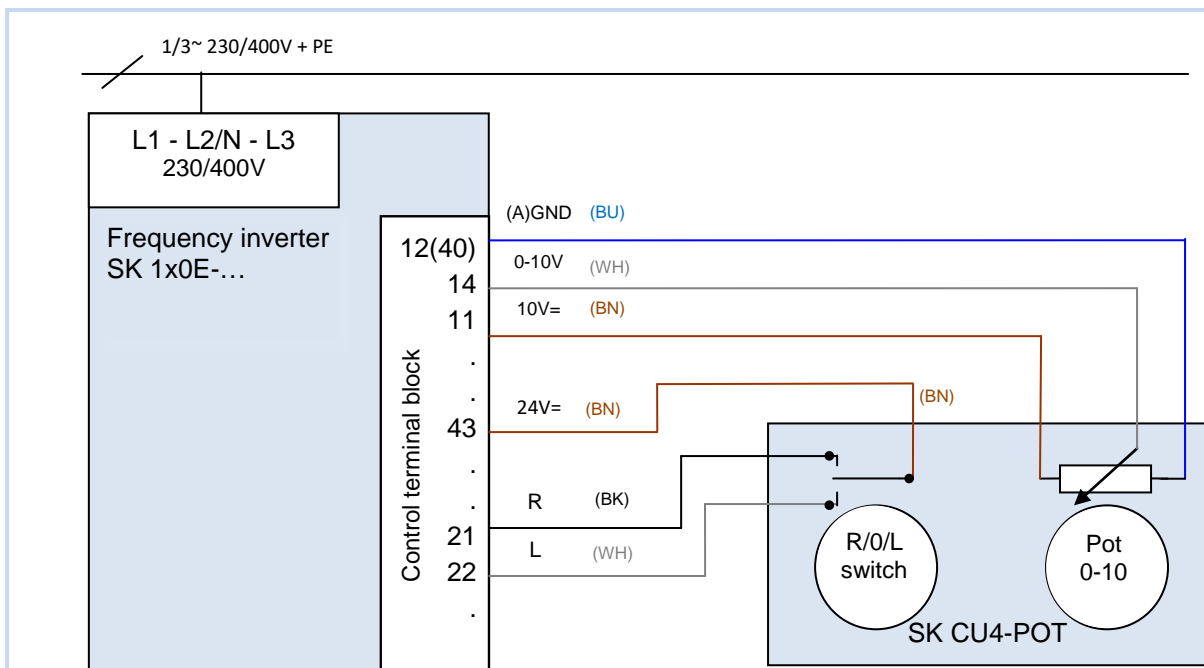

Figure 13: Wiring diagram SK CU4-POT, example SK 1x0E



### 4 Commissioning

#### WARNING

##### Unexpected movement

Connection of the supply voltage may directly or indirectly set the drive unit into motion. This can cause unexpected movement of the drive and the attached machine, which may result in serious or fatal injuries and/or material damage. Possible causes of unexpected movements are e.g.:

- Parameterisation of an "automatic start"
  - Incorrect parameterisation
  - Control of the device with an enabling signal from a higher level control unit (via IO or bus signals)
  - Incorrect motor data
  - Incorrect encoder connection
  - Release of a mechanical holding brake
  - External influences such as gravity or other kinetic energy which acts on the drive unit
  - In IT networks: Earth fault (short circuit to earth)
- To avoid any resulting hazard the drive or drive chain must be secured against unexpected movements (mechanical blocking and/or decoupling, provision of protection against falling, etc.) In addition, it must be ensured that there are no persons within the area of action and the danger area of the system.

#### 4.1 Factory settings

All frequency inverters supplied by Getriebebau NORD are pre-programmed with the default setting for standard applications with 4 pole standard motors (same voltage and power). For use with motors with other powers or number of poles, the data from the rating plate of the motor must be input into the parameters **P201...P207** under the menu item >Motor data<.

All motor data (IE1, IE4) can be pre-set using parameter **P200**. After use of this function, this parameter is reset to 0 = no change! The data is loaded automatically into parameters **P201...P209** – and can be compared again with the data on the motor rating plate.

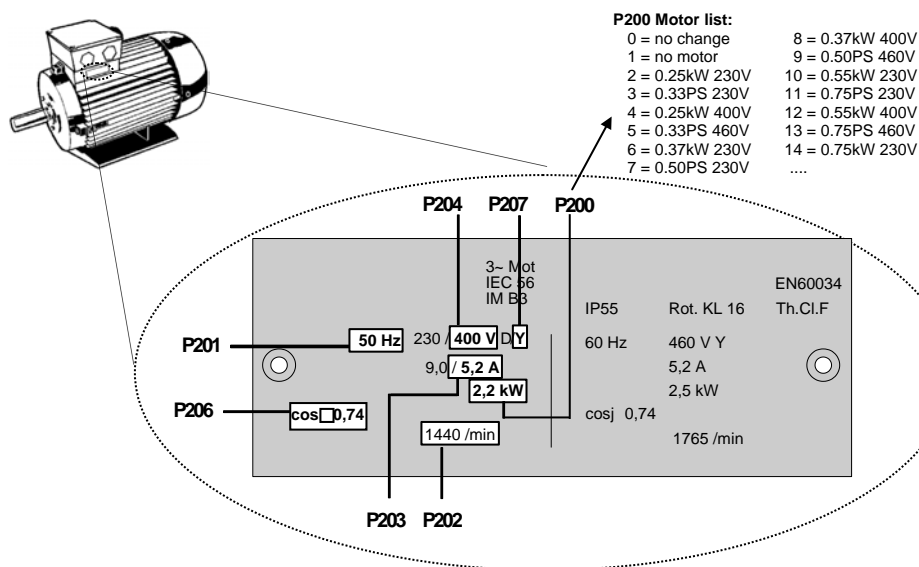

For the correct operation of the drive unit, it is necessary to input the motor data (rating plate) as precisely as possible. In particular, an automatic stator resistance measurement using parameter **P220** is recommended.

## 4.2 Selecting the operating mode for motor control

The frequency inverter is able to control motors with all efficiency classes (IE1 to IE4). Motors which we manufacture are produced as asynchronous motors in efficiency classes IE1 to IE3, whereas IE4 motors are produced as synchronous motors.

Operation of IE4 motors has many special features with regard to the control technology. In order to enable the optimum results, the frequency inverter was specially designed for the control of NORD IE4 motors, whose construction corresponds to an IPMSM type (Interior Permanent Magnet Synchronous Motor). In these motors, the permanent magnets are embedded in the rotor. The operation of other brands must be checked by NORD as necessary. Also refer to the technical information [TI 80-0010](#) "Planning and commissioning guidelines for NORD IE4 motors with NORD frequency inverters".

### 4.2.1 Explanation of the operating modes (P300)

The frequency inverter provides different operating modes for the control of a motor. All operating modes can be used with either an ASM (asynchronous motor) or a PMSM (Permanent Magnet Synchronous Motor), however various constraints must be complied with. In principle, all these methods are "flux oriented control methods".

#### 1. VFC open-loop mode (P300, setting "0")

This operating mode is based on a voltage-governed flux oriented control method (Voltage Flux Control Mode (VFC)). This is used for both ASMs as well as PMSMs. In association with the operation of asynchronous motors this is often referred to as "ISD control".

Control is carried out without the use of encoders and exclusively on the basis of fixed parameters and the measurement results of actual electrical values. No specific control parameter settings are necessary for the use of this mode. However, parameterisation of the precise motor data is an essential prerequisite for efficient operation.

As a special feature for the operation of an ASM there is also the possibility of control according to a simple V/f characteristic curve. This mode of operation is important if several motors which are not mechanically coupled are to be operated with a single frequency inverter, or if it is only possible to determine the motor data in a comparatively imprecise manner.

Operation according to a V/f characteristic curve is only suitable for drive applications with relatively low demands on the quality of speed control and dynamics (ramp times  $\geq 1$  s). For machines which tend to have relatively large mechanical vibrations due to their construction, control according to a V/f characteristic curve can also be advisable. Typically, V/f characteristic curves are used to control fans, certain types of pump drives or agitators. Operation according to a V/f characteristic curve is activated via parameters (P211) and (P212) (each set to "0").

### 4.2.2 Overview of control parameter settings

The following provides an overview of all parameters which are of importance, depending on the selected operating mode. Among other things, a distinction is made between "relevant" and "important", which provides an indication of the required precision of the particular parameter setting. However, in principle, the more precisely the setting is made, the more exact the control, so that higher values for dynamics and precision are possible for the operation of the drive unit. A detailed description of these parameters can be found in Section 5 "Parameter".

"Ø" =	Parameter has no significance	"-" =	Leave the parameter in the factory setting
"√" =	Setting of the parameter is relevant	"!" =	Setting of the parameter is important

Group	Parameter	Operating mode					
		VFC open-loop		CFC open-loop			
		ASMs	PMSMs	ASMs	PMSMs		
Motor data	P201 ... P209	√	√	√	√		
	P208	!	!	!	!		
	P210	√ <sup>1)</sup>	√	√	√		
	P211, P212	- <sup>2)</sup>	-	-	-		
	P215, P216	- <sup>1)</sup>	-	-	-		
	P217	√	√	√	√		
	P220	√	√	√	√		
	P240	-	√	-	√		
	P241	-	√	-	√		
	P243	-	√	-	√		
	P244	-	√	-	√		
	P246	-	√	-	√		
	P245, 247	-	√	∅	∅		
Controller data	P300	√	√	√	√		
	P301	∅	∅	∅	∅		
	P310 ... P320	∅	∅	√	√		
	P312, P313, P315, P316	∅	∅	-	√		
	P330 ... P333	-	√	-	√		
	P334	∅	∅	∅	∅		

<sup>1)</sup> = For V/f characteristic curve: precise matching of the parameter is important.  
<sup>2)</sup> = For V/f characteristic curves: typical setting "0"

### 4.2.3 Motor control commissioning steps

The main commissioning steps are mentioned below in their ideal order. Correct assignment of the inverter / motor and the mains voltage is assumed. Detailed information, especially for optimisation of the current, speed and position control of asynchronous motors is described in the guide "Control optimisation" (AG 0100). Please contact our Technical Support.

1. Make the motor connection as usual (note  $\Delta$  / Y!)
2. Connect the mains supply.
3. Carry out the factory setting (P523)
4. Select the basic motor from the motor list (P200) (ASM types are at the beginning of the list, PMSM types are at the end, designated by their type (e.g. ...80T...))
5. Check the motor data (P201 ... P209) and compare with the type plate / motor data sheet
6. Measure the stator resistance (P220) → P208, P241[-01] are measured, P241[-02] is calculated. (Note: if an SPMSM is used, P241[-02] must be overwritten with the value from P241[-01])
7. with PMSM only:
  - a. EMF voltage (P240) → motor type plate / motor data sheet
  - b. Determine / set reluctance angle (P243) (not required with NORD motors)
  - c. Peak current (P244) → motor data sheet
  - d. Only for PMSMs in VFC mode:  
determine (P245), (P247)
  - e. Determine (P246)
8. Select the operating mode (P300)
9. Determine / adjust the current control (P312 – P316)
10. PMSM only:

- a. Select the control method (P330)
- b. Make the settings for the starting behaviour (P331 ... P333)

---

** Information**

**NORD IE4 Motors**

Further information for commissioning NORD IE4 motors with NORD frequency inverters can be found in the technical information [TI80\\_0010](#).

---

### 4.3 Starting up the device

The frequency inverter can be started up by making parameter adjustments using the ControlBox and the ParameterBox (SK CSX-3H or SK PAR-3H) or the NORD CON PC-based software. When doing this, the changes to the parameters are stored in the internal EEPROM.

#### **i** Information

#### Presetting of physical I/O and I/O bits

For commissioning standard applications, a limited number of the frequency inverter inputs and outputs (physical and I/O bits) have predefined functions. These settings may need to be changed (Parameters (P420), (P434), (P480), (P481)).

#### 4.3.1 Connection

In order to provide basic operational capability, after the device has been attached to the motor or the wall mounting kit, the power and motor lines must be connected to the relevant terminals ( Section 2.4.2 "Electrical connection of power unit").

#### 4.3.2 Configuration

Changes to individual parameters are usually necessary for operation.

##### 4.3.2.1 Parameterisation

The use of a ParameterBox (SK CSX-3H / SK PAR) or the NORDCON software is required in order to adapt the parameters.

Parameter group	Parameter numbers	Functions	Comments
Basic parameters	P102 ... P105	Ramp times and frequency limits	
Motor data	P201 ... P207, (P208)	Data on motor rating plate	
	P220, Function 1 alternatively P200	Measure stator resistance Motor data list	Value is written to P208 Selection of a 4-pole standard NORD motor from a list
	alternatively P220, Function 2	Motor identification	Complete measurement of a connected motor Prerequisite: Motor no more than 3 power levels less than the frequency inverter
Control terminals	P400, P420	Analogue and digital inputs	

#### **i** Information

#### Factory settings

Prior to restarting, it should be ensured that the frequency inverter is in its factory settings (P523).

The DIP switches S2 should remain in the "OFF" setting. The DIP switches S2 have priority over parameters P509, P514 and P515.

### 4.3.2.2 DIP switches (S1, S2)

The analogue inputs in the device are suitable for current and voltage setpoints. For correct processing of current setpoints (0-20 mA / 4-20 mA) the relevant DIP switch (**S1** – bit 2 or 3) must be set to current signals ("ON").

DIP switch (**S1** – bit 1) sets the terminating resistance of the system bus.

The system settings can be made via DIP switch (**S2**). Settings made at DIP switch (S2) have priority over the parameters P509, P514 and P515.

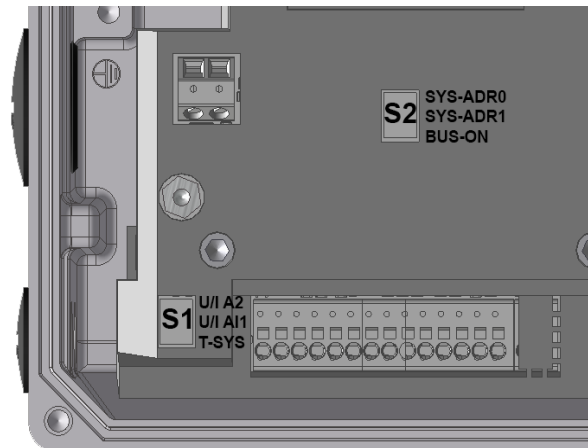

As delivered, all DIP switches are in the "0" ("OFF") position.

#### No.

#### Bit DIP switch (S1)

3	<b>U/I A2</b> <sup>1)</sup> Voltage / current	0	Analogue input 2 in voltage mode 0...10 V
		1	Analogue input 2 in current mode 0/4...20 mA
2	<b>U/I A1</b> <sup>1)</sup> Voltage / current	0	Analogue input 1 in voltage mode 0...10 V
		1	Analogue input 1 in current mode 0/4...20 mA
1	<b>T-SYS</b> Terminating resistance	0	System bus terminating resistance deactivated
		1	System bus terminating resistance activated

1) Adjustment to fail-safe signals in case of cable breaks (2-10 V / 4-20 mA) is made via parameters P402 and P403.

#### No.

#### Bit DIP switch (S2)

3/2 2 <sup>0/1</sup>	<b>SYS-ADR 0/1</b> System bus Address/ baud rate	<b>SYS-ADR</b>		
		1	0	
		0	0	In accordance with P515 and P514 [32, 250kBaud]
		0	1	Address 34, 250 kBaud
		1	0	Address 36, 250 kBaud
1 2 <sup>2</sup>	<b>BUS-ON</b> Control word and setpoint value source	0	In accordance with P509 and P510 [-01, -02]	
		1	System bus (→ P509=3 and P510=3)	

### 4.3.3 Commissioning examples

All SK 1x0E models can be operated as delivered. Standard motor data for a 4-pole standard asynchronous motor of the same power is parameterised. The PTC input must be bypassed, if a motor with PTC is not available. Parameter (P428) must be changed if an automatic startup with "Mains On" is required.

#### Minimal configuration

The frequency inverter provides all the necessary control voltages (24 VDC / 10 VDC).

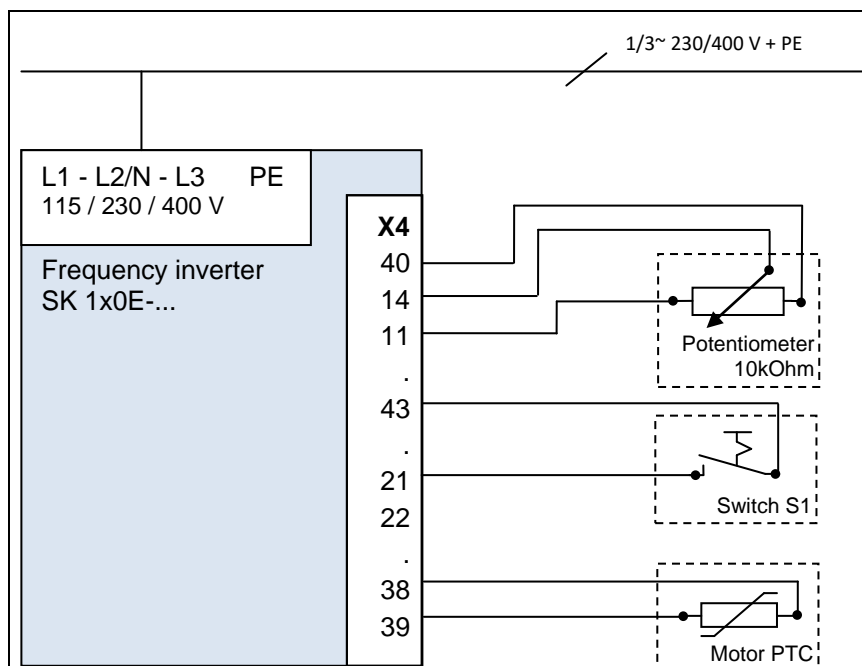

Function	Setting
Setpoint	External 10 kΩ potentiometer
Approval	External switch S1

#### Minimal configuration with options

In order to implement completely autonomous operation (independent of control cables etc.) a switch and a potentiometer such as potentiometer adapter SK CU4-POT is required. In this way, the speed and direction control in accordance with requirements can be achieved with only a single mains cable (single phase or three-phase depending on version) (📖 Section 3.2.4 "Potentiometer adapter, SK CU4-POT"),

## 4.4 Temperature sensors

The current vector control of the frequency inverter can be further optimised by the use of a *temperature sensor*. By continuous measurement of the motor temperature, the highest precision of regulation by the frequency inverter and the associated optimum speed precision of the motor is achieved at all times. As the temperature measurement starts immediately after (mains) switch-on of the frequency inverter, the frequency inverter provides immediate optimum control, even if the motor has a considerably increased in temperature after an intermediate "Mains off / Mains on" of the frequency inverter.

### Information

To determine the stator resistance of the motor, the temperature range 15 ... 25 °C should not be exceeded.

Excess temperature of the motor is also monitored and at 155 °C (switching threshold for the thermistor) causes the drive unit to shut down with error message E002.

### Information

#### Pay attention to polarity

Temperature sensors are wired semiconductors that must be operated in the conducting direction. For this, the anode must be connected to the "+" contact of the analogue input. The cathode must be connected to earth.

Failure to observe this can lead to false measurements. Motor winding protection is therefore no longer guaranteed.

#### Approved temperature sensors

The function of approved temperature sensors is comparable. However, their characteristic curves differ. Correct matching of the characteristic curves to the frequency inverter is made by changing the following two parameters.

Sensor type	Shunt resistor [kΩ]	P402[xx] <sup>1)</sup> 0 % Adjustment [V]	P403[xx] <sup>1)</sup> 100 % Adjustment [V]
KTY84-130	2.7	1.54	2.64
PT100	2.7	0.36	0.49
PT1000	2.7	2.68	3.32
1) Xx = Parameter array, depending on the analog input used			

**Table 10: Temperature sensors, adjustment**

Connection of a temperature sensor is made according to the following examples.

Taking into account the relevant values for the 0% adjustment [P402] and 100% adjustment [P403], these examples can be used for all of the approved temperature sensors which are stated above.



### Connection examples

#### SK CU4-IOE / SK TU4-IOE-...

Connection of a KTY-84 to either of the two analogue inputs of the relevant option is possible. In the following examples, analogue input 2 of the particular optional module is used.

SK CU4-IOE

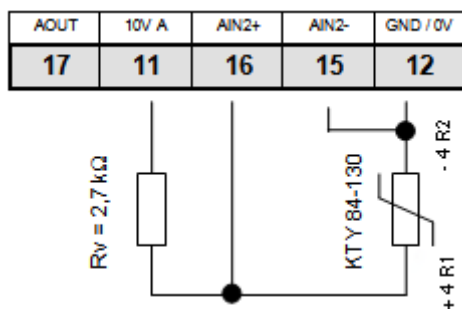

SK TU4-IOE

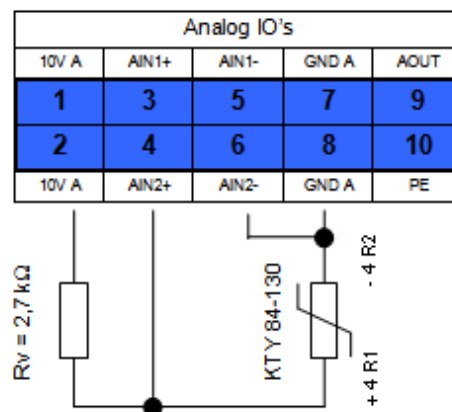

(Illustration shows a section of the terminal strips)

### Parameter settings (Analogue input 2)

The following parameters must be set for the function of the KTY84-130.

1. The motor data **P201-P207** must be set according to the rating plate.
2. The motor stator resistance **P208** is determined at 20°C with **P220 = 1**.
3. Analogue input 2 function, **P400 [-04] = 30**  
(motor temperature)
4. The mode analogue input 2 **P401 [-02] = 1**  
(negative temperatures are also measured)  
(As of firmware version: V1.2)
5. Adjustment of analogue input 2: **P402 [-02] = 1.54 V** and **P403 [-02] = 2.64 V**  
(with R<sub>V</sub> = 2.7 kΩ)
6. Adjust time constants: **P161 [-02] = 400ms** (Filter time constant is at a maximum)  
Parameter (P161) is a module parameter. It cannot be set at the frequency inverter, but must be set directly at the I/O module.  
Communication takes place by directly connecting a ParameterBox to the RS232 interface of the module, for example, or by means of connecting to the frequency converter via the system bus. (Parameter (P1101) object selection → ...)
7. Motor temperature control (display): **P739 [-03]**

### SK 1x0E

Connection of a KTY-84 to either of the two analogue inputs of the **SK 1x0E** is possible. In the following examples, analogue input 2 of the frequency inverter is used.

#### SK 1x0E

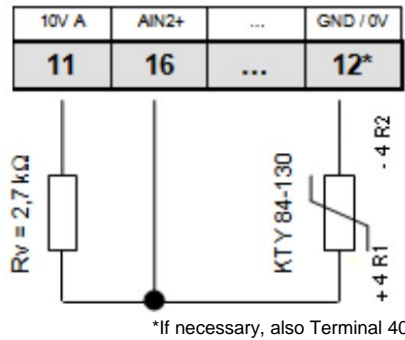

#### Parameter settings (Analogue input 2)

The following parameters must be set for the function of the KTY84-130.

1. The motor data **P201-P207** must be set according to the rating plate.
2. The motor stator resistance **P208** is determined at 20°C with **P220 = 1**.
3. Function analogue input 2, **P400 [-02] = 30**  
(Motor temperature)
4. The mode analogue input 2 **P401 [-06] = 1**  
(negative temperatures are also measured)
5. Adjustment of analogue input 2: **P402 [-06] = 1.54 V** and **P403 [-06] = 2.64 V**  
(with RV= 2.7 kΩ)
6. Adjust time constants: **P404 [-02] = 400 ms** (Filter time constant is maximum)
7. Motor temperature control (display): **P739 [-03]**

### 4.5 AS Interface (AS-i)

This section is only relevant for device of type SK 190E .

#### 4.5.1 The bus system

##### General information

The Actuator Sensor Interface (AS-Interface) is a bus system for the lower field bus level. It has been defined in the AS-Interface *Complete Specification* and standardised according to EN 50295, IEC62026.

The transfer principle is a single-master system with cyclic polling. Since the *Complete Specification V2.1* , a maximum of **31 standard slaves** using the device profile **S-7.0.**, or **62 slaves in the extended addressing mode** using the device profile **S-7.A.** could have been operated with any network structure at an unshielded two-wire line up to 100 m long.

Doubling the number of possible slave participants is realised by the double assignment of the addresses 1-31 and the “A slave” or “B slave” labelling. Slaves in the extended addressing mode are labelled by the ID code A and can be clearly identified by the master.

Devices with slave profiles **S-7.0** and **S-7.A.** can be operated together within an AS-i network with version 2.1 and higher (**master profile M4**), considering the address assignment (see example).

Permissible	Not permissible
Standard slave 1 (address 6)	Standard slave 1 (address 6)
<b>A/B slave 1 (address 7A)</b>	<b>Standard slave 2 (address 7)</b>
<b>A/B slave 2 (address 7B)</b>	<b>A/B slave 1 (address 7B)</b>
Standard slave 2 (address 8)	Standard slave 3 (address 8)

Addressing is done via the master that also provides further management functions, or via a separate addressing unit.

##### Device-specific information

The transfer of the 4-bit application data (per direction) is performed with effective error protection for standard slaves with a maximum cycle time of 5 ms. Due to the higher number of participants, for slaves in the extended addressing mode, the cycle time is doubled (*max. 10 ms*) for data sent *from the slave to the master*. Extended addressing for sending data *to the slave* cause an additional doubling of the cycle time to *max. 21 ms*.

The AS-Interface cable (yellow) transfers data and power.

#### 4.5.2 Features and technical data

The device can be directly integrated in an AS interface network is parametrised in its factory settings so that the most frequently used AS-i functionality is available immediately. Only adaptations for application-specific functions of the device or the bus system, the addressing and proper connection of the supply, BUS, sensor and actuator cables need to be carried out.

##### Features

- Electrically isolated bus interface
- Status indicator (1 LED) (only visible with the cover of the device open)
- Configuration by means of parametrisation
- 24 V DC supply of integrated AS-i module via yellow AS-i line
- Connection to device

- Via terminal strip
- or via M12 flange connector

### Technical data for AS interface

Designation	Value
AS-i supply, PWR connection (yellow cable)	24 V DC, max. 25 mA
Slave profile	S-7.A
I/O-Code	7
ID Code	A
External ID Code 1 / 2	7
Address	1A – 31A and 1B - 31B (Delivery condition 0A)
Cycle time	Slave → Master ≤ 10 ms Master → Slave ≤ 21 ms
Quantity of (BUS I/O)	4I / 4O

#### 4.5.3 Bus structure and topology

The AS-Interface network structure is optional (line, star, ring and tree structure) and is managed by an AS-Interface master as an interface between PLC and slaves. An existing network can be extended with further slaves up to a limit of 31 standard slaves or 62 slaves in the extended addressing mode. The addressing of slaves is done by the master or a respective addressing unit.

An AS-i master communicates independently and exchanges data with the connected AS-i slaves. No standard power supply units must be used in the AS-Interface network. For each AS-Interface line, only one special AS-Interface power supply unit may be used for voltage supply. This AS-Interface voltage supply is connected directly to the yellow standard cable (AS-i(+)) and AS-i(-) cable) and should be positioned as close as possible to the AS-i master to keep the voltage drop low.

To avoid interferences, the **PE connection of the AS-Interface power supply unit** (if available) **must be earthed**.

The brown **AS-i(+)** and the blue **AS-i(-)** wire of the yellow AS-Interface cable **must not be earthed**.

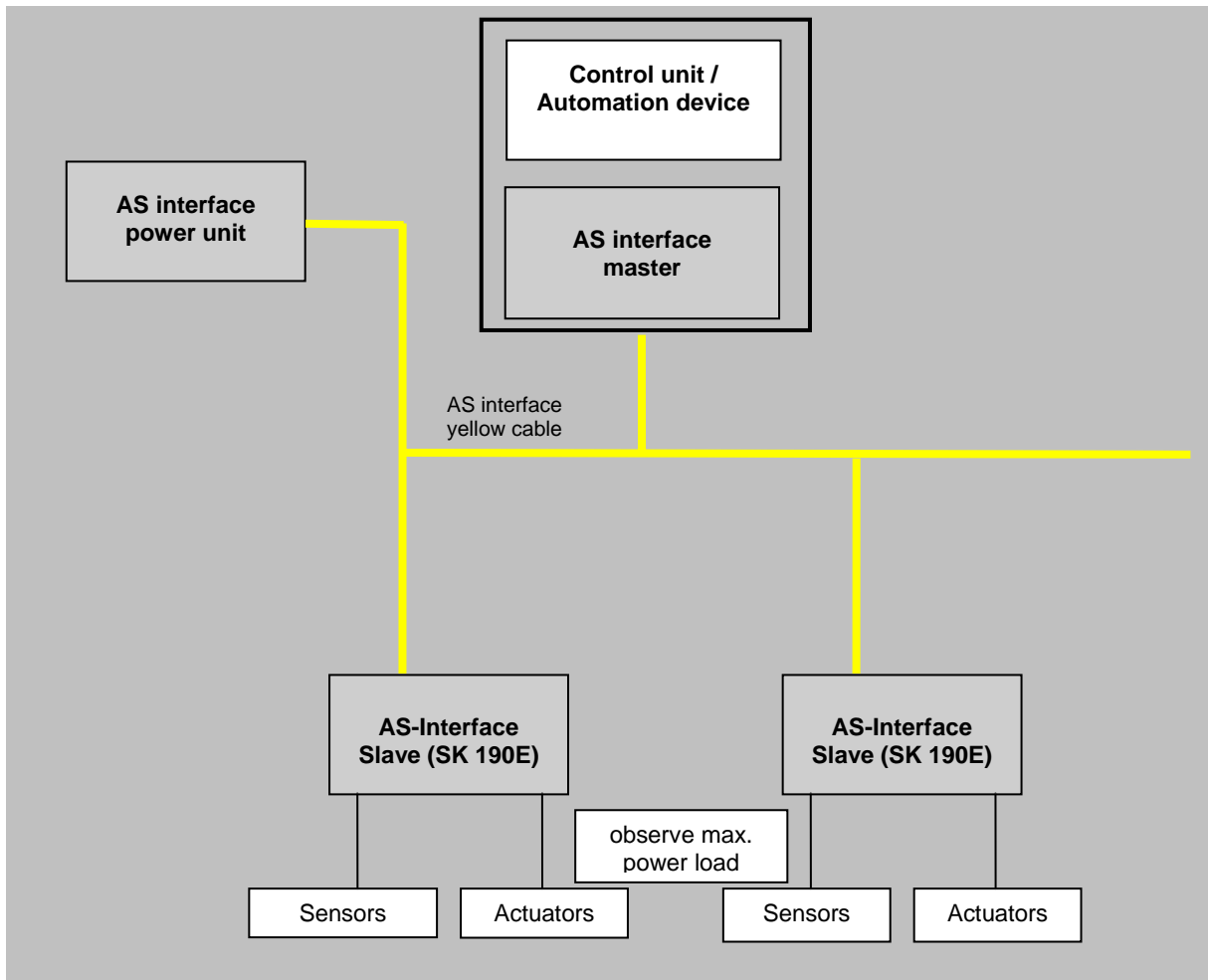

### 4.5.4 Commissioning

#### 4.5.4.1 Connection

Connection of the AS interface cable (yellow) is made via terminals 85/85 of the terminal strip and can optionally be made to an appropriately labelled M12 flange plug connector (yellow)

Details of control terminals ([📖](#) Section 2.4.3 "Electrical connection of the control unit")

Details of connector ([📖](#) Section 3.2.3.2 "Plug connectors for control connection")

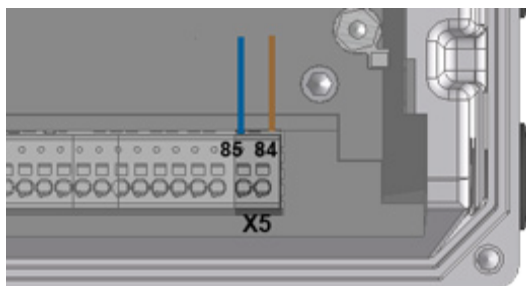

Figure 14: Connecting terminals AS-i

Type	AS Interface connection		Control voltage connection e.g. AUX line of a PELV	
	AS-i(+)	AS-i(-)	24 V DC	GND
SK 190E	84	85	- 1)	- 1)

1) The control unit of the frequency inverter is not supplied from the AS-I line. The auxiliary voltage that is required for this is generated by the device itself.

**Table 11: AS Interface, connection of signal and supply lines**

If the AS interface ("yellow cable") is not used, the normal connection requirements for the device apply (📖 Section 2.4.3 "Electrical connection of the control unit").

#### 4.5.4.2 Displays

The status of the AS interface is signalled by a multi-colour **AS-i** LED.

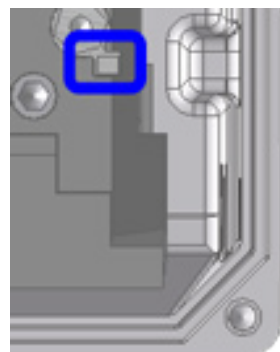

AS-i LED	Meaning
OFF	<ul style="list-style-type: none"> <li>No AS interface voltage to the module</li> <li>Connections not connected or exchanged</li> </ul>
green ON	<ul style="list-style-type: none"> <li>Normal operation (AS interface active)</li> </ul>
red ON	<ul style="list-style-type: none"> <li>No exchange of data <ul style="list-style-type: none"> <li>Slave address = 0 (slave still in factory setting)</li> <li>Slave not in LPS (list of planned slaves)</li> <li>Slave with incorrect IO/ID</li> <li>Master in STOP mode</li> <li>Reset active</li> </ul> </li> </ul>
Alternately flashing red / green Flashing (2 Hz) <sup>1)</sup>	<ul style="list-style-type: none"> <li>Peripheral error <ul style="list-style-type: none"> <li>Control unit in device not starting (AS-i voltage too low or control unit defective)</li> </ul> </li> </ul>

#### 4.5.4.3 Configuration

The most important functionality is assigned via the arrays [-01] ... [-04] of parameters (P480) and (P481).

#### Bus I/O bits

### WARNING

#### Unexpected movement due to automatic starting

In the event of a fault (communication interrupted or bus cable disconnection) the device automatically switches off, since the device enable is no longer present.

Restoration of communication may result in an automatic start and therefore unexpected movement of the drive unit. To prevent any hazard, a possible automatic start must be prevented as follows:

- If a communication error occurs, the bus master must actively set the control bits to “zero”.

Initiators can be directly connected to the digital inputs of the frequency inverter. Actuators can be connected via the available digital outputs of the device. The following connections are each provided for four reference data bits:

BUS IN	Function (P480[-01...-04])	Status		Status
		Bit 1	Bit 0	
Bit 0	Enable right	0	0	Motor is switched off
Bit 1	Enable left	0	1	Right rotation field is present at the motor
Bit 2	Fixed frequency 2 (→ P465[-02])	1	0	Left rotation field is present at the motor
Bit 3	Acknowledge fault <sup>1)</sup>	1	1	Motor is switched off

1) Acknowledge with flank 0 → 1.

For control via the bus, acknowledgement is not automatically performed by a flank at one of the enable inputs

BUS OUT	Function (P481 [-01 ... -04])	Status		Status
		Bit 1	Bit 0	
Bit 0	Inverter ready	0	0	Error active
Bit 1	Warning	0	1	Warning
Bit 2 <sup>1)</sup>	Digital-In 1 status	1	0	Start disabled
Bit 3 <sup>1)</sup>	Digital-In 2 status	1	1	Standby / Run

1) Bits 2 and 3 are directly coupled to digital inputs 1 and 2

Parallel actuation via the BUS and the digital inputs is possible. The relevant inputs are dealt with more or less as normal digital inputs. If a changeover between manual and automatic is going to take place, it must be ensured that no enable via the normal digital inputs takes place in automatic mode. This could be implemented e.g. with a three-position key switch. Position 1: "Manual left" Position 2: "Automatic" Position 3: "Manual right".

If an enable is present via one of the two "normal" digital inputs, the control bits from the bus system are ignored. An exception is the control bit "Acknowledge fault". This function is always possible in parallel, regardless of the control hierarchy. The bus master can therefore only take over control if no actuation via a digital input takes place. If "Enable left" and "Enable right" are set simultaneously, the enable is removed and the motor stops without a deceleration ramp (block voltage).

#### 4.5.4.4 Addressing

In order to use the device in an AS-i network, it must have a unique address. The address is set to 0 in the factory. This means that the device can be recognised as a "new device" by an AS-i master (prerequisite for automatic address assignment by the master).

#### Course of action

- Ensure power supply of the AS interface via the yellow AS interface cable.

- Disconnect the AS interface master during addressing
- Set the address  $\neq 0$
- Do not doubly assign addresses

In many other cases, addressing is carried out using a normal addressing device for AS interface slaves (example follows).

- Pepperl+Fuchs, VBP-HH1-V3.0-V1 (separate M12 connection for external power supply)
- IFM, AC1154 (battery operated addressing device)

The options for addressing the AS Interface Slave with an addressing device in practice are listed in the following.

### Version 1

Using an addressing device which is equipped with an **M12 connector** for connecting to the **AS-i bus**, you can incorporate yourself into a the AS interface network via an appropriate access. The prerequisite for this is that the AS interface master can be switched off.

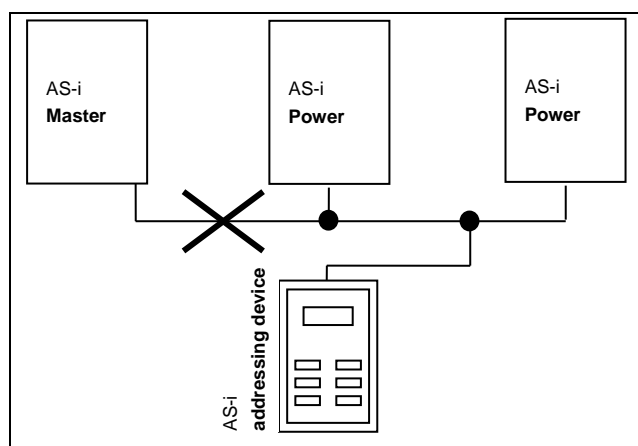

### Version 2

With an addressing device that is equipped with an **M12 connector** for connecting to the **AS-i bus** and an additional **M12 connector** for connecting an external **voltage supply**, the addressing device can be directly incorporated in the AS-i cable.

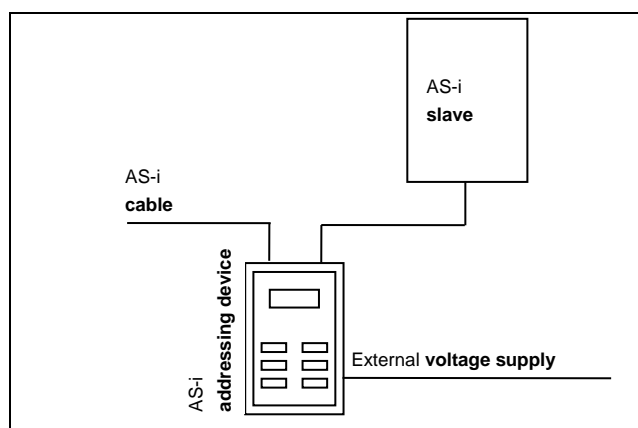

## 4.5.5 Certificate

Currently available certificates can be found on the Internet at [Link "www.nord.com"](http://www.nord.com)



## 5 Parameter

### WARNING

#### Unexpected movement

Connection of the supply voltage may directly or indirectly set the drive unit into motion. This can cause unexpected movement of the drive and the attached machine, which may result in serious or fatal injuries and/or material damage. Possible causes of unexpected movements are e.g.:

- Parameterisation of an "automatic start"
  - Incorrect parameterisation
  - Control of the device with an enabling signal from a higher level control unit (via IO or bus signals)
  - Incorrect motor data
  - Incorrect encoder connection
  - Release of a mechanical holding brake
  - External influences such as gravity or other kinetic energy which acts on the drive unit
  - In IT networks: Earth fault (short circuit to earth)
- To avoid any resulting hazard the drive or drive chain must be secured against unexpected movements (mechanical blocking and/or decoupling, provision of protection against falling, etc.) In addition, it must be ensured that there are no persons within the area of action and the danger area of the system.

### WARNING

#### Unexpected movement due to changes in the parameterisation

Parameter changes become effective immediately. Under certain conditions, dangerous situations may occur, even when the drive is in standstill. Functions such as **P428** "Automatic starting" or **P420** "Digit inputs" or the "Brake off" setting can put the drive in motion and put persons at risk due to moving parts.

Therefore:

- Changes to parameter settings must only be made when the Frequency Inverter is not enabled.
  - During parametrisation works, precautions must be taken to prevent unwanted drive movements (e.g. lifting equipment plunging down). The danger area of the system must not be entered.
-

**⚠ WARNING**

**Unexpected movement due to overload**

In case of overload of the drive there is a risk that the motor will "break down" (sudden loss of torque). An overload may be caused e.g. by inadequate dimensioning of the drive unit or by the occurrence of sudden peak loads. Sudden peak loads may be of a mechanical origin (e.g. blockage) or may be caused by extremely steep acceleration ramps (P102, P103, P426).

Depending on the type of application, "breakdown" of the motor may cause unexpected movement (e.g. dropping of loads by lifting equipment).

To prevent any risk, the following must be observed:

- For lifting equipment applications or applications with frequent large load changes, parameter P219 must remain in the factory setting (100 %).
- Do not inadequately dimension the drive unit, provide adequate overload reserves.
- If necessary, provide fall protection (e.g. for lifting equipment) or equivalent protective measures.

The relevant parameters for the device are described in the following. The parameters are accessed using a parametrisation tool (e.g. NORDCON software or control and parametrisation unit, see also (📖 Section 3.1 "Control and parametrisation options ") and therefore makes it possible to adapt the device to the drive task in the best possible way. Different device configurations can result in dependencies for the relevant parameters.

The parameters can only be accessed if the control unit of the device is active.

For this purpose, the device is equipped with a power supply which generates the 24 V DC control voltage that is required by applying the mains voltage (see (📖 Section 2.4.2 "Electrical connection of power unit").

Limited adaptations of individual functions of the relevant devices can be implemented via DIP switches. Access to the parameters of the device is essential for all other adaptations. **It should be noted that the hardware configuration (DIP switches) has priority over configuration via software (parameterisation).**

Every frequency inverter is pre-configured for a NORD motor with the same power output in the factory. All parameters can be adjusted "online". Four switchable parameter sets are available during operation. The scope of the parameters to be displayed can be influenced using the Supervisor Parameter **P003**.

The relevant parameters for the device are described in the following. Explanation of parameters which relate to the field bus options or special functionality can be found in the respective supplementary manuals.

**i Information**

**SK PAR-3H ParameterBox**

The SK PAR-3H ParameterBox must have at least software version **4.4 R2**.

The individual parameters are functionally combined into groups. The first digit of the parameter number indicates the assignment to a **menu group**:

Menu group	No.	Master function
<b>Operating displays</b>	(P0--)	Display of parameters and operational values
<b>Basic parameters</b>	(P1--)	Basic device settings, e.g. on/off switching behaviour.
<b>Motor data</b>	(P2--)	Electrical settings for the motor (motor current or start voltage (start-off voltage))
<b>PLC</b>	(P3--)	Settings for the integrated PLC
<b>Control terminals</b>	(P4--)	Assignment of functions for the inputs and outputs

Extra parameters	(P5--)	Priority monitoring functions and other parameters
Information	(P7--)	Display of operating values and status messages

---

### Information

---

#### Factory setting P523

The factory settings of the entire parameter set can be loaded at any time using parameter **P523**. For example, this can be useful during commissioning if it is not known which device parameters have been previously changed and could have an unexpected influence on the operating behaviour of the drive.

The restoration of the factory settings (**P523**) normally affects all parameters. This means that all motor data must subsequently be checked or reconfigured. However, parameter **P523** also provides a facility for excluding the motor data or the parameters relating to bus communication when the factory settings are restored.

It is advisable to back up the present settings of the frequency inverter beforehand.

---

## 5.1 Parameter overview

### Operating displays

<b>P000</b> Operating display	<b>P001</b> Selection of display value	<b>P002</b> Display factor
<b>P003</b> Display factor		

### Basic parameters

<b>P100</b> Parameter set	<b>P101</b> Copy parameter set	<b>P102</b> Acceleration time
<b>P103</b> Deceleration time	<b>P104</b> Minimum frequency	<b>P105</b> Maximum frequency
<b>P106</b> Ramp smoothing	<b>P107</b> Brake response time	<b>P108</b> Disconnection mode
<b>P109</b> DC brake current	<b>P110</b> Time DC-brake on	<b>P111</b> P-factor torque limit
<b>P112</b> Torque current limit	<b>P113</b> Jog frequency	<b>P114</b> Brake release time
<b>P120</b> Option monitoring		

### Motor data

<b>P200</b> Motor list	<b>P201</b> Nominal motor frequency	<b>P202</b> Nominal motor speed
<b>P203</b> Nominal motor current	<b>P204</b> Nominal motor voltage	<b>P205</b> Nominal motor power
<b>P206</b> Motor cos phi	<b>P207</b> Motor circuit	<b>P208</b> Stator resistance
<b>P209</b> No-load current	<b>P210</b> Static boost	<b>P211</b> Dynamic boost
<b>P212</b> Slip compensation	<b>P213</b> Amplification ISD control	<b>P214</b> Torque lead time
<b>P215</b> Boost lead time	<b>P216</b> Boost lead time	<b>P217</b> Oscillation damping
<b>P218</b> Modulation depth	<b>P219</b> Auto. flux adaptation	<b>P220</b> Par. identification
<b>P240</b> PMSM EMF voltage	<b>P241</b> PMSM inductance	<b>P243</b> Reluct. angle IPMSM
<b>P244</b> PMSM peak current	<b>P245</b> Power system stabilisation PMSM VFC	<b>P246</b> Moment of inertia
<b>P247</b> Switchover frequency VFC PMSM		

### Speed control

<b>P300</b> Servo mode	<b>P312</b> Torque current controller P	<b>P310</b> Speed controller P
<b>P311</b> Speed controller I	<b>P315</b> Field curr. ctrl. P	<b>P313</b> Torque current controller I
<b>P314</b> Torque current control limit	<b>P318</b> Field weakening controller P	<b>P316</b> Field curr. ctrl. I
<b>P317</b> Field curr. ctrl. lim.		<b>P319</b> Field weakening controller I
<b>P320</b> Weak border		
<b>P330</b> Rotor starting position detection	<b>P350</b> PLC functionality	<b>P351</b> PLC setpoint selection
<b>P353</b> Bus status via PLC	<b>P355</b> PLC integer setpoint	<b>P356</b> PLC long setpoint
<b>P360</b> PLC display value	<b>P370</b> PLC status	

### Control terminals

<b>P400</b> Function Setpoint inputs	<b>P401</b> Analogue input mode	<b>P402</b> Adjustment: 0%
<b>P403</b> Adjustment: 100%	<b>P404</b> Analogue input filter	<b>P410</b> Min. freq. Auxiliary setpoint
<b>P411</b> Max. Freq. Auxiliary setpoint	<b>P412</b> Nom. val. process ctrl.	<b>P413</b> PI control P comp.
<b>P414</b> PI control I comp.	<b>P415</b> Limit process ctrl.	<b>P416</b> Ramp time PI setpoint
<b>P417</b> Offset analogue output	<b>P418</b> Funct. analogue output	<b>P419</b> Standard analogue output
<b>P420</b> Digital inputs	<b>P426</b> Quick stop time	<b>P427</b> Emerg. stop Fault
<b>P428</b> Automatic starting	<b>P434</b> Digital output function	<b>P435</b> Dig. out scaling
<b>P436</b> Dig. out. hysteresis	<b>P460</b> Watchdog time	<b>P464</b> Fixed frequency mode
<b>P465</b> Fixed freq. Array	<b>P466</b> Minimum freq. process control	<b>P475</b> delay on/off switch
<b>P480</b> Function BusIO In Bits	<b>P481</b> Function BusIO Out Bits	<b>P482</b> Standard BusIO Out Bits
<b>P483</b> Hyst. BusIO Out Bits		

### Extra parameters

<b>P501</b> Inverter name	<b>P502</b> Master function value	<b>P503</b> Leading function output
<b>P504</b> Pulse frequency	<b>P505</b> Absolute minimum freq.	<b>P506</b> Auto. Fault acknowledgement
<b>P509</b> Control word source	<b>P510</b> Setpoint source	<b>P511</b> USS baud rate
<b>P512</b> USS address	<b>P513</b> Telegram timeout	<b>P514</b> CAN bus baud rate
<b>P515</b> CAN bus address	<b>P516</b> Skip frequency 1	<b>P517</b> Skip freq. area 1
<b>P518</b> Skip frequency 2	<b>P519</b> Skip freq. area 2	<b>P520</b> Flying start
<b>P521</b> Flying start Resolution	<b>P522</b> Flying start Offset	<b>P523</b> Factory setting
<b>P525</b> Load control max	<b>P526</b> Load control min	<b>P527</b> Load monitoring Freq.
<b>P528</b> Load monitoring delay	<b>P529</b> Mode Load control	<b>P533</b> Factor I <sup>2</sup> t
<b>P534</b> Torque shutoff lim.	<b>P535</b> I <sup>2</sup> t motor	<b>P536</b> Current limit
<b>P537</b> Pulse disconnection	<b>P539</b> Output monitoring	<b>P540</b> Mode phase sequence
<b>P541</b> Set relays	<b>P542</b> Set analogue out	<b>P543</b> Bus - Actual value
<b>P546</b> Function Setpoint Bus value	<b>P549</b> Pot Box function	
<b>P552</b> CAN master cycle	<b>P553</b> PLC setpoint	<b>P555</b> P - limit chopper
<b>P556</b> Braking resistor	<b>P557</b> Braking resistor type	<b>P558</b> Flux delay
<b>P559</b> DC Run-on time	<b>P560</b> Parameter, saving mode	

**Information**

<b>P700</b> Present Operating status	<b>P701</b> Last fault	<b>P702</b> Freq. last error
<b>P703</b> Current. last error	<b>P704</b> Volt. last error	<b>P705</b> Dc.Ink volt. last er.
<b>P706</b> P set last error	<b>P707</b> Software version	<b>P708</b> Status of digital in.
<b>P709</b> Analogue input voltage	<b>P710</b> Analogue output volt.	<b>P711</b> State of relays
<b>P714</b> Operating time	<b>P715</b> Running time	<b>P716</b> Current frequency
<b>P717</b> Current speed	<b>P718</b> Present Setpoint frequency	<b>P719</b> Actual current
<b>P720</b> Present Torque current	<b>P721</b> Actual field current	<b>P722</b> Current voltage
<b>P723</b> Voltage -d	<b>P724</b> Voltage -q	<b>P725</b> Current cos phi
<b>P726</b> Apparent power	<b>P727</b> Mechanical power	<b>P728</b> Input voltage
<b>P729</b> Torque	<b>P730</b> Field	<b>P731</b> Parameter set
<b>P732</b> Phase U current	<b>P733</b> Phase V current	<b>P734</b> Phase W current
<b>P735</b> Speed encoder	<b>P736</b> DC link current	<b>P737</b> Usage rate brake res.
<b>P738</b> Usage rate motor	<b>P739</b> Heatsink temperature	<b>P740</b> Process data Bus In
<b>P741</b> Process data Bus Out	<b>P742</b> Data base version	<b>P743</b> Inverter ID
<b>P744</b> Configuration		<b>P746</b> Option Status
<b>P747</b> Inverter Volt. Range	<b>P748</b> CANopen status	<b>P749</b> Status of DIP switches
<b>P750</b> Stat. Overcurrent	<b>P751</b> Stat. Overvoltage	<b>P752</b> Stat. Mains fault
<b>P753</b> Stat. Overtemp.	<b>P754</b> Stat. Param. loss	<b>P755</b> Stat. System error
<b>P756</b> Stat. Timeout	<b>P757</b> Stat. Customer error	<b>P760</b> Current mains current
<b>P780</b> Device ID	<b>P799</b> Op.-time last error	

## 5.2 Description of parameters

Pxxx <b>1</b>	[-01] <b>2</b>	xxxx <b>3</b> (XXXXXXXXXX)	SK <b>4</b> _	<b>5</b> S	<b>6</b> P
0 ... 36 <b>7</b>	{ 1 } <b>9</b>	[-01] = x: xxx,    XXXXXXXX [-02] = x: .xxx,    XXXXXXXX			

- 1 Parameter number
- 2 Array values
- 3 Parameter text; top: Display in ParameterBox, bottom: Meaning
- 4 Special features (e.g. only available in device model SK xxx)
- 5 (S) Parameter of type Supervisor, → depending on setting in **P003**
- 6 (P) Parameter, to which different values can be assigned depending on the selected parameter set (selection in **P100**)
- 7 Parameter value range
- 8 Description of parameters
- 9 Factory settings (default value) of parameter

### Array parameter display

Some parameters have the option of displaying settings and views in several levels ("arrays"). After the parameter is selected, the array level is displayed and must then also be selected.

If the SimpleBox SK CSX-3H is used, the array level is shown by \_ - **0 1**. With the ParameterBox SK PAR-3H (picture on right) the selection options for the array level appear at the top right of the display (Example: **[01]**).

### Array display:

#### SimpleBox SK CSX-3H

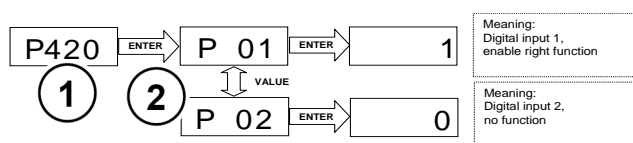

- 1 Parameter number
- 2 Array

#### ParameterBox SK PAR-3H



- 1 Parameter number
- 2 Array

## 5.2.1 Operating displays

Abbreviations used:

- **FI** = Frequency inverter
- **SW** = Software version, stored in P707.
- **S** = **Supervisor parameters** are visible or hidden depending on P003.

Parameter {factory setting}	Setting value / Description / Note		Supervisor	Parameter set																																																																																				
<b>P000</b>	<b>Operating display</b> (Operating parameter display)																																																																																							
0.01 ... 9999	In ParameterBoxes with 7-segment displays (e.g. SimpleBox) the operating value which is selected in P001 is displayed <i>online</i> . Important information about the operating status of the drive can be read out as required.																																																																																							
<b>P001</b>	<b>Display selection</b> (Display selection)																																																																																							
0 ... 65 { 0 }	Selection of operating display of a parametrisation box with 7-segment display (e.g.: SimpleBox)																																																																																							
	<table border="0"> <tr> <td>0 =</td> <td><b>Actual frequency [Hz]</b></td> <td>Currently supplied output frequency</td> </tr> <tr> <td>1 =</td> <td><b>Speed [rpm]</b></td> <td>Calculated speed</td> </tr> <tr> <td>2 =</td> <td><b>Target frequency [Hz]</b></td> <td>Output frequency that corresponds to the pending setpoint. This need not correspond with the current output frequency.</td> </tr> <tr> <td>3 =</td> <td><b>Current [A]</b></td> <td>Current measured output current</td> </tr> <tr> <td>4 =</td> <td><b>Actual torque current [A]:</b></td> <td>Torque-forming output current</td> </tr> <tr> <td>5 =</td> <td><b>Voltage [V AC]</b></td> <td>Current alternating voltage present at the device output</td> </tr> <tr> <td>6 =</td> <td><b>Link voltage [V DC]</b></td> <td>The <i>Link voltage [Vdc]</i> is the FI-internal DC voltage. Amongst other things, this depends on the level of the mains voltage.</td> </tr> <tr> <td>7 =</td> <td><b>cos Phi</b></td> <td>Current calculated value of the power factor</td> </tr> <tr> <td>8 =</td> <td><b>Apparent power [kVA]</b></td> <td>Calculated current apparent power</td> </tr> <tr> <td>9 =</td> <td><b>Effective power [kW]</b></td> <td>Calculated current effective power</td> </tr> <tr> <td>10 =</td> <td><b>Torque [%]</b></td> <td>Calculated current torque</td> </tr> <tr> <td>11 =</td> <td><b>Field [%]</b></td> <td>Calculated current field in motor</td> </tr> <tr> <td>12 =</td> <td><b>Hours of operation [h]</b></td> <td>Time for which main voltage present at device</td> </tr> <tr> <td>13 =</td> <td><b>Operating time Enable [h]</b></td> <td>"<i>Enabled operating hours</i>" is the time for which the device was enabled.</td> </tr> <tr> <td>14 =</td> <td><b>Analogue input 1 [%]</b></td> <td>Current value that is present at analogue input 1 of the device</td> </tr> <tr> <td>15 =</td> <td><b>Analogue input 2 [%]</b></td> <td>Current value that is present at analogue input 2 of the device</td> </tr> <tr> <td>16 =</td> <td><b>... 18</b></td> <td><i>Reserved</i></td> </tr> <tr> <td>19 =</td> <td><b>Heat sink temperature [°C]</b></td> <td>Current temperature of the heat sink</td> </tr> <tr> <td>20 =</td> <td><b>Actual utilisation of motor [%]</b></td> <td>Average motor utilisation, based on the known motor data (P201...P209).</td> </tr> <tr> <td>21 =</td> <td><b>Brake resistor utilisation [%]</b></td> <td>"<i>Braking resistor utilisation</i>" is the average braking resistor load, based on the known resistance data (P556...P557).</td> </tr> <tr> <td>22 =</td> <td><b>Interior temperature [°C]</b></td> <td>Current interior temperature of device (SK 54xE / SK 2xxE)</td> </tr> <tr> <td>23 =</td> <td><b>Motor temperature</b></td> <td>Measured via KTY-84</td> </tr> <tr> <td>24 =</td> <td><b>... 29</b></td> <td><i>Reserved</i></td> </tr> <tr> <td>30 =</td> <td><b>Present Target MP-S [Hz]</b></td> <td>"<i>Current motor potentiometer function setpoint with storage</i>". (P420...=71/72). The nominal value can be read out with this function or pre-set (without the drive running).</td> </tr> <tr> <td>31 =</td> <td><b>... 39</b></td> <td><i>Reserved</i></td> </tr> <tr> <td>40 =</td> <td><b>PLC control box value</b></td> <td>Visualisation mode for PLC communication</td> </tr> <tr> <td>41 =</td> <td><b>... 59</b></td> <td><i>Reserved</i></td> </tr> <tr> <td>60 =</td> <td><b>R stator ident</b></td> <td>Stator resistance determined by means of measurement (P220)</td> </tr> </table>	0 =	<b>Actual frequency [Hz]</b>	Currently supplied output frequency	1 =	<b>Speed [rpm]</b>	Calculated speed	2 =	<b>Target frequency [Hz]</b>	Output frequency that corresponds to the pending setpoint. This need not correspond with the current output frequency.	3 =	<b>Current [A]</b>	Current measured output current	4 =	<b>Actual torque current [A]:</b>	Torque-forming output current	5 =	<b>Voltage [V AC]</b>	Current alternating voltage present at the device output	6 =	<b>Link voltage [V DC]</b>	The <i>Link voltage [Vdc]</i> is the FI-internal DC voltage. Amongst other things, this depends on the level of the mains voltage.	7 =	<b>cos Phi</b>	Current calculated value of the power factor	8 =	<b>Apparent power [kVA]</b>	Calculated current apparent power	9 =	<b>Effective power [kW]</b>	Calculated current effective power	10 =	<b>Torque [%]</b>	Calculated current torque	11 =	<b>Field [%]</b>	Calculated current field in motor	12 =	<b>Hours of operation [h]</b>	Time for which main voltage present at device	13 =	<b>Operating time Enable [h]</b>	" <i>Enabled operating hours</i> " is the time for which the device was enabled.	14 =	<b>Analogue input 1 [%]</b>	Current value that is present at analogue input 1 of the device	15 =	<b>Analogue input 2 [%]</b>	Current value that is present at analogue input 2 of the device	16 =	<b>... 18</b>	<i>Reserved</i>	19 =	<b>Heat sink temperature [°C]</b>	Current temperature of the heat sink	20 =	<b>Actual utilisation of motor [%]</b>	Average motor utilisation, based on the known motor data (P201...P209).	21 =	<b>Brake resistor utilisation [%]</b>	" <i>Braking resistor utilisation</i> " is the average braking resistor load, based on the known resistance data (P556...P557).	22 =	<b>Interior temperature [°C]</b>	Current interior temperature of device (SK 54xE / SK 2xxE)	23 =	<b>Motor temperature</b>	Measured via KTY-84	24 =	<b>... 29</b>	<i>Reserved</i>	30 =	<b>Present Target MP-S [Hz]</b>	" <i>Current motor potentiometer function setpoint with storage</i> ". (P420...=71/72). The nominal value can be read out with this function or pre-set (without the drive running).	31 =	<b>... 39</b>	<i>Reserved</i>	40 =	<b>PLC control box value</b>	Visualisation mode for PLC communication	41 =	<b>... 59</b>	<i>Reserved</i>	60 =	<b>R stator ident</b>	Stator resistance determined by means of measurement (P220)			
0 =	<b>Actual frequency [Hz]</b>	Currently supplied output frequency																																																																																						
1 =	<b>Speed [rpm]</b>	Calculated speed																																																																																						
2 =	<b>Target frequency [Hz]</b>	Output frequency that corresponds to the pending setpoint. This need not correspond with the current output frequency.																																																																																						
3 =	<b>Current [A]</b>	Current measured output current																																																																																						
4 =	<b>Actual torque current [A]:</b>	Torque-forming output current																																																																																						
5 =	<b>Voltage [V AC]</b>	Current alternating voltage present at the device output																																																																																						
6 =	<b>Link voltage [V DC]</b>	The <i>Link voltage [Vdc]</i> is the FI-internal DC voltage. Amongst other things, this depends on the level of the mains voltage.																																																																																						
7 =	<b>cos Phi</b>	Current calculated value of the power factor																																																																																						
8 =	<b>Apparent power [kVA]</b>	Calculated current apparent power																																																																																						
9 =	<b>Effective power [kW]</b>	Calculated current effective power																																																																																						
10 =	<b>Torque [%]</b>	Calculated current torque																																																																																						
11 =	<b>Field [%]</b>	Calculated current field in motor																																																																																						
12 =	<b>Hours of operation [h]</b>	Time for which main voltage present at device																																																																																						
13 =	<b>Operating time Enable [h]</b>	" <i>Enabled operating hours</i> " is the time for which the device was enabled.																																																																																						
14 =	<b>Analogue input 1 [%]</b>	Current value that is present at analogue input 1 of the device																																																																																						
15 =	<b>Analogue input 2 [%]</b>	Current value that is present at analogue input 2 of the device																																																																																						
16 =	<b>... 18</b>	<i>Reserved</i>																																																																																						
19 =	<b>Heat sink temperature [°C]</b>	Current temperature of the heat sink																																																																																						
20 =	<b>Actual utilisation of motor [%]</b>	Average motor utilisation, based on the known motor data (P201...P209).																																																																																						
21 =	<b>Brake resistor utilisation [%]</b>	" <i>Braking resistor utilisation</i> " is the average braking resistor load, based on the known resistance data (P556...P557).																																																																																						
22 =	<b>Interior temperature [°C]</b>	Current interior temperature of device (SK 54xE / SK 2xxE)																																																																																						
23 =	<b>Motor temperature</b>	Measured via KTY-84																																																																																						
24 =	<b>... 29</b>	<i>Reserved</i>																																																																																						
30 =	<b>Present Target MP-S [Hz]</b>	" <i>Current motor potentiometer function setpoint with storage</i> ". (P420...=71/72). The nominal value can be read out with this function or pre-set (without the drive running).																																																																																						
31 =	<b>... 39</b>	<i>Reserved</i>																																																																																						
40 =	<b>PLC control box value</b>	Visualisation mode for PLC communication																																																																																						
41 =	<b>... 59</b>	<i>Reserved</i>																																																																																						
60 =	<b>R stator ident</b>	Stator resistance determined by means of measurement (P220)																																																																																						



61 =	<b>R rotor ident</b>	the rotor resistance determined by measurement ((P220) Function 2)
62 =	<b>L stray stator ident</b>	the stray inductance determined by measurement ((P220) Function 2)
63 =	<b>L stator ident</b>	the inductance determined by measurement ((P220) Function 2)
65 =		<i>Reserved</i>

<b>P002</b>	<b>Display factor</b> ( <i>Display factor</i> )		<b>S</b>	
0.01 ... 999.99 { 1.00 }	The selected operating value in parameter P001 >Select of display< is multiplied with the scaling factor in P000 and displayed in >Operating parameter display<. It is therefore possible to display system-specific operating such as e.g. the throughput quantity			
<b>P003</b>	<b>Supervisor code</b> ( <i>Supervisor code</i> )			
0 ... 9999 { 1 }	<b>0</b> = The supervisor parameters and groups P3xx/P6xx are not visible, otherwise all. <b>1</b> = All parameters are visible, except groups P3xx and P6xx. <b>2</b> = All parameters are visible, except group P6xx. <b>3</b> = All parameters are visible. <b>4</b> = ... 9999, only parameters P001 and P003 are visible.			
	<b>i</b> <b>Information</b>	<b>Display via NORDCON</b>		
	If parameterisation is carried out with the NORDCON software, the settings 4 ... 9999 the settings are as for the 0 setting. Settings 1 and 2 behave like setting 3.			

### 5.2.2 Basic parameters

Parameter {factory setting}	Setting value / Description / Note		Supervisor	Parameter set
<b>P100</b>	<b>Parameter set</b> ( <i>Parameter set</i> )		<b>S</b>	
0 ... 3 { 0 }	Selection of the parameters sets to be parameterised. 4 parameter sets are available. The parameters to which different values can also be assigned in the 4 parameter sets are known as "parameter set-dependent" and are marked with a " <b>P</b> " in the header in the following descriptions. The operating parameter set is selected using appropriately parametrised digital inputs or by means of BUS actuation.  If enabled via the keyboard (SimpleBox, ControlBox, PotentiometerBox or ParameterBox), the operating parameter set will match the settings in P100.			
<b>P101</b>	<b>Copy parameter set</b> ( <i>Copy parameter set</i> )		<b>S</b>	
0 ... 4 { 0 }	After confirmation with the OK / ENTER key, a copy of the parameter set selected in P100 >Parameter set< is written to the parameter set dependent on the value selected here <b>0</b> = Do not copy <b>1</b> = <b>Copy actual to P1</b> : Copies the active parameter set to parameter set 1 <b>2</b> = <b>Copy actual to P2</b> : Copies the active parameter set to parameter set 2 <b>3</b> = <b>Copy actual to P3</b> : Copies the active parameter set to parameter set 3 <b>4</b> = <b>Copy actual to P4</b> : Copies the active parameter set to parameter set 4			

<b>P102</b>	<b>Acceleration time</b> (Acceleration time)			<b>P</b>
0 ... 320.00 sec { 2.00 }	<p>The start-up time is the time corresponding to the linear frequency rise from 0 Hz to the set maximum frequency (P105). If an actual setpoint of &lt;100 % is being used, the acceleration time is reduced linearly according to the setpoint which is set.</p> <p>The acceleration time can be extended by certain circumstances, e.g. FI overload, setpoint lag, smoothing, or if the current limit is reached.</p> <p><b>NOTE:</b></p> <p>Care must be taken that the parameter values are realistic. A setting of P102 = 0 is not permissible for drive units!</p> <p><b>Notes on ramp gradient:</b></p> <p>Amongst other things, the ramp gradient is governed by the inertia of the rotor.</p> <p>A ramp with a gradient which is too steep may result in the "inversion" of the motor.</p> <p>In general, extremely steep ramps (e.g.: 0 - 50 Hz in &lt; 0.1 s) should be avoided, as may cause damage to the frequency inverter.</p>			
<b>P103</b>	<b>Braking time</b> (Braking time)			<b>P</b>
0 ... 320.00 sec { 2.00 }	<p>The braking time is the time corresponding to the linear frequency reduction from the set maximum frequency to 0 Hz (P105). If an actual setpoint &lt;100 % is being used, the deceleration time reduces accordingly.</p> <p>The braking time can be extended by certain circumstances, e.g. by the selected &gt;Switch-off mode&lt; (P108) or &gt;Ramp smoothing&lt; (P106).</p> <p><b>NOTE:</b></p> <p>Care must be taken that the parameter values are realistic. A setting of P103 = 0 is not permissible for drive units!</p> <p><b>Notes concerning ramp steepness:</b> see parameter (P102)</p>			
<b>P104</b>	<b>Minimum frequency</b> (Minimum frequency)			<b>P</b>
0.0 ... 400.0 Hz { 0.0 }	<p>The minimum frequency is the frequency supplied by the FI as soon as it is enabled and no additional setpoint is set.</p> <p>In combination with other setpoints (e.g. analog setpoint of fixed frequencies) these are added to the set minimum frequency.</p> <p>This frequency is undershot when</p> <ol style="list-style-type: none"> <li>the drive is accelerated from standstill.</li> <li>The FI is blocked. The frequency then reduces to the absolute minimum (P505) before it is blocked.</li> <li>The FI reverses. The reverse in the rotation field takes place at the absolute minimum frequency (P505).</li> </ol> <p>This frequency can be continuously undershot if, during acceleration or braking, the function "Maintain frequency" (Function Digital input = 9) is executed.</p>			

<b>P105</b>	<b>Maximum frequency</b> <i>(Maximum frequency)</i>			<b>P</b>
0.1 ... 400.0 Hz { 50.0 }	<p>The frequency supplied by the FI after being enabled and once the maximum setpoint is present; e.g. analogue setpoint according to P403, a correspondingly fixed frequency or maximum via SimpleBox/ParameterBox.</p> <p>This frequency can only be exceeded by the slip compensation (P212), the function "Maintain the freq." (Digital input function = 9) or the switch to another parameter set with lower maximum frequency.</p> <p>Maximum frequencies are subject to certain restrictions, e.g.</p> <ul style="list-style-type: none"> <li>• Restrictions in weak field operation,</li> <li>• Compliance with mechanically permissible speeds,</li> <li>• PMSM: Restriction of the maximum frequency to a value which is slightly above the nominal frequency. This value is calculated from the motor data and the input voltage.</li> </ul>			
<b>P106</b>	<b>Ramp smoothing</b> <i>(Ramp smoothing)</i>			<b>P</b>

0 ... 100 %  
{ 0 }

This parameter enables a smoothing of the acceleration and deceleration ramps. This is necessary for applications where gentle, but dynamic speed change is important.

Ramp smoothing is carried out for every setpoint change.

The value to be set is based on the set acceleration and deceleration time, however values <10% have no effect.

The following then applies for the entire acceleration or deceleration time, including rounding:

$$t_{\text{tot ACCELERATION TIME}} = t_{P102} + t_{P102} \cdot \frac{P106 [\%]}{100\%}$$

$$t_{\text{tot DECELERATION TIME}} = t_{P103} + t_{P103} \cdot \frac{P106 [\%]}{100\%}$$

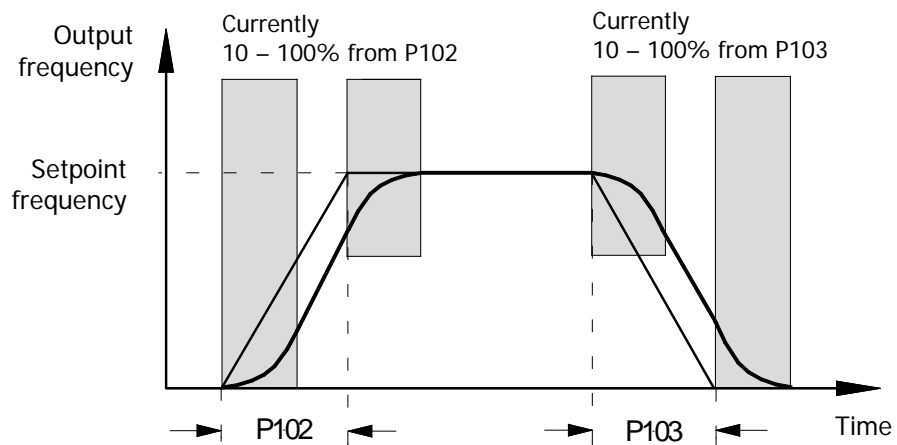

- Note:** Under the following conditions ramp rounding is switched off or replaced with a linear ramp with extended times:
- Acceleration values (+/-) less than 1 Hz/s
  - Acceleration values (+/-) greater than 1 Hz/ms
  - Rounding values less than 10 %

<b>P107</b>	<b>Brake reaction time</b> <i>(Brake reaction time)</i>			<b>P</b>
-------------	--	--	--	----------

0 ... 2.50 s  
{ 0.00 }

Electromagnetic brakes have a physically-dependent delayed reaction time when actuated. This can cause a dropping of the load for lifting applications, as the brake only takes over the load after a delay.

The reaction time must be taken into consideration by setting parameter P107.

Within the adjustable application time, the FI supplies the set absolute minimum frequency (P505) and so prevents movement against the brake and load drop when stopping.

If a time > 0 is set in P107 or P114, at the moment the FI is switched on, the level of the excitation current (field current) is checked. If no magnetising current is present, the FI remains in magnetising mode and the motor brake is not released.

In order to achieve a shut-down and an error message (E016) in this case, P539 must be set to 2 or 3.

See also the parameter >Release time< P114

**Recommendation for applications:**

Lifting equipment with brake, without speed feedback    Lifting equipment with brake

P114 = 0.02...0.4 s \*

P107 = 0.02...0.4 s \*

P201...P208 = Motor data

P434 = 1 (ext. brake)

P505 = 2...4 Hz

for safe start-up

P112 = 401 (off)

P536 = 2.1 (off)

P537 = 150 %

P539 = 2/3 (ISD monitoring)

to prevent load drops

P214 = 50...100 % (precontrol)

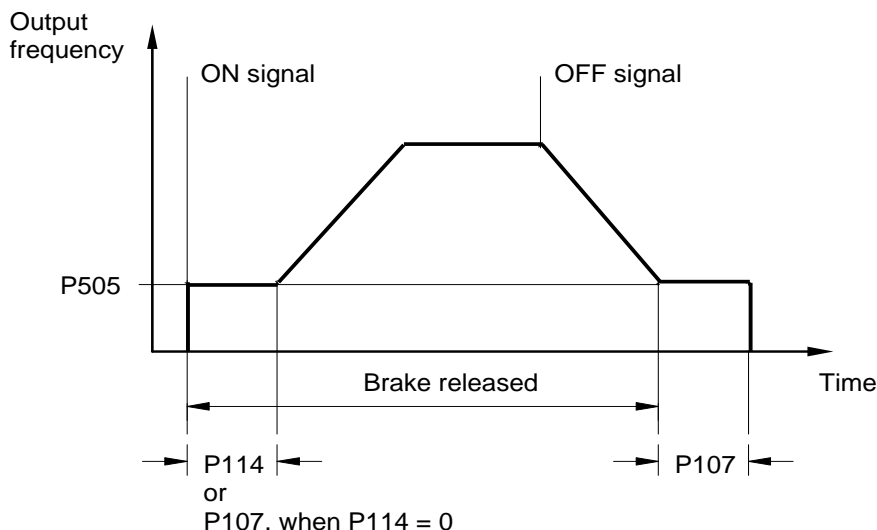

\* Settings (P107/114) depending on brake type and motor size. At low power levels (< 1.5 kW) lower values apply for higher power ratings (> 4.0 kW) are larger values.

** Information**

**Brake control**

The relevant connection on the frequency inverter must be used to actuate the electromechanical brake (particularly with lifting mechanisms), if present . The minimum absolute frequency (P505) should never be less than 2.0 Hz.

P108	Disconnection mode (Disconnection mode)		S	P
0 ... 13 { 1 }	This parameter determines the manner in which the output frequency is reduced after "Blocking" (controller enable → Low).			
	<p><b>0 = Block voltage:</b> The output signal is switched off immediately. The FI no longer supplies an output frequency. The motor is only braked by mechanical friction. Switching the FI on again immediately can lead to an error message.</p> <p><b>1 = Ramp:</b> The current output frequency is reduced in proportion to the remaining deceleration time, from P103/P105. The DC run-on follows the end of the ramp (→ P559).</p> <p><b>2 = Ramp with delay:</b> as for 1 "Ramp", however for generational operation the brake ramp is extended, or for static operation the output frequency is increased. Under certain conditions, this function can prevent overload switch off or reduce brake resistance power dissipation.</p> <p><b>NOTE:</b> This function must not be programmed if defined deceleration is required, e.g. with lifting mechanisms.</p> <p><b>3 = Immediate DC braking:</b> The FI switches immediately to the preselected DC current (P109). This DC current is supplied for the remaining proportion of the &gt;DC brake time&lt; (P110). Depending on the relationship, actual output frequency to max. frequency (P105), the &gt;Time DC brake on&lt; is shortened. The time taken for the motor to stop depends on the application. The time taken to stop depends on the mass inertia of the load and the DC current set (P109). With this type of braking, no energy is returned to the FI; heat loss occurs mainly in the motor rotor.</p> <p><b>Not for PMSM motors!</b></p> <p><b>4 = Const. brake distance, "Constant brake distance":</b> The brake ramp is delayed in starting if the equipment is <u>not</u> being driven at the maximum output frequency (P105). This results in an approximately similar braking distance for different frequencies.</p> <p><b>NOTE:</b> This function cannot be used as a positioning function. This function should not be combined with ramp smoothing (P106).</p> <p><b>5 = Combined braking, "Combined braking":</b> Dependent on the actual link voltage (UZV), a high frequency voltage is switched to the basic frequency (only for linear characteristic curves, P211 = 0 and P212 = 0). The braking time (P103) is complied with if possible. → Additional heating in the motor!</p> <p><b>Not for PMSM motors!</b></p> <p><b>6 = Quadratic ramp:</b> The brake ramp does not follow a linear path, but rather a decreasing quadratic one.</p> <p><b>7 = Quad. ramp with delay, "Quadratic ramp with delay":</b> Combination of functions 2 and 6</p> <p><b>8 = Quad. comb. braking, "Quadratic combined braking":</b> Combination of functions 5 and 6</p> <p><b>Not for PMSM motors!</b></p> <p><b>9 = Const. acceln. power, "Constant acceleration power":</b> Only applies in field weakening range! The drive is accelerated or braked using constant electrical power. The course of the ramps depends on the load.</p> <p><b>10 = Distance calculator:</b> Constant distance between actual frequency / speed and the set minimum output frequency (P104).</p> <p><b>11 = Const. acceln. power with delay, "Constant acceleration power with delay":</b> Combination of functions 2 and 9.</p> <p><b>12 = Const. acceln. power mode 3, "Constant acceleration power mode 3"</b> as for 11, however with additional relief of the brake chopper</p> <p><b>13 = Disconnection delay, "Ramp with disconnection delay":</b> as for 1 "Ramp", however, before the brake is applied, the drive unit remains at the absolute minimum frequency set in parameter (P505) for the time specified in parameter (P110). Application example: Re-positioning for crane control</p>			

<b>P109</b>	<b>DC brake current</b> (DC brake current)		<b>S</b>	<b>P</b>
0 ... 250 % { 100 }	<p>Current setting for the functions of DC current braking (P108 = 3) and combined braking (P108 = 5).</p> <p>The correct setting value depends on the mechanical load and the required deceleration time. A higher setting brings large loads to a standstill more quickly.</p> <p>The 100% setting relates to a current value as stored in the &gt;Nominal current&lt; parameter P203.</p> <p><b>NOTE:</b> The amount of DC current (0 Hz) which the FI can supply is limited. For this value, please refer to the table in Section 8.4 "Reduced output power", column: 0 Hz. In the basic setting this limiting value is about 110 %.</p> <p><b>DC braking Not for PMSM motors!</b></p>			
<b>P110</b>	<b>Time DC-brake on</b> (DC braking time on)		<b>S</b>	<b>P</b>
0.00 ... 60.00 sec { 2.00 }	<p>The time during which current selected in parameter P109 is applied to the motor for the function "DC braking" selected in parameter P108 (P108 = 3).</p> <p>Depending on the relationship of the actual output frequency to the max. frequency (P105), the &gt;DC brake time&lt; is shortened.</p> <p>The time starts running with the removal of the enable and can be interrupted by fresh enabling.</p> <p><b>DC braking Not for PMSM motors!</b></p>			
<b>P111</b>	<b>P factor torque limit</b> (P factor torque limit)		<b>S</b>	<b>P</b>
25 ... 400 % { 100 }	<p>Directly affects the behaviour of the drive at torque limit. The basic setting of 100% is sufficient for most drive tasks.</p> <p>If values are too high the drive tends to vibrate as it reaches the torque limit. If values are too low, the programmed torque limit can be exceeded.</p>			
<b>P112</b>	<b>Torque current limit</b> (torque current limit)		<b>S</b>	<b>P</b>
25 ... 400 % / 401 { 401 }	<p>With this parameter, a limit value for the torque-generating current can be set. This can prevent mechanical overloading of the drive. It cannot provide any protection against mechanical blockages (movement to stops). A slipping clutch which acts as a safety device must be provided.</p> <p>The torque current limit can also be set over an infinite range of settings using an analogue input. The maximum setpoint (see 100% calibration, P403[-01] . [-06]) the corresponds to the setting in P112.</p> <p>The limit value 20% of current torque cannot be undershot by a smaller analogue setpoint (P400[-01] ... [-09] = 11 or 12). In contrast, in servo mode ((P300) = "1") as of firmware version V 1.3 a limiting value of 0% is possible (older firmware versions: min. 10%)!</p> <p><b>401 = OFF</b> means the switch-off of the torque current limit! This is also the basic setting for the FI.</p>			
<b>P113</b>	<b>Jog frequency</b> (Jog frequency)		<b>S</b>	<b>P</b>
-400.0 ... 400.0 Hz { 0.0 }	<p>When using the <b>SimpleBox</b> or <b>ParameterBox</b> to control the FI, the jog frequency is the initial value following successful enabling.</p> <p>Alternatively, when control is via the control terminals, the jog frequency can be activated via one of the digital inputs.</p> <p>The setting of the jog frequency can be done directly via this parameter or, if the FI is enabled via the keyboard, by pressing the OK key. In this case, the actual output frequency is set in parameter P113 and is then available for the next start.</p> <p><b>NOTE:</b> Specified setpoints via the control terminals, e.g. jog frequency, fixed frequencies or analogue setpoints, are generally added with the correct sign. The set maximum frequency (P105) cannot be exceeded and the minimum frequency (P104) cannot be undershot.</p>			



### 5.2.3 Motor data / Characteristic curve parameters

Parameter {factory setting}	Setting value / Description / Note		Supervisor	Parameter set
<b>P200</b>	<b>Motor list</b> (Motor list)			<b>P</b>

0 ... 73  
{ 0 }

The factory settings for the motor data can be edited with this parameter. A 4-pole IE1 three-phase standard motor with the FI rated power is set at the factory in parameters **P201 ... P209**.  
By selecting one of the possible digits and pressing the ENTER key, all of the motor parameters (**P201 ... P209**) are set to the selected standard power. The motor data is based on a 4-pole three-phase standard motor. The motor data for NORD IE4 motors can be found in the final section of the list.

**Note:**

As **P200** is = 0 again after input acknowledgement, the set motor can be controlled via the parameter **P205**.

 **Information**





If IE2/IE3 motors are used, after selecting an IE1 motor (**P200**), the motor data in **P201 ... P209** must be adapted to the data on the motor type plate.

**0 = No change**

**1 = No motor:** In this setting, the FI operates without current control, slip compensation and pre-magnetising time, and is therefore not recommended for motor applications. Possible applications are induction furnaces or other applications with coils and transformers. The following motor data is set here: 50.0 Hz / 1500 rpm / 15.0 A / 400 V / 0.00 kW /  $\cos \varphi=0.90$  / Stern /  $R_S 0.01 \Omega$  /  $I_{LEER} 6.5 A$

<b>2 =</b> 0.12kW 230V	<b>19 =</b> 1.0 PS 230V	<b>36 =</b> 3.0 kW 400V	<b>52 =</b> 0.75kW 230V 80T1/4
<b>3 =</b> 0.16PS 230V	<b>20 =</b> 0.75kW 400V	<b>37 =</b> 4.0 PS 460V	<b>53 =</b> 1.10kW 230V 90T1/4
<b>4 =</b> 0.18kW 400V	<b>21 =</b> 1.0 PS 460V	<b>38 =</b> 4.0 kW 230V	<b>54 =</b> 1.10kW 230V 80T1/4
<b>5 =</b> 0.25PS 460V	<b>22 =</b> 1.1 kW 230V	<b>39 =</b> 5.0 PS 230V	<b>55 =</b> 1.10kW 400V 80T1/4
<b>6 =</b> 0.25kW 230V	<b>23 =</b> 1.5 PS 230V	<b>40 =</b> 4.0 kW 400V	<b>56 =</b> 1.50kW 230V 90T3/4
<b>7 =</b> 0.33PS 230V	<b>24 =</b> 1.1 kW 400V	<b>41 =</b> 5.0 PS 460V	<b>57 =</b> 1.50kW 230V 90T1/4
<b>8 =</b> 0.25kW 400V	<b>25 =</b> 1.5 PS 460V	<b>42 =</b> 5.5 kW 230V	<b>58 =</b> 1.50kW 400V 90T1/4
<b>9 =</b> 0.33PS 460V	<b>26 =</b> 1.5 kW 230V	<b>43 =</b> 7.5 PS 230V	<b>59 =</b> 1.50kW 400V 80T1/4
<b>10 =</b> 0.37kW 230V	<b>27 =</b> 2.0 PS 230V	<b>44 =</b> 5.5 kW 400V	<b>60 =</b> 2.20kW 230V 100T2/4
<b>11 =</b> 0.50PS 230V	<b>28 =</b> 1.5 kW 400V	<b>45 =</b> 7.5 PS 460V	<b>61 =</b> 2.20kW 230V 90T3/4
<b>12 =</b> 0.37kW 400V	<b>29 =</b> 2.0 PS 460V	<b>46 =</b> 7.5 kW 230V	<b>62 =</b> 2.20kW 400V 90T3/4
<b>13 =</b> 0.50PS 460V	<b>30 =</b> 2.2 kW 230V	<b>47 =</b> 10.0 PS 230V	<b>63 =</b> 2.20kW 400V 90T1/4
<b>14 =</b> 0.55kW 230V	<b>31 =</b> 3.0 PS 230V	<b>48 =</b> 7.5 kW 400V	<b>64 =</b> 3.00kW 230V 100T5/4
<b>15 =</b> 0.75PS 230V	<b>32 =</b> 2.2 kW 400V	<b>49 =</b> 10.0 PS 460V	<b>65 =</b> 3.00kW 230V 100T2/4
<b>16 =</b> 0.55kW 400V	<b>33 =</b> 3.0 PS 460V	<b>50 =</b> 11.0 kW 400V	<b>66 =</b> 3.00kW 400V 100T2/4
<b>17 =</b> 0.75PS 460V	<b>34 =</b> 3.0 kW 230V	<b>51 =</b> 15.0 PS 460V	<b>67 =</b> 3.00kW 400V 90T3/4
<b>18 =</b> 0.75kW 230V	<b>35 =</b> 4.0 PS 230V		<b>68 =</b> 4.00kW 230V 100T5/4
			<b>69 =</b> 4.00kW 400V 100T5/4
			<b>70 =</b> 4.00kW 400V 100T2/4
			<b>71 =</b> 5.50kW 400V 100T5/4





<b>P201</b>  10.0 ... 399.9 Hz { see information }	<b>Nominal frequency</b> <i>(Nominal frequency)</i>  The motor frequency determines the V/f break point at which the FI supplies the nominal voltage ( <b>P204</b> ) at the output.   Information  <b>Default setting</b> The default setting depends on the nominal power of the FI and the setting in <b>P200</b> .		<b>S</b>	<b>P</b>
<b>P202</b>  150 ... 24000 rpm { see information }	<b>Nominal speed</b> <i>(Nominal speed)</i>  The nominal motor speed is important for correct calculation and control of the motor slip and the speed display ( <b>P001</b> = 1).   Information  <b>Default setting</b> The default setting depends on the nominal power of the FI and the setting in <b>P200</b> .		<b>S</b>	<b>P</b>
<b>P203</b>  0.1 ... 1000.0 A { see information }	<b>Nominal current</b> <i>(Nominal current)</i>  The nominal motor current is a decisive parameter for current vector control.   Information  <b>Default setting</b> The default setting depends on the nominal power of the FI and the setting in <b>P200</b> .		<b>S</b>	<b>P</b>
<b>P204</b>  100 ... 800 V { see information }	<b>Nominal voltage</b> <i>(Nominal voltage)</i>  The nominal voltage matches the mains voltage to the motor voltage. In combination with the nominal frequency, the voltage/frequency characteristic curve is produced.   Information  <b>Default setting</b> The default setting depends on the nominal power of the FI and the setting in <b>P200</b> .		<b>S</b>	<b>P</b>
<b>P205</b>  0.00 ... 250.00 kW { see information }	<b>Nominal power</b> <i>(Nominal power)</i>  The motor nominal power controls the motor set via <b>P200</b> .   Information  <b>Default setting</b> The default setting depends on the nominal power of the FI and the setting in <b>P200</b> .			<b>P</b>
<b>P206</b>  0.50 ... 0.95 { see information }	<b>Cos phi</b> <i>(Cos <math>\varphi</math>)</i>  The motor cos $\varphi$ is a decisive parameter for current vector control.		<b>S</b>	<b>P</b>

 Information

**Default setting**

The default setting depends on the nominal power of the FI and the setting in **P200**.

<b>P207</b>	<b>Star Delta con.</b> ( <i>Star Delta con.</i> )		<b>S</b>	<b>P</b>
0 ... 1 { see information }	<p><b>0 = Star                      1 = Delta</b></p> <p>The motor circuit is decisive for stator resistance measurement (<b>P220</b>) and therefore for current vector control.</p>			
	<p> Information</p> <p><b>Default setting</b></p> <p>The default setting depends on the nominal power of the FI and the setting in <b>P200</b>.</p>			
<b>P208</b>	<b>Stator resistance</b> ( <i>Stator resistance</i> )		<b>S</b>	<b>P</b>
0.00 ... 300.00 Ω { see information }	<p>Motor stator resistance ⇒ Resistance of a phase winding with a three-phase motor.</p> <p>Has a direct influence on the current control of the FI. A value which is too high may result in overcurrent; a value which is too low may result in low motor torque.</p> <p>Parameter <b>P220</b> can be used for simple measurement. Parameter <b>P208</b> can be used for manual setting or as information on the automatic measurement result.</p> <p><b>Note:</b></p> <p>For optimum functioning of the current vector control, the stator resistance must be measured automatically by the FI.</p>			
	<p> Information</p> <p><b>Default setting</b></p> <p>The default setting depends on the nominal power of the FI and the setting in <b>P200</b>.</p>			
<b>P209</b>	<b>No-load current</b> ( <i>No-load current</i> )		<b>S</b>	<b>P</b>
0.0 ... 1000.0 A { see information }	<p>This value is always calculated automatically from the motor data if there is a change in the parameter <b>P206</b> “cos φ” and parameter <b>P203</b> “Nominal current”.</p> <p><b>Note:</b> If the value is to be entered directly, then it must be set as the last value of the motor data. This is the only way to ensure that the value will not be overwritten.</p>			
	<p> Information</p> <p><b>Default setting</b></p> <p>The default setting depends on the nominal power of the FI and the setting in <b>P200</b>.</p>			
<b>P210</b>	<b>Static boost</b> ( <i>Static boost</i> )		<b>S</b>	<b>P</b>
0 ... 400 % { 100 }	<p>The static boost affects the current that generates the magnetic field. This is equivalent to the no load current of the respective motor and is therefore <u>load-independent</u>. The no load current is calculated using the motor data. The factory setting of 100% is sufficient for normal applications.</p>			

<b>P211</b>	<b>Dynamic boost</b> ( <i>Dynamic boost</i> )		<b>S</b>	<b>P</b>
0 ... 150 % { 100 }	<p>The dynamic boost affects the torque generating current and is therefore a load-dependent parameter. The factory 100% setting is also sufficient for typical applications.</p> <p>Too high a value can lead to overcurrent in the FI. Under load therefore, the output voltage will be raised too sharply. Too low a value will lead to insufficient torque.</p>			
	<p><b>i</b> <b>Information</b></p> <p><b>U/f – characteristic curve</b></p> <p>For certain applications, particularly those with high centrifugal masses (e.g. fan drives) it may be necessary to control the motor using a U/f characteristic curve. For this, parameters <b>P211</b> and <b>P212</b> must each be set to 0%.</p>			
<b>P212</b>	<b>Slip compensation</b> ( <i>Slip compensation</i> )		<b>S</b>	<b>P</b>
0 ... 150% { 100 }	<p>The slip compensation increases the output frequency, dependent on load, to keep the asynchronous motor speed approximately constant.</p> <p>The factory setting of 100% is optimal when using DC asynchronous motors and correct motor data has been set.</p> <p>If several motors (different loads or outputs) are operated with one FI, the slip compensation P212 must be set to 0%. This excludes any negative influences. With PMSM motors, the parameter must be left at the factory setting.</p>			
	<p><b>i</b> <b>Information</b></p> <p><b>U/f – characteristic curve</b></p> <p>For certain applications, particularly those with high centrifugal masses (e.g. fan drives) it may be necessary to control the motor using a U/f characteristic curve. For this, parameters <b>P211</b> and <b>P212</b> must each be set to 0%.</p>			
	<p><b>i</b> <b>Information</b></p> <p><b>PMSM</b></p> <p>When controlling a PMSM, this parameter determines the voltage of the test signal principal (<b>P330</b>). The required voltage depends on various factors (ambient and motor temperature, motor size, motor cable length, size of frequency inverter and others). If the rotor position identification is not successful, this parameter can be used to adjust the voltage.</p>			
<b>P213</b>	<b>ISD ctrl. loop gain</b> ( <i>Amplification of ISD control</i> )		<b>S</b>	<b>P</b>
25 ... 400 % { 100 }	<p>This parameter influences the control dynamics of the FI current vector control (ISD control). Higher settings make the controller faster, lower settings slower.</p> <p>Dependent on application type, this parameter can be altered, e.g. to avoid unstable operation.</p>			
<b>P214</b>	<b>Torque precontrol</b> ( <i>Torque precontrol</i> )		<b>S</b>	<b>P</b>
-200 ... 200 % { 0 }	<p>This function allows a value for the expected torque requirement to be set in the controller. This function can be used in lifting applications for a better load transfer during start-up.</p> <p><b>NOTE:</b> Motor torques (with rotation field right) are entered with a positive sign, generator torques are entered with a negative sign. The reverse applies for the counter clockwise rotation.</p>			

<b>P215</b>	<b>Boost precontrol</b> ( <i>Boost precontrol</i> )		<b>S</b>	<b>P</b>
0 ... 200 % { 0 }	<p>Only advisable with linear characteristic curve (P211 = 0% and P212 = 0%).</p> <p>For drives that require a high starting torque, this parameter provides an option for switching in an additional current during the start phase. The application time is limited and can be selected at parameter &gt;Time boost precontrol&lt; P216.</p> <p>All current and torque current limits that may have been set (P112 and P536, P537) are deactivated during the boost lead time.</p> <p><b>NOTE:</b></p> <p>With active ISD control (P211 and / or P212 ≠ 0%), parameterisation of P215 ≠ 0 results in incorrect control.</p>			
<b>P216</b>	<b>Time boost precontrol</b> ( <i>Time boost precontrol</i> )		<b>S</b>	<b>P</b>
0.0 ... 10.0 sec { 0.0 }	<p>This parameter is used for 3 functionalities</p> <p><b>Time limit for the boost lead:</b> Application time for increased starting current. Only with linear characteristic curve (P211 = 0% and P212 = 0%).</p> <p><b>Time limit for suppression of pulse switch-off (P537):</b> enables start-up under heavy load.</p> <p><b>Time limit for suppression of switch-off on error</b> in parameter (P401), setting { 05 } "0 - 10V with switch-off on error 2"</p>			
<b>P217</b>	<b>Oscillation damping</b> ( <i>Oscillation damping</i> )		<b>S</b>	<b>P</b>
0 ... 400 % { 10 }	<p>With the oscillation damping, idling current harmonics can be damped. Parameter 217 is a measure of the damping power.</p> <p>For oscillation damping the oscillation component is filtered out of the torque current by means of a high pass filter. This is amplified by P217, inverted and switched to the output frequency.</p> <p>The limit for the value switched is also proportional to P217. The time constant for the high pass filter depends on P213. For higher values of P213 the time constant is lower.</p> <p>With a set value of 10 % for P217, a maximum of ± 0.045 Hz are switched in. At 400 % in P217, this corresponds to ± 1.8 Hz</p> <p>The function is not active in "Servo mode, P300".</p>			
<b>P218</b>	<b>Modulation depth</b> ( <i>Modulation depth</i> )		<b>S</b>	
50 ... 110 % { 100 }e	<p>This setting influences the maximum possible output voltage of the FI in relation to the mains voltage. Values &lt;100% reduce the voltage to values below that of the mains voltage if this is required for motors. Values &gt;100% increase the output voltage to the motor increased the harmonics in the current, which may cause swinging in some motors.</p> <p>Normally, 100% should be set.</p>			

<b>P219</b>	<b>Automatic flux optimisation</b> <i>(Automatic flux optimisation)</i>		<b>S</b>	
25 ... 100 % / 101 { 100 }	<p>With this parameter, the magnetic flux of the motor can be automatically matched to the motor load, so that the energy consumption is reduced to the amount which is actually required. P219 is a limiting value, to which the field in the motor can be reduced.</p> <p>As standard, the value is set to 100 %, and therefore no reduction is possible. As minimum, 25 % can be set.</p> <p>The reduction of the field is performed with a time constant of approx. 7.5 s. On increase of load the field is built up again with a time constant of approx. 300 ms. The reduction of the field is carried out so that the magnetisation current and the torque current are approximately equal, so that the motor is operated with "optimum efficiency". An increase of the field above the setpoint value is not intended.</p> <p>This function is intended for applications in which the required torque only changes slowly (e.g. pumps and fans). Its effect therefore replaces a quadratic curve, as it adapts the voltage to the load.</p> <p><b>This parameter does not function for the operation of synchronous motors (IE4 motors).</b></p> <p><b>NOTE:</b> This must not be used for lifting or applications where a more rapid build-up of the torque is required, as otherwise there would be overcurrent switch-offs or inversion of the motor on sudden changes of load, because the missing field would have to be compensated by a disproportionate torque current.</p> <p><b>101 = automatic</b>, with the setting P219 = 101 an automatic magnetisation current controller is activated. The ISD controller then operates with a subordinate magnetizing controller, which improves the slippage calculation, especially at higher loads. The control times are considerably faster compared to the Normal ISD control (P219 = 100)</p>			

---

**P2xx Control/characteristic curve parameters**

---

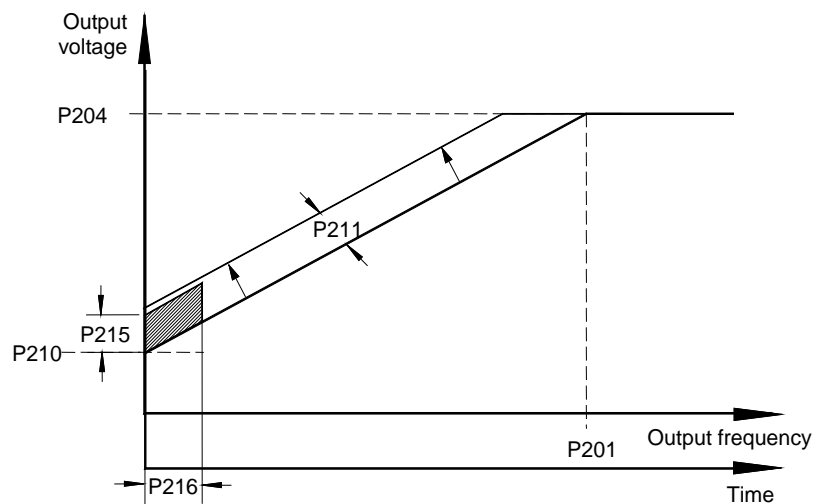

**NOTE:**  
"typical"

Settings for the...

**Current vector control (factory setting)**

- P201 to P209 = Motor data
- P210 = 100%
- P211 = 100%
- P212 = 100%
- P213 = 100%
- P214 = 0%
- P215 = no significance
- P216 = no significance

**Linear V/f characteristic curve**

- P201 to P209 = Motor data
- P210 = 100% (static boost)
- P211 = 0%
- P212 = 0%
- P213 = no significance
- P214 = no significance
- P215 = 0% (boost precontrol)
- P216 = 0s (time dyn. boost)

<b>P220</b>	<b>Para. identification</b> <i>(Parameter identification)</i>			<b>P</b>
0 ... 2 { 0 }	<p>With devices with output of 2.2 KW, the motor data is determined automatically by the device via these parameters. In many cases, better drive behaviour is achieved with the measured motor data.</p> <p>The identification of all parameters takes some time. <b>Do not switch off the mains voltage during this time.</b> If unfavourable operating behaviour takes place after identification, select a suitable motor in P200 or set parameters P201 ... P208 manually.</p> <p><b>0 = No identification</b></p> <p><b>1 = Identification Rs:</b> The stator resistance (display in P208) is determined by multiple measurements.</p> <p><b>2 = Motor identification:</b> This function can only be used with devices up to 2.2 KW. <b>ASM:</b> all motor parameters (P202, P203, P206, P208, P209) are determined. <b>PMSM:</b> the stator resistance (P208) and the inductance (P241) are determined.</p> <p>NB: Motor identification should only be carried out on a cold motor (15 ... 25°C) Warming up of the motor during operation is taken into account.</p> <p>The FI must be in "Ready for operation" condition. For BUS operation, the BUS must be operating without error.</p> <p>The motor power may only be one power level greater or 3 power levels lower than the nominal power of the FI.</p> <p>A maximum motor cable length of 20m must be adhered to for reliable identification.</p> <p>Before starting motor identification, the motor data must be preset in accordance with the rating plate or P200. At least the nominal frequency (P201), the nominal speed (P202), the voltage (P204), the power (P205) and the motor circuit (P207) must be known.</p> <p>Care must be taken that the connection to the motor is not interrupted during the entire measuring process.</p> <p>If the identification cannot be concluded successfully, the error message E019 is generated.</p> <p>After identification of parameters, P220 is again = 0.</p>			

<b>P240</b>	<b>EMF voltage PMSM</b> <i>(EMF voltage PMSM)</i>		<b>S</b>	<b>P</b>										
0 ... 800 V { 0 }	<p>The EMF constant describes the self induction voltage of the motor. The value to be set can be found on the data sheet for the motor or on the type plate and is scaled to 1000 rpm. As the rated speed of the motor is not usually 1000 rpm, these details must be converted accordingly:</p> <p><b>Example:</b></p> <table border="0" style="width: 100%;"> <tr> <td style="width: 50%;">E (EMF - constant, type plate):</td> <td style="width: 50%;">89 V</td> </tr> <tr> <td>Nn (rated speed of motor):</td> <td>2100 rpm</td> </tr> </table> <hr/> <table border="0" style="width: 100%;"> <tr> <td style="width: 50%;">Value in P240</td> <td style="width: 50%;">P240 = E * Nn/1000</td> </tr> <tr> <td></td> <td>P240 = 89 V * 2100 rpm / 1000 rpm</td> </tr> <tr> <td></td> <td><b>P240 = 187 V</b></td> </tr> </table> <p><b>0 = ASM is used, "Asynchronous machine is used":</b> No compensation</p>				E (EMF - constant, type plate):	89 V	Nn (rated speed of motor):	2100 rpm	Value in P240	P240 = E * Nn/1000		P240 = 89 V * 2100 rpm / 1000 rpm		<b>P240 = 187 V</b>
E (EMF - constant, type plate):	89 V													
Nn (rated speed of motor):	2100 rpm													
Value in P240	P240 = E * Nn/1000													
	P240 = 89 V * 2100 rpm / 1000 rpm													
	<b>P240 = 187 V</b>													

<b>P241</b>	[-01] [-02]	<b>Inductivity PMSM</b> <i>(Inductivity PMSM)</i>		<b>S</b>	<b>P</b>
0.1 ... 200.0 mH { all 20.0 }		The typical asymmetric reluctances of the PMSM are compensated with this parameter. The stator inductances can be measured by the frequency inverter (P220)			
		[-01] = d axis ( $L_d$ )	[-02] = q axis ( $L_q$ )		
<b>P243</b>		<b>Reluct. angle IPMSM</b> <i>(Reluctance angle IPMSM)</i>		<b>S</b>	<b>P</b>
0 ... 30 ° { 0 }		In addition to the synchronous torque, synchronous motors with embedded magnets also have a reluctance torque. The reason for this is due to the anisotropy (inequality) between the inductivity in the d and the q direction. Due to the superimposition of these two torque components, the optimum efficiency is not at a load angle of 90°, as with SPMSMs, but rather with larger values. This additional angle, which can be assumed as 10° for NORD motors, can be taken into account with this parameter. The smaller the angle, the smaller the reluctance component.			
		The specific reluctance angle for the motor can be determined as follows:			
		<ul style="list-style-type: none"> <li>• Allow drives with constant load ( &gt; 0.5 M<sub>N</sub>) to run in CFC mode (P300 ≥ 1)</li> <li>• Gradually increase the reluctance angle (P243) until the current (P719) reaches a minimum</li> </ul>			
<b>P244</b>		<b>Peak current PMSM</b> <i>(Peak current PMSM)</i>		<b>S</b>	<b>P</b>
0.1 ... 100.0 A { 5.0 }		This parameter contains the peak current of a synchronous motor. The value must be obtained from the motor data sheet.			
<b>P245</b>		<b>Osc damping .PMSM VFC</b> <i>(Oscillation damping PMSM VFC)</i>		<b>S</b>	<b>P</b>
5 ... 250 % { 25 }		In VFC open-loop mode, PMSM motors tend to oscillate due to insufficient intrinsic damping. With the aid of "oscillation damping" this tendency to oscillate is counteracted by electrical damping.			
<b>P247</b>		<b>Switch freq.VFC PMSM</b> <i>(Switchover frequency VFC PMSM)</i>		<b>S</b>	<b>P</b>
1 ... 100 % { 25 }		In order to provide a minimum amount of torque immediately in case of spontaneous load changes, in VFC mode the setpoint of $I_d$ (magnetisation current) is controlled depending on the frequency (field increase mode) The amount of this additional field current is determined by parameter (P210). This reduces linearly to the value "zero", which is reached at the frequency which is governed by (P247). In this case, 100 % corresponds to the rated motor frequency from (P201).			

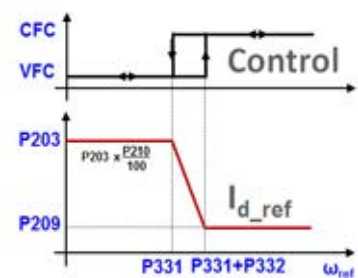

### 5.2.4 Speed control

An incremental rotary encoder does not need to be connected. For this reason, the parameters that are exclusively used to configure a rotary encoder (P301, P312 – P328, P334) are not described in this manual. The parameters concerned are present in the software of the device in spite of this. **It must be ensured that these parameters are always left at the factory settings. Otherwise it cannot be ensured that the frequency inverter will operate correctly.**

However, parameter group **P3xx** is typically concealed in the as-delivered condition of the device, but is visible to NORD CON.

Parameter {factory setting}	Setting value / Description / Note	Device	Supervisor	Parameter set
<b>P300</b>	<b>Servo Mode</b> ( <i>Servo Mode</i> )			<b>P</b>
0 ... 1 { 0 }	<p>The control method for the motor is defined with this parameter.</p> <p><b>0 = Off (VFC open -loop)</b> <sup>1)</sup> Speed control without encoder feedback</p> <p><b>1 = On (CFC closed-loop)</b> <sup>2)</sup> Speed control with encoder feedback</p> <p><b>NOTE:</b> Commissioning information (📖 Abschnitt 4.2.1 "Explanation of the operating modes (P300)").</p> <p>1) Corresponds to the previous setting "OFF"</p> <p>2) Corresponds to the previous setting "ON"</p>			
<p><b>i Information</b> <span style="float: right;"><b>Setting 1 = On (CFC closed loop)</b></span></p> <p>An incremental encoder can be evaluated. For this reason, setting <b>1 = On (CFC closed loop)</b> has no effect.</p>				
<b>P310</b>	<b>Speed controller P</b> ( <i>Speed controller P</i> )			<b>P</b>
0 ... 3200 % { 100 }	<p>P-component of the speed encoder (proportional amplification).</p> <p>Amplification factor, by which the speed difference between the setpoint and actual frequency is multiplied. A value of 100% means that a speed difference of 10% produces a setpoint of 10%. Values that are too high can cause the output speed to oscillate.</p>			
<b>P311</b>	<b>Speed controller I</b> ( <i>Speed controller I</i> )			<b>P</b>
0 ... 800 % / ms { 20 }	<p>I-component of the encoder (Integration component).</p> <p>The integration component of the controller enables the complete elimination of any control deviation. The value indicates how large the setpoint change is per ms. Values that are too small cause the controller to slow down (reset time is too long).</p>			



<b>P312</b>	<b>Torque current controller P</b> <i>(Torque current controller P)</i>		<b>S</b>	<b>P</b>
0 ... 1000 % { 400 }	Current controller for the torque current. The higher the current controller parameters are set, the more precisely the current setpoint is maintained. Excessively high values in P312 generally lead to high-frequency oscillations at low speeds; on the other hand, excessively high values in P313 generally produce low frequency oscillations across the whole speed range.  If the value "Zero" is entered in P312 and P313, then the torque current control is switched off. In this case, only the motor model pre-control is used.			
<b>P313</b>	<b>Torque current controller I</b> <i>(Torque current controller I)</i>		<b>S</b>	<b>P</b>
0 ... 800 % / ms { 50 }	I-proportion of the torque current controller. (See also P312 >Torque current controller P<)			
<b>P314</b>	<b>Torque current controller limit</b> <i>(Torque current controller limit)</i>		<b>S</b>	<b>P</b>
0 ... 400 V { 400 }	Determines the maximum voltage increase of the torque current controller. The higher the value, the greater the maximum effect that can be exercised by the torque current controller. Excessive values in P314 can specifically lead to instability during transition to the field weakening zone (see P320). The values for P314 and P317 should always be set roughly the same, so that the field and torque current controllers are balanced.			
<b>P315</b>	<b>Field current controller P</b> <i>(Field current controller P)</i>		<b>S</b>	<b>P</b>
0 ... 1000 % { 400 }	Current controller for the field current. The higher the current controller parameters are set, the more precisely the current setpoint is maintained. Excessively high values for P315 generally lead to high frequency vibrations at low speeds. On the other hand, excessively high values in P316 generally produce low frequency vibrations across the whole speed range. If the value "Zero" is entered in P315 and P316, then the field current controller is switched off. In this case, only the motor model pre-control is used.			
<b>P316</b>	<b>Field current controller I</b> <i>(Field current controller I)</i>		<b>S</b>	<b>P</b>
0 ... 800 % / ms { 50 }	I-proportion of the field current controller. See also P315 >Field current controller P<			
<b>P317</b>	<b>Field current controller limit</b> <i>(Field current controller limit)</i>		<b>S</b>	<b>P</b>
0 ... 400 V { 400 }	Determines the maximum voltage increase of the field current controller. The higher the value, the greater is the maximum effect that can be exercised by the field current controller. Excessive values in P317 can specifically lead to instability during transition to the field reduction range (see P320). The values for P314 and P317 should always be set roughly the same, so that the field and torque current controllers are balanced.			

<b>P318</b>	<b>Field weakening controller P</b> (Field weakening controller P)		<b>S</b>	<b>P</b>
0 ... 800 % { 150 }	<p>The field weakening controller reduces the field setpoint when the synchronous speed is exceeded. Generally, the field weakening controller has no function; for this reason, the field weakening controller only needs to be set if speeds are set above the nominal motor speed. Excessive values for P318 / P319 will lead to controller oscillations. The field is not weakened sufficiently if the values are too small or during dynamic acceleration and/or delay times. The downstream current controller can no longer read the current setpoint.</p>			
<b>P319</b>	<b>Field weakening controller I</b> (Field weakening controller I)		<b>S</b>	<b>P</b>
0 ... 800 % / ms { 20 }	<p>Only affects the field weakening range, see P318 &gt;Field weakening controller P&lt;</p>			
<b>P320</b>	<b>Field weakening limit</b> (Field weakening limit)		<b>S</b>	<b>P</b>
0 ... 110 % { 100 }	<p>The field weakening limit determines at which speed / current the controller will begin to weaken the field. At a set value of 100% the controller will begin to weaken the field at approximately the synchronous speed.</p> <p>If values much larger than the standard values have been set in P314 and/or P317, then the field weakening limit should be correspondingly reduced, so that the control range is actually available to the current controller.</p>			
<b>P330</b>	<b>Rotor starting position detection</b> (Rotor starting position detection)  (Former designation: "PMSM Regulation ")		<b>S</b>	
0 ... 1 { 0 }	<p>Selection of the method for determination of the starting position of the rotor (initial value of the rotor position) of a PMSM (Permanent Magnet Synchronous Motor).</p> <p>The parameter is only relevant for the control method "CFC closed-loop" (P300, setting "1").</p> <p><b>0 = Voltage controlled:</b> With the first start of the machine, a voltage indicator is memorised which ensures that the rotor of the machine is set to the rotor position "zero". This type of starting position of the rotor can only be used if there is no counter-torque from the machine (e.g. flywheel drive) at frequency "zero". If this condition is fulfilled, this method of determining the position of the rotor is very precise (&lt;1° electrical). In principle, this method is not suitable for lifting equipment, as there is always a counter-torque.</p> <p><u>For operation without encoders, the following applies:</u> Up to the switch over frequency P331 the motor (with the nominal current memorised) is driven under voltage control. Once the switch over frequency has been reached, the method of determining the rotor position is switched over to the EMF method. If, taking hysteresis (P332) into account, the frequency falls below the value in (P331), the frequency inverter switches back from the EMF method to voltage controlled operation.</p> <p><b>1 = Test signal method:</b> The starting position of the rotor is determined with a test signal. This method also functions at a standstill with the brake applied, however it requires a PMSM with sufficient anisotropy between the inductivity of the d and q axes. The higher this anisotropy is, the greater the precision of the method. By means of parameter (P212) the voltage level of the test signal can be adjusted and with parameter (P213) the position of the motor position control can be adjusted. For motors which are suitable for use with the test signal method, a rotor position accuracy of 5°...10° electrical can be achieved (depending on the motor and the anisotropy).</p>			

<b>P350</b>	<b>PLC functionality</b> <i>(PLC functionality)</i>	<b>S</b>
0 ... 1 { 0 }	<p>Activate the integrated PLC</p> <p><b>0 = Off:</b> the PLC is not active, the frequency inverter is actuated in accordance with parameters (P509) and (P510).</p> <p><b>1 = To:</b> the PLC is active, frequency inverter is actuated via the PLC, depending on (P351). The definition of the main setpoints must be carried out accordingly in parameter (P553). Auxiliary setpoints (P510[-02]) can still be defined via (P546).</p>	
<b>P351</b>	<b>PLC Setpoint selection</b> <i>(PLC Setpoint selection)</i>	<b>S</b>
0 ... 3 { 0 }	<p>Selection of the source for the control word (STW) and the main setpoint (HSW) with active PLC functionality (P350 = 1). With the settings "0" and "1", the main setpoints are defined via (P553), but the definition of the auxiliary setpoints remains unchanged via (P546). This parameter is only taken over if the frequency inverter is in "Ready to start" status.</p> <p><b>0 = STW &amp; HSW = PLC:</b> The PLC supplies the control word (STW) and the main setpoint (HSW), and parameters (P509) and (P510[-01]) have no effect.</p> <p><b>1 = STW = P509:</b> The PLC supplies the main setpoint (HSW), the control word (STW) corresponds to the setting in parameter (P509)</p> <p><b>2 = HSW = P510[1]:</b> The PLC supplies the control word (STW), the source for the main setpoint (HSW) corresponds to the setting in parameter (P510[-01])</p> <p><b>3 = STW &amp; HSW = P509/510:</b> The source for the control word (STW) and the main setpoint (HSW) corresponds to the setting in parameter (P509)/(P510[-01])</p>	
<b>P353</b>	<b>Bus status via PLC</b> <i>(Bus status via PLC)</i>	<b>S</b>
0 ... 3 { 0 }	<p>This parameter can be used to determine how the control word (STW) for the master function and the status word (ZSW) of the frequency inverter undergo further processing by the PLC.</p> <p><b>0 = Off:</b> The control word (STW) of the master function (P503≠0) and the status word (ZSW) undergo further processing by the PLC without change.</p> <p><b>1 = STW for broadcast:</b> The control word (STW) for the master value function (P503≠ 0) is set by the PLC. In order to do this, the control word must be redefined in the PLC using process value "34_PLC_Busmaster_Control_word".</p> <p><b>2 = ZSW for bus:</b> The status word (ZSW) of the frequency inverter is set by the PLC. In order to do this, the status word must be redefined in the PLC using process value "28_PLC_status_word".</p> <p><b>3 = STW Broadcast&amp;ZSWBus:</b> See setting 1 and 2</p>	

<b>P355</b> [-01] ... [-10]	<b>PLC Integer Setpoint</b> <i>(PLC Integer Setpoint)</i>		<b>S</b>	
0x0000 ... 0xFFFF all = { 0 }	Data can be exchanged with the PLC via this INT array. This data can be used by the appropriate process variables in the PLC.			
<b>P356</b> [-01] ... [-05]	<b>PLC Long Setpoint</b> <i>(PLC Long Setpoint)</i>		<b>S</b>	
0x0000 0000 ... 0xFFFF FFFF all = { 0 }	Data can be exchanged with the PLC via this DINT array. This data can be used by the appropriate process variables in the PLC.			
<b>P360</b> [-01] ... [-05]	<b>PLC display value</b> <i>(PLC display value)</i>		<b>S</b>	
-2 000 000,000 ... 2 000 000.000 all = { 0.000 }	The parameter is only used to display the PLC Date. Via the corresponding process variables, this parameter can be written by the PLC. The values are not saved!			
<b>P370</b>	<b>PLC Status</b> <i>(PLC Status)</i>		<b>S</b>	
0 ... 63 <sub>dec</sub>  <i>ParameterBox:</i> 0x00 ... 0x3F  <i>SimpleBox / ControlBox:</i> 0x00 ... 0x3F  all = { 0 }	Displays the actual status of the PLC.  <b>Bit 0 = P350=1:</b> Parameter P350 was set in the "Activate internal PLC" function <b>Bit 1 = PLC active:</b> The internal PLC is active. <b>Bit 2 = Stop active:</b> The PLC program is in "Stop" status. <b>Bit 3 = Debug active:</b> The error checking of the PLC program runs. <b>Bit 4 = PLC error:</b> The PLC has an error, but PLC user errors 23.xx are not displayed here. <b>Bit 5 = PLC halted:</b> The PLC program has been halted ( <i>Single Step</i> or <i>Breakpoint</i> ).			

### 5.2.5 Control terminals

Parameter {factory setting}	Setting value / Description / Note		Supervisor	Parameter set
<b>P400</b> [-01] ... [-07]	<b>Function Setpoint inputs</b> (Setpoint inputs function)			<b>P</b>
0 ... 36 { [-01] = 1 } { [-02] = 0 } { [-03] = 0 } { [-04] = 0 } { [-05] = 0 } { [-06] = 0 } { [-07] = 0 }	<p><b>[-01] Analogue input 1</b>, Function of analogue input 1 integrated in the FI</p> <p><b>[-02] Analogue input 2</b>, Function of analogue input 1 integrated in the FI</p> <p><b>[-03] External Analogue input 1</b>, AIN1 of the <u>first</u> I/O extension (SK xU4-IOE)</p> <p><b>[-04] External Analogue input 2</b>, AIN2 of the <u>first</u> I/O extension (SK xU4-IOE)</p> <p><b>[-05] External A.in. 1 2nd IOE</b>, "External analogue input 1 2nd IOE", AIN1 of the <u>second</u> I/O extension (SK xU4-IOE) (= Analogue input 3)</p> <p><b>[-06] External A.in. 2 2nd IOE</b>, "External analogue input 2 2nd IOE", AIN2 of the <u>second</u> I/O extension (SK xU4-IOE) (= Analogue input 4)</p> <p><b>[-07] Setpoint module</b></p>			

... Setting values below.

For standardisation of actual values:  Section 8.9 "Standardisation of setpoint / target values".

- 0 = Off**, the analogue input has no function. After the FI has been enabled via the control terminals, it will supply the set minimum frequency (P104).
- 1 = Setpoint frequency**, the given analogue range (P402/P403) varies the output frequency between the set minimum and maximum frequencies (P104/P105).
- 2 = Frequency addition \*\***, the supplied frequency value is added to the setpoint.
- 3 = Frequency subtraction \*\***, the supplied frequency value is subtracted from the setpoint.
- 4 = Minimum frequency**, setting for minimum frequency of frequency inverter  
Lower limit: 1 Hz  
Standardisation: 0 - 100% of P104
- 5 = Maximum frequency**, setting for maximum frequency of frequency inverter  
Lower limit: 2 Hz  
Standardisation: 0 - 100% of P105
- 6 = Actual value process controller \***, activates the process controller, analogue input is connected to the actual value encoder (compensator, air can, flow volume meter, etc.). The mode is set via the DIP switches of the I/O extension or in (P401).
- 7 = Setpoint process controller \***, as for Function 6, however, the setpoint is specified (e.g. by a potentiometer). The actual value must be specified using another input.
- 8 = Actual PI frequency \***, is required to build up a control loop. The analogue input (actual value) is compared with the setpoint (e.g. fixed frequency). The output frequency is adjusted as far as possible until the actual value equals the setpoint. (see control variables P413...P414)
- 9 = Actual freq. PI limited \***, "Actual frequency PI limited", as for function 8 "Actual frequency PI", however the output frequency cannot fall below the programmed minimum frequency value in Parameter P104. (no change to rotation direction)
- 10 = Actual freq. PID monitored \***, "Actual frequency PID monitored", as for function 8 Actual frequency PI", however the FI switches the output frequency off when the minimum frequency P104 is reached
- 11 = Torque current limit**, "Torque current limited" depends on parameter (P112). This value corresponds to 100% of the setpoint value. When the set limit value is reached, there is a reduction of the output frequency at the torque current limit.
- 12 = Torque current limit switch-off**, "Torque current limit switch-off" depends on parameter (P112). This value corresponds to 100% of the setpoint value. When the set limit value is reached, the device switches off with error code E12.3.

- 13 = Current limit**, "*Current limited*" depends on parameter (P536). This value corresponds to 100% of the setpoint value. When the set limit value is reached, the output voltage is reduced in order to limit the output current.
- 14 = Current switch-off**, "*Current limit switch-off*", depends on parameter (P536), this value corresponds to 100% of the setpoint value. When the set limit value is reached, the device switches off with error code E12.4.
- 15 = Ramp time**, normally only used in combination with a potentiometer.  
Lower limit: 50 ms  
Standardisation:  $T_{\text{Rampenzeit}} = 10s * U[V] / 10V$  (U=Potentiometer voltage)
- 16 = Torque precontrol**, a function that enables a value for the anticipated torque requirement to be entered in the controller (interference factor switching). This function can be used to improve the load take-up of lifting equipment with separate load detection.
- 17 = Multiplication**, the setpoint is multiplied with the analogue value supplied. The analogue value adjusted to 100% then corresponds to a multiplication factor of 1.
- 18 = Curve travel calculator**, via the external analogue input (P400 [-03] or P400 [-04]) or via the BUS (P546 [-01 .. -03]) the master receives the actual speed from the slave. From its own speed, the slave speed and the guide speed, the master calculates the actual setpoint speed, so that neither of the two drives travels faster than the guide speed in the curve.
- 19 = ...reserved**
- 25 = Transfer Factor Gearing**, "*Gearing Transfer Factor*", is a multiplier to compensate for the variable transfer of a setpoint value. E.g.: Setting of the transformation between the master and the slave by means of a potentiometer.
- 26 = ...reserved**
- 30 = Motor temperature**: enables measurement of the motor temperature with a KTY-84 temperature sensor (📖 Section 4.4 "Temperature sensors")
- 33 = Setpoint Torque Proc. cntrl.**, "*Setpoint torque process controller*", for even distribution of the torques to coupled drive units (e.g.: S-roller drive). This function is also possible with the use of ISD control.
- 34 = d-correction F process** - (diameter correction, frequency PI / process controller).
- 35 = d-correction Torque** - (diameter correction, torque).
- 36 = d-correction F + Torque** - (diameter correction, frequency for PI / process controller and torque)

\*) For further details of the PI and process controller, please refer to Section 8.2 "Process controller".

\*\*) The limits of these values are formed by the parameters >minimum frequency auxiliary setpoint values< (P410) and the parameter >maximum frequency auxiliary setpoint values< (P411), whereby the limits defined by (P104) and (P105) cannot be undershot or overshot.

<b>P401</b>	<b>[ -01 ] Analog input mode</b> ... <b>[ -06 ] (Mode analog input)</b>		
-------------	---	--	--

0 ... 5  
{ all 0 }

This parameter determines how the frequency inverter reacts to an analog signal which is less than the 0% adjustment (P402).

- [ -01 ] = Analog input 1:** analog input 1, integrated into the FI
- [ -02 ] = Analog input 2:** analog input 2, integrated into the FI
- [ -03 ] = External analog input 1, "External analog input 1":** Analog input 1 of the first IO extension
- [ -04 ] = External analog input 2, "External analog input 2":** Analog input 2 of the first IO extension
- [ -05 ] = External Analog input 1, 2nd IOE, "External analog input 1 of the 2nd IOE":** Analog input 1 of the second IO extension
- [ -06 ] = External Analog input 2, 2nd IOE, "External analog input 2 of the 2nd IOE":** Analog input 2 of the second IO extension

**0 = 0 – 10V limited:** An analogue setpoint smaller than the programmed adjustment 0% (P402) does not lead to undershooting of the programmed minimum frequency (P104), i.e. it does not result in a change of the direction of rotation.

**1 = 0 – 10V:** If a setpoint smaller than the programmed adjustment 0% (P402) is present, this can cause a change in direction rotation. This allows rotation direction reversal using a simple voltage source and potentiometer.

E.g. internal setpoint with rotation direction change: P402 = 5 V, P104 = 0 Hz, Potentiometer 0-10 V → Rotation direction change at 5 V in mid-range setting of the potentiometer.

At the moment of reversal (hysteresis = ± P505), the drive stands still when the minimum frequency (P104) is smaller than the absolute minimum frequency (P505). A brake that is controlled by the FI will have entered the hysteresis range.

If the minimum frequency (P104) is greater than the absolute minimum frequency (P505), the drive reverses when the minimum frequency is reached. In the hysteresis range ± P104, the FI supplies the minimum frequency (P104), the brake controlled by the FI is not applied.

**2 = 0 – 10V monitored:** If the minimum adjusted setpoint (P402) is undershot by 10% of the difference value from P403 and P402, the FI output switches off. Once the setpoint is greater than  $[P402 - (10\% * (P403 - P402))]$ , it will deliver an output signal again. With the change to firmware version V 1.1 R0 the behaviour of the FI changes in that the function is only active if a function for the relevant input has been selected in P400

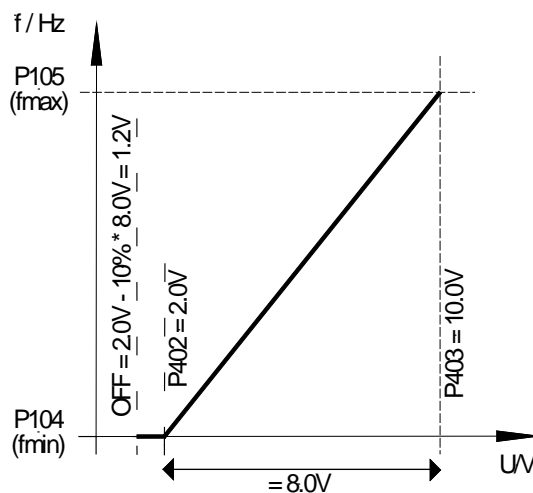

E.g. setpoint 4-20 mA: P402: Adjustment 0 % = 1 V; P403: Adjustment 100 % = 5 V; -10 % corresponds to -0.4 V; i.e. 1...5 V (4...20 mA) normal operating zone, 0.6...1 V = minimum frequency setpoint, below 0.6 V (2.4 mA) output switches off.

---

**3 = - 10V – 10V:** If a setpoint smaller than the programmed adjustment 0% (P402) is present, this can cause a change in direction rotation. This allows rotation direction reversal using a simple voltage source and potentiometer.

E.g. internal setpoint with rotation direction change: P402 = 5 V, P104 = 0 Hz, Potentiometer 0-10 V → Rotation direction change at 5 V in mid-range setting of the potentiometer.

At the moment of reversal (hysteresis =  $\pm$  P505), the drive stands still when the minimum frequency (P104) is smaller than the absolute minimum frequency (P505). A brake that is controlled by the FI will not have entered the hysteresis range.

If the minimum frequency (P104) is greater than the absolute minimum frequency (P505), the drive reverses when the minimum frequency is reached. In the hysteresis range  $\pm$  P104, the FI supplies the minimum frequency (P104), the brake controlled by the FI is not applied.

**NOTE:** The function -10 V – 10 V is a description of the method of function and not a reference to a bipolar signal (see example above).

---

**4 = 0 – 10V with Error 1, "0 – 10V with shut-down on Error 1":**

If the value of the 0% adjustment in (P402) is undershot, the error message 12.8 "Undershoot of Analogue In Min." is activated.

If the value of the 100% adjustment in (P402) is undershot, the error message 12.9 "Undershoot of Analogue In Max." is activated.

Even if the analogue value is outside the limits defined in (P402) and (P403), the setpoint value is limited to 0 - 100%.

The monitoring function only becomes active if an enable signal is present and the analogue value has reached the valid range ( $\geq$ (P402) or  $\leq$ (P403)) for the first time (e.g. pressure build-up after switching on a pump).

*Once the function has been activated, it also operates if the actuation takes place via a field bus, for example, and the analogue input is not actuated at all.*

---

**5 = 0 – 10V m with Error 2, "0 – 10V with switch-off on Error 2":**

See setting 4 ("0 - 10V with error switch off 1"), however:

In this setting the monitoring function only becomes active if an enable signal is present and the time during which the error monitoring is suppressed has elapsed. This suppression time is set in parameter (P216).



P402	[-01] <b>Adjustment: 0%</b> ... [-06] (Analog input adjustment: 0%)		<b>S</b>	
------	---	--	----------	--

-50.00 ... 50.00 V  
{ all 0.00 }

This parameter sets the voltage that should correspond with the minimum value of the selected function for the analog input.

- [ -01 ] = **Analog input 1:** analog input 1, integrated into the FI
- [ -02 ] = **Analog input 2:** analog input 2, integrated into the FI
- [ -03 ] = **External analog input 1,** "External analog input 1": Analog input 1 of the first IO extension
- [ -04 ] = **External analog input 2,** "External analog input 2": Analog input 2 of the first IO extension
- [ -05 ] = **External Analog input 1, 2nd IOE,** "External analog input 1 of the 2nd IOE": Analog input 1 of the second IO extension
- [ -06 ] = **External Analog input 2, 2nd IOE,** "External analog input 2 of the 2nd IOE": Analog input 2 of the second IO extension

Typical setpoints and corresponding settings:

0 – 10 V	→	0.00 V
2 – 10 V	→	2.00 V (monitored for function 0-10 V)
0 – 20 mA	→	0.00 V (internal resistance approx. 250 Ω)
4 – 20 mA	→	1.00 V (internal resistance approx. 250 Ω)

**Note:** *Inner resistance* can be enabled via DIP switch (📖 Section 4.3.2.2 "DIP switches (S1, S2)")

*SK xU4-IOE*

Standardisation to typical signals, such as 0(2)-10V or 0(4)-20mA is carried out via the DIP switch on the I/O-extension module. In this case, additional adjustment of parameters (P402) and (P403) must **not** be carried out.

<b>P403</b>	[-01] <b>Adjustment: 100%</b> ... [-06] (Analog input adjustment: 100%)		<b>S</b>
-------------	---	--	----------

-50.00 ... 50.00 V  
{ all 0.00 }

This parameter sets the voltage that should correspond with the maximum value of the selected function for the analog input.

- [-01] = **Analog input 1**: analog input 1, integrated into the FI
- [-02] = **Analog input 2**: analog input 2, integrated into the FI
- [-03] = **External analog input 1**, "External analog input 1": Analog input 1 of the first IO extension
- [-04] = **External analog input 2**, "External analog input 2": Analog input 2 of the first IO extension
- [-05] = **External Analog input 1, 2nd IOE**, "External analog input 1 of the 2nd IOE": Analog input 1 of the second IO extension
- [-06] = **External Analog input 2, 2nd IOE**, "External analog input 2 of the 2nd IOE": Analog input 2 of the second IO extension

Typical setpoints and corresponding settings:

0 – 10 V	→	10.00 V
2 – 10 V	→	10.00 V (monitored for function 0-10 V)
0 – 20 mA	→	5.00 V (internal resistance approx. 250 Ω)
4 – 20 mA	→	5.00 V (internal resistance approx. 250 Ω)

**Note:** Inner resistance can be enabled via DIP switch (📖 Section 4.3.2.2 "DIP switches (S1, S2)")

*SK xU4-IOE*

Standardisation to typical signals, such as 0(2)-10V or 0(4)-20mA is carried out via the DIP switch on the I/O-extension module. In this case, additional adjustment of parameters (P402) and (P403) must **not** be carried out.

**P400 ... P403**

P401 = 0 → 0 - 10V limited

P401 = 1 → 0 - 10V not limited

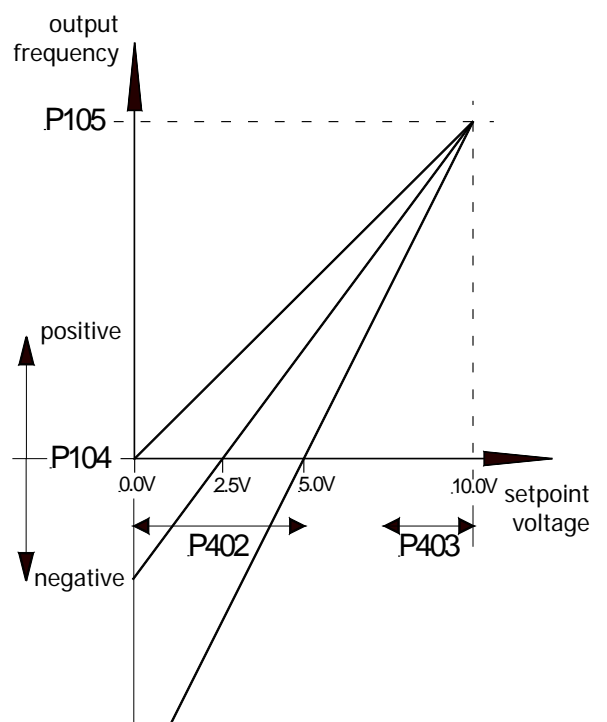
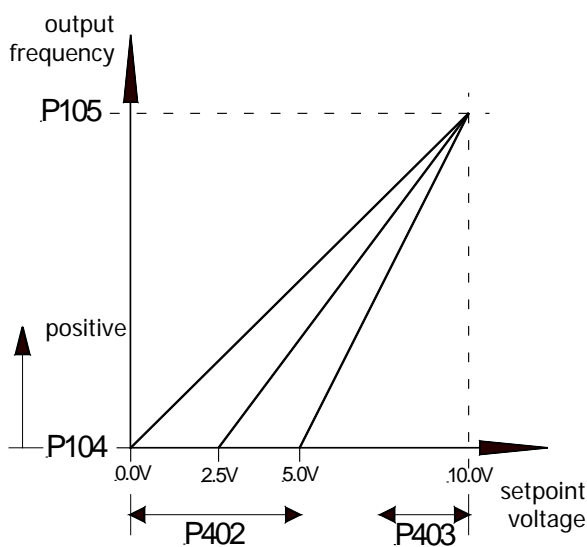

<b>P404</b>	<b>[-01] Analogue input filter</b> <b>[-02] (analogue input filter)</b>		<b>S</b>	
10 ... 400 ms { all 100 }	Adjustable digital low-pass filter for the analogue signal. Interference peaks are hidden, the reaction time is extended.  [-01] = <b>Analogue input 1</b> : analogue input 1 integrated in the device [-02] = <b>Analogue input 2</b> : analogue input 2 integrated in the device  The filter time for the analogue inputs of the optional external IO extension modules is set in the parameter set for the relevant module (P161).			
<b>P410</b>	<b>Min. freq. a-in 1/2</b> (Minimum frequency a-in 1/2 (auxiliary setpoint value))			<b>P</b>
-400.0 ... 400.0 Hz { 0.0 }	The minimum frequency that can act on the setpoint via the auxiliary setpoints. Auxiliary setpoints are all frequencies that are additionally delivered for further functions in the FI: Actual frequency PID      Frequency addition      Frequency subtraction Auxiliary setpoints via BUS      Process controller Min. frequency above analog setpoint (potentiometer)			
<b>P411</b>	<b>Max. freq. a-in 1/2</b> (Maximum frequency a-in 1/2 (auxiliary setpoint value))			<b>P</b>
-400.0 ... 400.0 Hz { 50.0 }	The maximum frequency that can act on the setpoint via the auxiliary setpoints. Auxiliary setpoints are all frequencies that are additionally delivered for further functions in the FI: Actual frequency PID      Frequency addition      Frequency subtraction Auxiliary setpoints via BUS      Process controller Min. frequency above analog setpoint (potentiometer)			
<b>P412</b>	<b>Nom. val. process ctrl.</b> (Nominal value process controller)		<b>S</b>	<b>P</b>
-10.0 ... 10.0 V { 5.0 }	Fixed specification of a setpoint for the process controller that will only occasionally be altered. Only with P400 = 14 ... 16 (process controller) (please see chapter 8.2 "Process controller").			
<b>P413</b>	<b>P-component of PI-controller</b> (P-component PI-controller)		<b>S</b>	<b>P</b>
0.0 ... 400.0 % { 10.0 }	This parameter is only effective when the function PI controller actual frequency is selected. The P-component of the PI controller determines the frequency jump if there is a control deviation based on the control difference. E.g.: At a setting of P413 = 10% and a rule difference of 50%, 5% is added to the actual setpoint.			
<b>P414</b>	<b>I-component PI-controller</b> (I-component of PI-controller)		<b>S</b>	<b>P</b>
0.0 ... 3,000.0 %/s { 10.0 }	This parameter is only effective when the function PI controller actual frequency is selected. The I-component of the PI controller determines the frequency change, dependent on time. <b>Note:</b> In contrast to other NORD series, parameter P414 is smaller by a factor of 100 (Reason: better setting ability with small I-proportions).			
<b>P415</b>	<b>Process controller limit</b> (Control limit of process controller)		<b>S</b>	<b>P</b>
0 ... 400.0 % { 10.0 }	This parameter is only effective when the function <b>PI process controller</b> is selected. This determines the control limit (%) after the PI controller (please see chapter 8.2 "Process controller").			

<b>P416</b>	<b>Ramp time PI setpoint</b> <i>(Ramp time PI setpoint value)</i>		<b>S</b>	<b>P</b>
0.00 ... 99.99 sec { 2.00 }	This parameter is only effective when the function PI process controller is selected. Ramp for PI setpoint			
<b>P417</b> [-01] ... [-02]	<b>Offset analogue output</b> <i>(Offset analogue output)</i>		<b>S</b>	<b>P</b>
-10.0 ... 10.0 V { all 0.0 } only with SK CU4-IOE or SK TU4-IOE	<p>[<b>-01</b>] = <b>First IOE</b>, AOUT of the <u>first</u> I/O extension (SK xU4-IOE)  [<b>-02</b>] = <b>Second IOE</b>, AOUT of the <u>second</u> I/O extension (SK xU4-IOE)</p> <p>In the analogue output function an offset can be entered to simplify the processing of the analogue signal in other equipment.  If the analogue output has been programmed with a digital function, then the difference between the switch-on point and the switch-off point can be set in this parameter (hysteresis).</p>			

P418 [-01] ... [-02]	<b>Analog output func.</b> <i>(Analogue output function)</i>		<b>S</b>	<b>P</b>
0 ... 60 { all 0 }	<p><b>[-01] = IOE-1</b></p> <ul style="list-style-type: none"> <li>• AOUT of first IOE extension (type SK xU4-IOE) or</li> <li>• AOUT1 of I/O extension of type SK xU4-<b>IOE2</b></li> </ul> <hr/> <p><b>[-02] = IOE-2</b></p> <ul style="list-style-type: none"> <li>• AOUT of second IOE extension (type SK xU4-IOE)</li> <li>• AOUT2 of I/O extension of type SK xU4-<b>IOE2</b></li> </ul>			

... only with  
SK CU4-IOE or  
SK TU4-IOE

**Analogue functions** (max. load: 5 mA analogue):

An analogue voltage (0 ... +10 V) can be obtained at the control terminals (max. 5 mA). Various functions are available, where the following basically applies:

- 0 V analogue voltage always corresponds to 0% of the selected value.
- 10 V always corresponds to the nominal motor value (unless otherwise stated) multiplied by the P419 scaling factor, e.g.:

$$\Rightarrow 10 \text{ Volt} = \frac{\text{Nominal motor value} \times \text{P419}}{100\%}$$

With regard to scaling of actual values: (📖 Section 8.9 "Standardisation of setpoint / target values").

- 0 = No function**, no output signal at the terminals
- 1 = Actual frequency\***, the analogue voltage is proportional to the FI output frequency. (100%=(P201))
- 2 = Actual speed\***, synchronous speed calculated by the FI based on the present setpoint. Load-dependent speed fluctuations are not taken into account. If servo mode is used, the measured speed will be output via this function. (100%=(P202))
- 3 = Current\***, effective value of the output current supplied by the FI. (100%=(P203))
- 4 = Torque current\***, displays the motor load torque calculated by the FI. (100% = (P112))
- 5 = Voltage\***, output voltage supplied by the FI. (100%=(P204))
- 6 = D.c. link voltage**, "*Link circuit voltage*", is the DC voltage in the FI. This is not based on the nominal motor data. 10 V with 100% scaling, corresponds to 450 V DC (230 V mains) or 850 V DC (480 V mains)!
- 7 = Value of P542**, the analogue output can be set using parameter P542, irrespective of the actual operating status of the FI. For example, in case of bus control (parameter order), this function may deliver an analogous value from the FI, triggered by the control unit.
- 8 = Apparent power\***, the actual apparent power calculated by the FI. (100%=(P203)\*(P204) or = (P203)\*(P204)\*√3)
- 9 = Real Power\***, actual effective power calculated by the FI. (100%=(P203)\*(P204)\*(P206) or = (P203)\*(P204)\*(P206)\*√3)
- 10 = Torque [%]\***, actual torque calculated by the FI (100% = Nominal motor torque)
- 11 = Field [%]\***, actual field in the motor calculated by the FI.
- 12 = Actual frequency+/-\***, analogue voltage is proportional to the output frequency of the FI, where the zero point has been shifted to 5 V. For CW direction of rotation, values from 5 V to 10 V are output, and for CCW direction of rotation, values from 5 V to 0 V.
- 13 = Speed +/-\***, synchronous speed calculated by the FI, based on the present setpoint, where the zero point has been shifted to 5 V. Values of 5 V to 10 V are output with CW direction of rotation, and values of 5 V to 0 V are output with CCW direction of rotation. If servo mode is used, the measured speed is output via this function.
- 14 = Torque [%]\***, actual torque calculated by the FI, where the zero point has been shifted to 5 V. For motor torques, values between 5 V and 10 V are output, and for generator torques, values between 5 V and 0 V.
- 29 = Reserved**, for POSICON, see [BU0210](#)

- 30 = Set freq. befor ramp**, “Setpoint frequency before ramp”, displays the frequency resulting from any upstream controllers (ISD, PID, ...). This is then the setpoint frequency for the power stage after it has been adjusted via the acceleration or deceleration (P102, P103) ramp.
- 31 = Output via Bus PZD**, the analogue output is controlled via a bus system. The process data is transferred directly (P546="32").
- 33 = Set freq Motorpot**, “Setpoint frequency motor potentiometer”
- 60 = Value of PLC**, the analogue output is set by the integrated PLC, irrespective of the current operating status of the FI.

\*) Values are based on the motor data (P201 ...) or have been calculated from them.

<b>P419</b> [-01] [-02]	<b>Standard Analogue output</b> (Standardisation of analogue output)		<b>S</b>	<b>P</b>
-500 ... 500 % { all 100 }	[-01] = <b>First IOE</b> , AOUT of the <u>first</u> I/O extension (SK xU4-IOE) [-02] = <b>Second IOE</b> , AOUT of the <u>second</u> I/O extension (SK xU4-IOE)			
only with SK CU4-IOE or SK TU4-IOE	Using this parameter an adjustment can be made to the analogue output for the selected operating zone. The maximum analogue output (10 V) corresponds to the standardisation value of the appropriate selection.  If therefore, at a constant working point, this parameter is raised from 100 % to 200 %, the analogue output voltage is halved. 10 Volt output signal then corresponds to twice the nominal value.  For negative values the logic is reversed. An actual value of 0 % will then produce 10 V at the output and -100 % will produce 0 V.			
<b>P420</b> [-01] ... [-05]	<b>Digital inputs</b> (Digital inputs)			
0 ... 80 { [-01] = 1 } { [-02] = 2 } { [-03] = 4 } { [-04] = 0 } { [-05] = 0 }	Up to 3 freely programmable digital inputs are available. The analogue inputs can also still be used as digital inputs, but their electrical characteristics are not compatible with the PLC standard.  [-01] <b>Digital input 1</b> (DIN1), <b>Enable right</b> (default), control terminal 21 [-02] <b>Digital input 2</b> (DIN2), <b>Enable left</b> (default), control terminal 22 [-03] <b>Digital input 3</b> (DIN3), <b>Fixed frequency 1</b> (default), control terminal 23 [-04] <b>Analogue input 1</b> (AIN1/DIN4), <b>no function</b> (default), control terminal 14 [-05] <b>Analogue input 2</b> (AIN2/DIN5), <b>no function</b> (default), control terminal 16  The additional digital inputs of the I/O- extensions (SK xU4-IOE) are administered via the parameter "Bus I/O In Bit (4...7)" - (P480 [-05] ... [-08]) for the <u>first</u> I/O extension, and via the parameter "Bus I/O In Bit (0...3)" - (P480 [-01] ... [-04]) for the <u>second</u> I/O extension.			

### List of possible functions of digital inputs P420

Value	Function	Description	Signal
<b>00</b>	No function	Input switched off.	---
<b>01</b>	Enable right	The FI delivers an output signal with the rotation field right if a positive setpoint is present: 0 → 1 Flank (P428 = 0)	High
<b>02</b>	Enable left	The FI delivers an output signal with the rotation field left if a positive setpoint is present: 0 → 1 Flank (P428 = 0)	High
<p>If the drive is to start up automatically when the mains is switched on (P428 = 1) a permanent High level for enabling must be provided (supply terminal 21 with 24V).</p> <p>If the functions "Enable right" and "Enable left" are actuated simultaneously, the FI is blocked.</p> <p>If the frequency inverter is in fault status but the cause of the fault no longer exists, the error message is acknowledged with a <b>1 → 0 flank</b>.</p>			
<b>03</b>	Change of rotation direction	Causes the rotation field to change direction in combination with Enable right or left.	High

Value	Function	Description	Signal
04 <sup>1</sup>	Fixed frequency 1	The frequency from P465 [01] is added to the actual setpoint value.	High
05 <sup>1</sup>	Fixed frequency 2	The frequency from P465 [02] is added to the actual setpoint value.	High
06 <sup>1</sup>	Fixed frequency 3	The frequency from P465 [03] is added to the actual setpoint value.	High
07 <sup>1</sup>	Fixed frequency 4	The frequency from P465 [04] is added to the actual setpoint value.	High
If several fixed frequencies are actuated at the same time, then they are added with the correct sign. The analogue setpoint (P400) and, if necessary, the minimum frequency (P104) are also added.			
08 <sup>4</sup>	Parameter set changeover "Parameter set changeover 1"	Selection of active parameter set 1...4 - first bit.	High
09	Hold frequency	During the acceleration or deceleration phase, a Low level will cause the actual output frequency to "Halt". A High level allows the ramp to continue.	Low
10 <sup>2</sup>	Disable voltage ( <b>coast to stop</b> )	The FI output voltage is switched off; the motor runs down freely.	Low
11 <sup>2</sup>	Quick stop	The FI reduces the frequency according to the programmed quick stop time P426.	Low
12 <sup>2</sup>	Fault acknowledgement	Fault acknowledgement with an external signal. If this function is not programmed, a fault can also be acknowledged by a low enable setting (P506).	0→1 Flank
13 <sup>2</sup>	PTC resistor input	Only with the use of a temperature monitor (bimetallic switching contact). Switch-off delay = 2sec, warning after 1 sec.	High
14 <sup>2,3</sup>	Remote control	With bus system control, Low level switches the control to control via control terminals.	High
15	Jog frequency <sup>1</sup>	The frequency value from (P113) can also be set directly using the HIGHER/LOWER buttons with a controller, SimpleBox or ParameterBox and stored in (P113) using the OK button. If the device is operating with inching frequency, any bus actuation that may be active is deactivated.	High
16	Motor potentiometer	Similar to 09, but the frequency is not maintained below the minimum frequency P104 and above the maximum frequency P105.	Low
17 <sup>4</sup>	ParaSet Switching 2 "Parameter set changeover 2"	Selection of active parameter set 1...4 - second bit.	High
18 <sup>2</sup>	Watchdog	Input must see a High flank cyclically (P460), otherwise error E012 will cause a shutdown. Function starts with the 1st high flank.	0→1 Flank
19	Setpoint 1 on/off	Analogue input switch-on and switch-off 1/2 (high = ON) <u>of the first I/O extension</u> . The Low signal sets the analogue input to 0 % which does not lead to shutdown when the minimum frequency (P104) > than the absolute minimum frequency (P505).	High
20	Setpoint 2 on/off		High
21	... 28 reserved		
29	Enable SetpointBox	The release signal is provided by the <i>Simple SetpointBox</i> (setpoint box) SK SSX-3A, whereby the Box must be operated in <b>IO-S</b> mode. → <a href="#">BU0040</a>	High
30	Disable PID	Switching the PID controller / process controller function on and off (high = ON)	High
31 <sup>2</sup>	Disable right rotation	Blocks the >Enable right/left< via a digital Input or bus actuation. Does not depend on the actual direction of rotation of the motor (e.g. following negated setpoint).	Low
32 <sup>2</sup>	Disable left rotation		Low

Value	Function	Description	Signal
33	... 43 reserved		
44	3-wire direction "3-wire control direction change" (normally open button)		0→1 Flank
45	3-W-Ctrl. Start-Right "3-wire control start right" (normally open button)	This control function provides an alternative to enable R/L (01/02), in which a permanently applied level (maintained signal) is required.	0→1 Flank
46	3-W-Ctrl Start-Left "3-Wire-Control Start-Left" (normally open button)	Here, only a control impulse is required to trigger the function. The control of the FI can therefore be performed entirely with pushbuttons.	0→1 Flank
49	3-Wire-Ctrl. Stop "3-Wire-Control Stop" (normally closed button)		1→0 Flank
47	Motorpot. Freq. + "Motor potentiometer frequency +"	In combination with enable R/L the output frequency can be continuously varied. To save a current value in P113, both inputs must be at a High voltage for 0.5s. This value then applies as the next starting value for the same direction of rotation (Enable R/L)	High
48	Motorpot. Freq. - "Motor potentiometer frequency -"	otherwise start at $f_{MIN}$ .	High
50	Bit 0 fixed frequency array		High
51	Bit 1 fixed frequency array	Binary coded digital inputs to generate up to 15 fixed frequencies.	High
52	Bit 2 fixed frequency array	(P465: [-01] ... [-15])	High
53	Bit 3 fixed frequency array		High
55	... 64 Reserved		
65 <sup>2</sup>	Man/auto brake release "Release brake manually / automatically"	The brake is automatically released by the frequency inverter (automatic brake control) if this digital input has been set.	High
66 <sup>2</sup>	Release brake manually "Release brake manually"	The brake is only released if the digital input is set.	High
67	Man/auto set dig. out. "Set digital output manually/automatically"	Set digital output 1 manually, or via the function set in (P434)	High
68	Digit. out. man. Set "Set digital output manually"	Set digital output 1 manually	High
69	Speed meas. with ini. "Speed measurement with initiator"	Simple speed measurement (impulse measurement) with initiator	Impulse
70	Reserved		
71	Motorpot.F+ and Save "Motor potentiometer function frequency + with automatic saving"	This "motor potentiometer function" is used to set a setpoint (amount) via the dig. inputs that is saved at the same time. With control enabling R/L this is then started up in the correspondingly enabled direction. On change of direction the frequency is retained.  Simultaneous activation of the +/- function causes the frequency setpoint value to be set to zero.	High
72	Motorpot.F- and Save "Motor potentiometer function Frequency - with automatic saving"	The frequency setpoint can also be set in the operating value display (P001=30, Actual. setpoint MP-S) or displayed or set in P718.  Any minimum frequency set (P104) is still effective. Other setpoint values, e.g. analogue or fixed frequencies can be added or subtracted.  The adjustment of the frequency setpoint value is performed with the ramps from P102/103.	High



Value	Function	Description	Signal															
73 <sup>2</sup>	Clockw. disable + fast "Disable clockwise rotation + Fast Stop"	As for setting 31, however coupled to the function "Fast Stop".	Low															
74 <sup>2</sup>	Anticlockw. disable + fast "Disable anticlockwise rotation + Fast Stop"	As for setting 32, however coupled to the function "Fast Stop".	Low															
75	D. out. 2 man/ auto set "Set digital output manually/automatically"	2 As for function 67, however for digital output 2 (only SK 2x0E)	High															
76	D. out. 2 man. set "Set digital output 2 manually"	As for function 68, however for digital output 2 (only SK 2x0E)	High															
77	...79 reserved																	
80	PLC - Stop	The program execution of the integrated PLC is stopped for as long as the signal is present.	High															
1	If no digital input is programmed for "Right enable" or "Left enable", the actuation of a fixed frequency or the jog frequency will enable the frequency inverter. The rotation field direction depends on the sign of the setpoint.																	
2	Also effective for BUS control (e.g. RS232, RS485, CANopen, AS-Interface, ...)																	
3	Function cannot be selected via BUS IO In Bits																	
4	The operating parameter set is selected using appropriately parametrised digital inputs or by means of BUS actuation. Switching can take place during operation (online). Coding takes place in binary in accordance with the adjacent sample. If enabled via the keyboard (SimpleBox, ControlBox, PotentiometerBox or ParameterBox), the operating parameter set will match the settings in P100.																	
			<table border="1"> <thead> <tr> <th>Setting</th> <th>Digital input function [8]</th> <th>Digital input function [17]</th> </tr> </thead> <tbody> <tr> <td>0 = Parameter set 1</td> <td>LOW</td> <td>LOW</td> </tr> <tr> <td>1 = Parameter set 2</td> <td>HIGH</td> <td>LOW</td> </tr> <tr> <td>2 = Parameter set 3</td> <td>LOW</td> <td>HIGH</td> </tr> <tr> <td>3 = Parameter set 4</td> <td>HIGH</td> <td>HIGH</td> </tr> </tbody> </table>	Setting	Digital input function [8]	Digital input function [17]	0 = Parameter set 1	LOW	LOW	1 = Parameter set 2	HIGH	LOW	2 = Parameter set 3	LOW	HIGH	3 = Parameter set 4	HIGH	HIGH
Setting	Digital input function [8]	Digital input function [17]																
0 = Parameter set 1	LOW	LOW																
1 = Parameter set 2	HIGH	LOW																
2 = Parameter set 3	LOW	HIGH																
3 = Parameter set 4	HIGH	HIGH																

<b>P426</b>	<b>Quick stop time</b> (Quick stop time)		<b>S</b>	<b>P</b>
0 ... 320.00 sec { 0.10 }	Setting of the stop time for the fast stop function which can be triggered either via a digital input, the bus control, the keyboard or automatically in case of a fault.  Emergency stop time is the time for the linear frequency decrease from the set maximum frequency (P105) to 0Hz. If an actual setpoint <100% is being used, the emergency stop time is reduced correspondingly.			
<b>P427</b>	<b>Quick stop on error</b> (Quick stop on error)		<b>S</b>	
0 ... 3 { 0 }	Activation of automatic emergency stop following error <b>0 = OFF:</b> Automatic emergency stop following error is deactivated <b>1 = Mains supply failure:</b> Automatic emergency stop following mains supply failure <b>2 = In case of faults:</b> Automatic emergency stop following fault <b>3 = Fault or mains failure:</b> Automatic emergency stop in case of fault or mains failure An emergency stop can be triggered by the errors <b>E2.x</b> , <b>E7.0</b> , <b>E10.x</b> , <b>E12.8</b> , <b>E12.9</b> and <b>E19.0</b> .			

<b>P428</b>	<b>Automatic start</b> (Automatic start)		<b>S</b>	<b>P</b>
0 ... 1 { 0 }	<p>In the standard setting (P428 = 0 → <b>Off</b>) the inverter requires a flank to enable (signal change from "low → high") at the relevant digital input.</p> <p>In the setting <b>On</b> → 1 the FI reacts to a High level. This function is only possible if the FI is controlled using the digital inputs. (see P509=0/1)</p> <p>In certain cases, the FI must start up directly when the mains are switched on. For this P428 = 1 → <b>On</b> can be set. If the enable signal is permanently switched on, or equipped with a cable jumper, the FI starts up immediately.</p> <p><b>NOTE:</b> (P428) not "ON" if (P506) = 6, <b>Danger!</b> (See note on (P506))</p> <p><b>NOTE:</b> The "Automatic Start" function can only be used if a digital input of the <u>frequency inverter</u> (DIN 1 ...) is parameterised to the function "Enable Right" or "Enable Left" and this input is permanently set to "High". The digital inputs of the technology modules (e.g.: SK CU4 - IOE) do not support this "Automatic Start" function!</p> <p><b>NOTE:</b> The "Automatic Start" function can only be activated if the frequency inverter has been parameterised to local control ((P509) setting { 0 } or { 1 } ).</p>			

<b>P434</b> [-01] [-02]	<b>Digital out function</b> (Digital output function)			
----------------------------	--	--	--	--

0 ... 40  
{ [-01] = 7 }  
{ [-02] = 1 }

**[-01] = Digital output 1**, Digital output 1 of the frequency inverter  
**[-02] = Digital output 2**, Digital output 2 of the frequency inverter

Settings 3 to 5 and 11 work with 10% hysteresis, i.e. the output delivers (function 11 does not deliver) on reaching the 24 V limit and switches this off again when the value drops to a value that is 10% lower (function 11 on again).  
This behaviour can be inverted with a negative value in P435.

Setting/function	Output ... with limit or function (See also P435)
<b>0 = No function</b>	Low
<b>1 = External brake</b> , to control an external 24 V brake relay (max. 20 mA). The output switches at a programmed absolute minimum frequency (P505). For typical brakes, a setpoint delay of 0.2-0.3 s (see also P107/P114) should be programmed.	Low
<b>2 = Inverter is working</b> , the output indicates voltage at the output (U - V - W).	High
<b>3 = Current limit</b> , based on the setting of the nominal current (P203). This value can be adjusted via scaling (P435).	High
<b>4 = Torque current limit</b> : based on motor data settings in P203 and P206. Signals a corresponding torque load on the motor. This value can be adjusted via scaling (P435).	High
<b>5 = Frequency limit</b> , based on nominal frequency setting in P201. This value can be adjusted via scaling (P435).	High
<b>6 = Level with setpoint</b> , indicates that the FI has completed the frequency increase or decrease. Setpoint frequency = Actual frequency! From a difference of 1 Hz → Setpoint not reached – Signal low.	High
<b>7 = Fault</b> , general fault message, fault is active or not yet acknowledged. → Fault - Low (Ready for operation - High)	Low
<b>8 = Warning</b> , general warning, a limit was reached that could lead to a later switch-off of the FI.	Low
<b>9 = Overcurrent warning</b> , at least 130% of the nominal FI current was supplied for 30 seconds.	Low

<b>10 = Mot. overtemp. warning</b> , "Motor overtemperature warning" The motor temperature is evaluated. → Motor is too hot. The warning is given immediately, overtemperature switch-off after 2 seconds.	Low
<b>11 = Torque current limit</b> , "Torque current limit/current limit active warning": The limit value in P112 or P536 has been reached. A negative value in P435 inverts the behaviour. Hysteresis = 10 %.	Low
<b>12 = Value of P541</b> , "Value of P541 – external control", the output can be controlled with parameter P541 (Bit 0) independent of the actual operating status of the FI.	High
<b>13 = Torq.curr. limit gen</b> , "Generated torque current limit active": Limit value in P112 was reached in the generator range. Hysteresis = 10 %	High
<b>16 = Comparison val. AIN1</b> , Setpoint AIN1 of the FI is compared with the value in (P435[-01 or -02]).	High
<b>17 = Comparison val. AIN2</b> , Setpoint AIN2 of the FI is compared with the value in (P435[-01 or -02]).	High
<b>18 = Inverter ready</b> : The FI is ready for operation. After being enabled, it delivers an output signal.	High
<b>19 = ... 29 reserved</b>	
<b>30 = Status dig in 1</b>	High
<b>31 = Status dig in 2</b>	High
<b>32 = Status dig in 3</b>	High
<b>33 = Status dig in 4 / AIN1</b>	High
<b>34 = Status dig in 5 / AIN2</b>	High
<b>38 = Value Bus Setpoint</b>	High
<b>39 = STO inactive</b>	High
<b>40 = Output via PLC</b> , the output is set by the integrated PLC	High

<b>P435</b>	<b>[-01] Dig. out scaling</b>		
	<b>[-02] (Scaling of digital output)</b>		

-400 ... 400 %  
{ 100 }

**[-01] = Digital output 1**, Digital output 1 of the frequency inverter  
**[-02] = Digital output 2**, Digital output 2 of the frequency inverter

Adjustment of the limiting values of the output function. For a negative value, the output function will be output negative.

Reference to the following values:

Current limit (3) = x [%] · P203 >Rated motor current<

Torque current limit (4) = x [%] · P203 · P206 (calculated rated motor torque)

Frequency limit (5) = x [%] · P201 >Rated motor frequency<

<b>P436</b>	<b>[-01] Dig. out. hysteresis</b> <b>[-02] (Hysteresis of digital outputs)</b>		<b>S</b>	
1 ... 100 % { 10 }	<p><b>[-01] = Digital output 1</b>, Digital output 1 of the frequency inverter</p> <p><b>[-02] = Digital output 2</b>, Digital output 2 of the frequency inverter</p> <p>Difference between switch-on and switch-off point to prevent oscillation of the output signal.</p>			
<b>P460</b>	<b>Time Watchdog</b> <i>(Time Watchdog)</i>		<b>S</b>	
-250.0 ... 250.0 sec { 10.0 }	<p><b>0.1 ... 250.0</b> = The time interval between the expected Watchdog signals (programmable function of the digital inputs P420...). If this time interval elapses without a pulse being registered, switch off and error message E012 are actuated.</p> <p><b>0.0 = customer error:</b> As soon as a high-low flank or a low signal is detected at a digital input (function 18) the FI switches off with error message E012.</p> <p><b>-250.0 ... -0.1 = Rotor running watchdog:</b> In this setting the rotor running watchdog is active. The time is defined by the number of the value which has been set. When the FI is switched off, there is no watchdog message. After each enable, a pulse must first be received before the watchdog is activated.</p>			
<b>P464</b>	<b>Fixed frequencies mode</b> <i>(Fixed frequencies mode)</i>		<b>S</b>	
0 ... 1 { 0 }	<p>This parameter determines the form in which fixed frequencies are to be processed.</p> <p><b>0 = Addition to main setpoint:</b> Fixed frequencies and the fixed frequency array are added to each other. I.e. they are added together, or added to an analog setpoint to which limits are assigned according to P104 and P105.</p> <p><b>1 = Main setpoint:</b> Fixed frequencies are not added - neither together, nor to analog setpoints. If for example, a fixed frequency is switched to an existing analog setpoint, the analog setpoint will no longer be considered. Programmed frequency addition or subtraction with an analog input value or a bus setpoint is still possible and valid, as is the addition to the setpoint of a motor potentiometer function (function of digital inputs: 71/72). If several fixed frequencies are selected simultaneously, the frequency with the highest value has priority (E.g.: <math>20 &gt; 10</math> or <math>20 &gt; -30</math>).</p> <p><b>Note:</b> The highest active fixed frequency is added to the setpoint value of the motor potentiometer if the functions 71 or 72 are selected for 2 digital inputs.</p>			

<b>P465</b>	<b>[ -01 ] Fixed frequency field</b> ... <b>[ -15 ]</b> <i>(Fixed frequency / Frequency array)</i>			
-400.0 ... 400.0 Hz { [-01] = 5.0 } { [-02] = 10.0 } { [-03] = 20.0 } { [-04] = 35.0 } { [-05] = 50.0 } { [-06] = 70.0 } { [-07] = 100.0 } { [-08] = 0.0 } { [-09] = -5.0 } { [-10] = -10.0 } { [-11] = -20.0 } { [-12] = -35.0 } { [-13] = -50.0 } { [-14] = -70.0 } { [-15] = -100.0 }	In the array levels, up to 15 different fixed frequencies can be set, which in turn can be encoded for the functions 50...54 in binary code for the digital inputs.	<b>[ -01 ]</b> = Fixed frequency 1 / Array 1 <b>[ -02 ]</b> = Fixed frequency 2 / Array 2 <b>[ -03 ]</b> = Fixed frequency 3 / Array 3 <b>[ -04 ]</b> = Fixed frequency 4 / Array 4 <b>[ -05 ]</b> = Fixed frequency / Array 5 <b>[ -06 ]</b> = Fixed frequency / Array 6 <b>[ -07 ]</b> = Fixed frequency / Array 7 <b>[ -08 ]</b> = Fixed frequency / Array 8	<b>[ -09 ]</b> = Fixed frequency / Array 9 <b>[ -10 ]</b> = Fixed frequency / Array 10 <b>[ -11 ]</b> = Fixed frequency / Array 11 <b>[ -12 ]</b> = Fixed frequency / Array 12 <b>[ -13 ]</b> = Fixed frequency / Array 13 <b>[ -14 ]</b> = Fixed frequency / Array 14 <b>[ -15 ]</b> = Fixed frequency / Array 15	
<b>P466</b>	<b>Min.freq. process cont.</b> <i>(Minimum frequency process controller)</i>		<b>S</b>	<b>P</b>
0.0 ... 400.0 Hz { 0.0 }	With the aid of the minimum frequency process controller the control ratio can also be kept to a minimum ratio, even with a master value of "zero", in order to enable adjustment of the compensator. More details can be found in P400 and (chapter 8.2).			
<b>P475</b>	<b>[ -01 ] delay on/off switch</b> ... <b>[ -05 ]</b> <i>(Digital function switch on/off delay)</i>		<b>S</b>	
-30,000 ... 30,000 sec { 0,000 }	Adjustable switch-on/off delay for the digital inputs and the digital functions of the analogue inputs. Use as a switch-on filter or simple process control is possible.	<b>[ -01 ]</b> = Digital input 1 <b>[ -02 ]</b> = Digital input 2 <b>[ -03 ]</b> = Digital input 3 <b>[ -04 ]</b> = Digital input 4 / AIN1 <b>[ -05 ]</b> = Digital input 5 / AIN2	<b>Positive values</b> = switch-on delayed <b>Negative values</b> = switch-off delayed	

<b>P480</b>	<b>[-01]</b> ... <b>[-12]</b>	<b>Function BusIO In Bits</b> <i>(Bus I/O In Bits function)</i>		
0 ... 80 { [-01] = 01 } { [-02] = 02 } { [-03] = 05 } { [-04] = 12 } { [-05...-12] = 00 }		<p>The Bus I/O In Bits are perceived as digital inputs. They can be set to the same functions (P420). With devices with an integrated AS interface, the I/O bits can be used by the interface itself (bit 0 ... 3) or in combination with I/O extensions (SK xU4-IOE) (bits 4 ... 7 and bits 0 ... 3). <i>With AS-i devices, the priority is AS-i. In this case BUS IO BITS 1 ... 4 cannot be used by the 2nd. IO extension.</i></p> <p><b>[-01] = Bus / AS-i Dig In1</b> (Bus IO In Bit 0 + AS-i 1 or DI 1 of the <b>second</b> SK xU4-IOE (DigIn 09))  <b>[-02] = Bus / AS-i Dig In2</b> (Bus IO In Bit 1 + AS-i 2 or DI 2 of the <b>second</b> SK xU4-IOE (DigIn 10))  <b>[-03] = Bus / AS-i Dig In3</b> (Bus IO In Bit 2 + AS-i 3 or DI 3 of the <b>second</b> SK xU4-IOE (DigIn 11))  <b>[-04] = Bus / AS-i Dig In4</b> (Bus IO In Bit 3 + AS-i 4 or. DI 4 of the <b>second</b> SK xU4-IOE (DigIn 12))  <b>[-05] = Bus / IOE Dig In1</b> (Bus IO In Bit 4 + DI 1 of the <b>first</b> SK xU4-IOE (DigIn 05))  <b>[-06] = Bus / IOE Dig In2</b> (Bus IO In Bit 5 + DI 2 of the <b>first</b> SK xU4-IOE (DigIn 06))  <b>[-07] = Bus / IOE Dig In3</b> (Bus IO In Bit 6 + DI 3 of the <b>first</b> SK xU4-IOE (DigIn 07))  <b>[-08] = Bus / IOE Dig In4</b> (Bus IO In Bit 7 + DI 4 of the <b>first</b> SK xU4-IOE (DigIn 08))  <b>[-09] = Flag 1</b> <sup>1)</sup>  <b>[-10] = Flag 2</b> <sup>1)</sup>  <b>[-11] = Bit 8 BUS control word</b>  <b>[-12] = Bit 9 BUS control word</b></p> <p>The possible functions for the bus In bits can be found in the table of functions for the digital inputs in parameter (P420). Functions {14} "Remote control" and {29} "Enable SetpointBox" are not possible.</p>		

1) The flag function is only possible with control via control terminals.

<b>P481</b>	<b>[-01]</b> ... <b>[-10]</b>	<b>Function BusIO Out Bits</b> <i>(Function of Bus I/O Out Bits)</i>		
0 ... 40 { [-01] = 18 } { [-02] = 08 } { [-03] = 30 } { [-04] = 31 } { [-05...-10] = 00 }		<p>The bus I/O Out bits are perceived as multi-function relay outputs. They can be set to the same functions (P434). With devices with in integrated AS interface, the I/O bits can be used by the interface itself (bit 0 ... 3) or in combination with I/O extensions (SK xU4-IOE) (bits 4 ... 5 and flags 1 ... 2).</p> <p><b>[-01] = Bus / AS-i Dig Out1</b> (Bus IO Out Bit 0 + AS-i 1)  <b>[-02] = Bus / AS-i Dig Out2</b> (Bus IO Out Bit 1 + AS-i 2)  <b>[-03] = Bus / AS-i Dig Out3</b> (Bus IO Out Bit 2 + AS-i 3)  <b>[-04] = Bus / AS-i Dig Out4</b> (Bus IO Out Bit 3 + AS-i 4)  <b>[-05] = Bus / IOE Dig Out1</b> (Bus IO Out Bit 4 + DO 1 of the <b>first</b> SK xU4-IOE (DigOut 02))  <b>[-06] = Bus / IOE Dig Out2</b> (Bus IO Out Bit 5 + DO 2 of the <b>first</b> SK xU4-IOE (DigOut 03))  <b>[-07] = Bus / 2nd IOE Dig Out1</b> (Flag1 <sup>1)</sup> + DO 1 of the <b>second</b> SK xU4-IOE (DigOut 04))  <b>[-08] = Bus / 2nd IOE Dig Out2</b> (Flag2 <sup>1)</sup> + DO 2 of the <b>second</b> SK xU4-IOE (DigOut 05))  <b>[-09] = Bit 10 BUS status word</b>  <b>[-10] = Bit 13 BUS status word</b></p> <p>The possible functions for the Bus Out Bits can be found in the table of functions for the digital outputs (P434).</p>		

1) The flag function is only possible with control via control terminals.

### P480 ... P481 Use of the marker

With the aid of the marker it is possible to define simple logical sequences of functions. For this, the "trigger" of a function is defined in the arrays [-09] "Flag 1" and [-10] "Flag 2" (e.g. an overtemperature warning from the motor PTC)

In arrays [-11] and [-12] of parameter P480, the function which the frequency inverter is to perform if the "trigger" is active is assigned in arrays [-11] and [-12] of parameter P480. I.e. parameter P480 determines the response of the frequency inverter.

*Example:*

In an application, the frequency inverter is to reduce the actual speed immediately (e.g. with an active fixed frequency) if the motor is in the overtemperature range ("Overtemp. motor PTC"). This is to be implemented by "Deactivation of analog input 1" via the setpoint used in this example.

This is to ensure that the load on the motor drops and the temperature can stabilise again, and that the drive systematically reduces its speed to a defined amount before a fault shutdown occurs.

Step	Description	Function
1	Specify trigger Set Flag 1 to function "Motor overtemperature warning"	P481 [-07] → Function "12"
2	Specify the response Set Flag 1 to the function "Setpoint 1 on/off"	P480 [-09] → Function "19"

Depending on the function selected in (P481) the function must be inverted by adjusting the scaling (P482).

<b>P482</b>	<b>[-01] Standard BusIO Out Bits</b> ... <b>[-10] (Standardisation of Bus I/O Out Bits)</b>		<b>S</b>	
-------------	---	--	----------	--

-400 ... 400 % { all 100 }	Adjustment of the limit values of the bus Out bits. For a negative value, the output function will be output negative. Once the limit value is reached and positive values are delivered, the output produces a High signal, for negative setting values a Low signal.
<b>[-01] = Bus / AS-i Dig Out1</b>	(Bus IO Out Bit 0 + AS-i 1)
<b>[-02] = Bus / AS-i Dig Out2</b>	(Bus IO Out Bit 1 + AS-i 2)
<b>[-03] = Bus / AS-i Dig Out3</b>	(Bus IO Out Bit 2 + AS-i 3)
<b>[-04] = Bus / AS-i Dig Out4</b>	(Bus IO Out Bit 3 + AS-i 4)
<b>[-05] = Bus / IOE Dig Out1</b>	<b>(Bus IO Out Bit 4 + DO 1 of the first SK xU4-IOE (DigOut 02))</b>
<b>[-06] = Bus / IOE Dig Out2</b>	<b>(Bus IO Out Bit 5 + DO 2 of the first SK xU4-IOE (DigOut 03))</b>
<b>[-07] = Bus / 2nd IOE Dig Out1</b>	<b>(Flag1 + DO 1 of the second SK xU4-IOE (DigOut 04))</b>
<b>[-08] = Bus / 2nd IOE Dig Out2</b>	<b>(Flag2 + DO 2 of the second SK xU4-IOE (DigOut 05))</b>
<b>[-09] = Bit 10 BUS status word</b>	
<b>[-10] = Bit 13 BUS status word</b>	

<b>P483</b>	<b>[ -01 ] Hyst. BusIO Out Bits</b> ... <b>[ -10 ]</b> ( <i>Hysteresis of Bus I/O Out Bits</i> )		<b>S</b>	
1 ... 100 % { all 10 }	Difference between switch-on and switch-off point to prevent oscillation of the output signal.			
	<b>[ -01 ] = Bus / AS-i Dig Out1</b>	(Bus IO Out Bit 0 + AS-i 1)		
	<b>[ -02 ] = Bus / AS-i Dig Out2</b>	(Bus IO Out Bit 1 + AS-i 2)		
	<b>[ -03 ] = Bus / AS-i Dig Out3</b>	(Bus IO Out Bit 2 + AS-i 3)		
	<b>[ -04 ] = Bus / AS-i Dig Out4</b>	(Bus IO Out Bit 3 + AS-i 4)		
	<b>[ -05 ] = Bus / IOE Dig Out1</b>	<b>(Bus IO Out Bit 4 + DO 1 of the first SK xU4-IOE (DigOut 02))</b>		
	<b>[ -06 ] = Bus / IOE Dig Out2</b>	<b>(Bus IO Out Bit 5 + DO 2 of the first SK xU4-IOE (DigOut 03))</b>		
	<b>[ -07 ] = Bus / 2nd IOE Dig Out1</b>	<b>(Flag1 + DO 1 of the second SK xU4-IOE (DigOut 04))</b>		
	<b>[ -08 ] = Bus / 2nd IOE Dig Out2</b>	<b>(Flag2 + DO 2 of the second SK xU4-IOE (DigOut 05))</b>		
	<b>[ -09 ] = Bit 10 BUS status word</b>			
	<b>[ -10 ] = Bit 13 BUS status word</b>			

**NOTE:** Details for the use of the relevant bus systems can be found in the applicable supplementary bus manual.

### 5.2.6 Additional parameters

Parameter {factory setting}	Setting value / Description / Note		Supervisor	Parameter set
<b>P501</b>	<b>[ -01 ] Inverter name</b> ... <b>[ -20 ]</b> ( <i>Inverter name</i> )			
A...Z <small>(char)</small> { 0 }	Free input of a designation (name) for the device (max. 20 characters). With this, the frequency inverter can be uniquely identified for setting with NORD CON software or within a network.			
<b>P502</b>	<b>[ -01 ] Value master function</b> ... <b>[ -03 ]</b> ( <i>Master function value</i> )		<b>S</b>	<b>P</b>
0 ... 57 { all 0 }	Selection of master values of a Master for output to a bus system (see P503). These master values are assigned at the slave via (P546):			
	<b>[ -01 ] = Master value 1</b>	<b>[ -02 ] = Master value 2</b>	<b>[ -03 ] = Master value 3</b>	
	Selection of possible setting values for master values:			
	<b>00</b> = Off	<b>09</b> = Error number	<b>19</b> = Setpoint frequency Master value	
	<b>01</b> = Actual frequency	<b>10</b> = reserved	<b>20</b> = Setpoint frequency after master value ramp	
	<b>02</b> = Actual speed	<b>11</b> = reserved	<b>21</b> = Actual frequency without master value slip	
	<b>03</b> = Current	<b>12</b> = BusIO Out Bits0-7	<b>22</b> = Speed encoder	
	<b>04</b> = Torque current	<b>13</b> = reserved	<b>23</b> = Actual frequency with slip	
	<b>05</b> = Digital IO status	<b>14</b> = reserved	<b>24</b> = Master value, actual frequency with slip	
	<b>06</b> = reserved	<b>15</b> = reserved	<b>53</b> = Actual value 1 PLC	
	<b>07</b> = reserved	<b>16</b> = reserved	<b>54</b> = Actual value 2 PLC	
	<b>08</b> = Setpoint frequency	<b>17</b> = Value analogue input 1	<b>55</b> = Actual value 3 PLC	
		<b>18</b> = Value analogue input 2		



**NOTE:** For details regarding the processing of setpoints and actual values, please refer to  Section 8.9 "Standardisation of setpoint / target values".

<b>P503</b>	<b>Master function output</b> <i>(Master function output)</i>		<b>S</b>			
0 ... 3 { 0 }	<p>For master-slave applications this parameter specifies on which bus system the master transmits the control word and the master values (P502) for the slave. On the slave, parameters (P509), (P510), (P546 ) define the source from which the slave obtains the control word and the master values from the master and how these are to be processed by the slave.</p> <p>Specification of communication mode on the system bus for ParameterBox and NORDCON.</p> <table style="width: 100%; border: none;"> <tr> <td style="width: 50%; vertical-align: top;"> <p><b>0 = Off</b> <b>No</b> control word and master value output, <i>If no individual BUS option</i> (e.g. SK xU4-IOE) is connected to the system bus, only the device directly connected to the ParameterBox or NORDCON is visible.</p> <p><b>1 = CANopen (system bus)</b> <b>Control word</b> and master values are transferred to the system bus. <i>If no individual bus option</i> (e.g. SK xU4-IOE) is connected to the system bus, only the device directly connected to the ParameterBox or NORDCON is visible.</p> </td> <td style="width: 50%; vertical-align: top;"> <p><b>2 = System bus active</b> <b>No</b> control word and master value output, <b>All</b> FIs connected to the system bus are visible in the ParameterBox or NORDCON, even if no bus option is connected. Prerequisite: all FIs must be set to this mode.</p> <p><b>3 = CANopen + system bus active</b> <b>Control word</b> and master values are transferred to the system bus <b>All</b> FIs connected to the system bus are visible in the ParameterBox or NORDCON, even if no bus option is connected. Prerequisite: all other FIs must be set to mode { 2 } "System bus active"</p> </td> </tr> </table>				<p><b>0 = Off</b> <b>No</b> control word and master value output, <i>If no individual BUS option</i> (e.g. SK xU4-IOE) is connected to the system bus, only the device directly connected to the ParameterBox or NORDCON is visible.</p> <p><b>1 = CANopen (system bus)</b> <b>Control word</b> and master values are transferred to the system bus. <i>If no individual bus option</i> (e.g. SK xU4-IOE) is connected to the system bus, only the device directly connected to the ParameterBox or NORDCON is visible.</p>	<p><b>2 = System bus active</b> <b>No</b> control word and master value output, <b>All</b> FIs connected to the system bus are visible in the ParameterBox or NORDCON, even if no bus option is connected. Prerequisite: all FIs must be set to this mode.</p> <p><b>3 = CANopen + system bus active</b> <b>Control word</b> and master values are transferred to the system bus <b>All</b> FIs connected to the system bus are visible in the ParameterBox or NORDCON, even if no bus option is connected. Prerequisite: all other FIs must be set to mode { 2 } "System bus active"</p>
<p><b>0 = Off</b> <b>No</b> control word and master value output, <i>If no individual BUS option</i> (e.g. SK xU4-IOE) is connected to the system bus, only the device directly connected to the ParameterBox or NORDCON is visible.</p> <p><b>1 = CANopen (system bus)</b> <b>Control word</b> and master values are transferred to the system bus. <i>If no individual bus option</i> (e.g. SK xU4-IOE) is connected to the system bus, only the device directly connected to the ParameterBox or NORDCON is visible.</p>	<p><b>2 = System bus active</b> <b>No</b> control word and master value output, <b>All</b> FIs connected to the system bus are visible in the ParameterBox or NORDCON, even if no bus option is connected. Prerequisite: all FIs must be set to this mode.</p> <p><b>3 = CANopen + system bus active</b> <b>Control word</b> and master values are transferred to the system bus <b>All</b> FIs connected to the system bus are visible in the ParameterBox or NORDCON, even if no bus option is connected. Prerequisite: all other FIs must be set to mode { 2 } "System bus active"</p>					
<b>P504</b>	<b>Pulse frequency</b> <i>(Pulse frequency)</i>		<b>S</b>			
3.0 ... 16.0 kHz { 6.0 }	<p>The internal pulse frequency for controlling the power unit can be changed with this parameter. A higher setting reduces motor noise, but leads to increased EMC emissions and reduction of the possible motor nominal torque.</p> <p><b>NOTE:</b> The best possible degree of interference suppression for the device is adhered to by using the default value and taking the wiring directives into consideration.</p> <p><b>NOTE:</b> Raising the pulse frequency leads to a reduction of the possible output current, depending on the time (<math>I^2t</math> curve). When the temperature warning limit (C001) is reached, the pulse frequency is gradually lowered to the default value. If the inverter temperature drops by a sufficient amount, the pulse frequency is increased to the original value.</p>					
<b>P505</b>	<b>Abs. minimum frequency</b> <i>(Absolute minimum frequency)</i>		<b>S</b>	<b>P</b>		
0.0 ... 10.0 Hz { 2.0 }	<p>Specifies the frequency value that cannot be undershot by the FI. If the setpoint is less than the abs. minimum frequency, the FI switches off or switches to 0.0Hz.</p> <p>At the absolute minimum frequency, braking control (P434) and the setpoint delay (P107) are actuated. If a setting value of "Zero" is selected, the brake relay does not switch during reversing.</p> <p>When controlling lift equipment without speed feedback, this value should be set to a minimum of 2Hz. From 2Hz, the current control of the FI operates and a connected motor can supply sufficient torque.</p> <p><b>NOTE:</b> Output frequencies of &lt; 4.5 Hz lead to current limitation (please see chapter 8.4.3 "Reduced overcurrent due to output frequency").</p>					





{ all 32<sub>dec</sub> }  
 or { all 20<sub>hex</sub> }

**[-01] = Slave address**, Receive address for system bus  
**[-02] = Broadcast slave address**, system bus reception address (slave)  
**[-03] = Master address**, "Broadcast master address", transmission address for system bus (master)

**NOTE:** If up to four FI are to be linked via the system bus, the addresses must be set as follows → FI 1 = 32, FI 2 = 34, FI 3 = 36, FI 4 = 38.

The system bus addresses should be set via DIP switches (chapter 4.3.2.2).

<b>P516</b>	<b>Skip frequency 1</b> (Skip frequency 1)		<b>S</b>	<b>P</b>
0.0 ... 400.0 Hz { 0.0 }	<p>The output frequency around the frequency value (P517) set here is not shown.            This range is transmitted with the set brake and acceleration ramp; it cannot be continuously supplied to the output. Frequencies below the absolute minimum frequency should not be set.  <b>0</b> = Skip frequency inactive</p>			
<b>P517</b>	<b>Skip freq. area 1</b> (Skip frequency area 1)		<b>S</b>	<b>P</b>
0.0 ... 50.0 Hz { 2.0 }	<p>Skip range for the &gt;Skip frequency 1&lt; P516. This frequency value is added and subtracted from the skip frequency.            Skip frequency range 1: P516 - P517 ... P516 + P517</p>			
<b>P518</b>	<b>Skip frequency 2</b> (Skip frequency 2)		<b>S</b>	<b>P</b>
0.0 ... 400.0 Hz { 0.0 }	<p>The output frequency around the set frequency value (P519) is skipped.            This range is transmitted with the set brake and acceleration ramp; it cannot be continuously supplied to the output. Frequencies below the absolute minimum frequency should not be set.  <b>0</b> = Skip frequency inactive</p>			
<b>P519</b>	<b>Skip freq. area 2</b> (Skip frequency area 2)		<b>S</b>	<b>P</b>
0.0 ... 50.0 Hz { 2.0 }	<p>Skip range for the &gt;Skip frequency 2&lt; P518. This frequency value is added and subtracted from the skip frequency.            Skip frequency range 2: P518 - P519 ... P518 + P519</p>			

<b>P520</b>	<b>Flying start</b> (Flying start)		<b>S</b>	<b>P</b>															
0 ... 4 { 0 }	<p>This function is required to connect the FI to already rotating motors, e.g. in fan drives. Motor frequencies &gt;100Hz are only picked up in speed controlled mode (Servo mode P300 = ON).</p> <p><b>0 = Switched off</b>, no flying start.</p> <p><b>1 = Both directions</b>, the FI looks for a speed in both directions.</p> <p><b>2 = Setpoint value direction</b>, searches only in the direction of the setpoint val. which is present.</p> <p><b>3 = Both directions after failure</b>, as for { 1 }, however only after mains failure or fault</p> <p><b>4 = Setpoint direction after fail</b>, as for { 2 }, however only after mains failure or fault</p> <p><b>NOTE:</b> For physical reasons, the flying start circuit only operates above 1/10 of the nominal motor frequency (P201), however, not below <u>10Hz</u>.</p>																		
<table border="1"> <thead> <tr> <th data-bbox="533 613 815 656"></th> <th data-bbox="820 613 1098 656">Example 1</th> <th data-bbox="1102 613 1380 656">Example 2</th> </tr> </thead> <tbody> <tr> <td data-bbox="533 663 815 705"><b>(P201)</b></td> <td data-bbox="820 663 1098 705">50Hz</td> <td data-bbox="1102 663 1380 705">200Hz</td> </tr> <tr> <td data-bbox="533 712 815 754"><b>f=1/10*(P201)</b></td> <td data-bbox="820 712 1098 754">f=5Hz</td> <td data-bbox="1102 712 1380 754">f=20Hz</td> </tr> <tr> <td data-bbox="533 761 815 857">Comparison of f with <math>f_{min}</math> with: <math>f_{min} = 10\text{Hz}</math></td> <td data-bbox="820 761 1098 857">5Hz &lt; 10Hz  The flying start circuit functions above</td> <td data-bbox="1102 761 1380 857">20Hz &lt; 10Hz  The flying start circuit functions above</td> </tr> <tr> <td data-bbox="533 864 815 902"><b>Result <math>f_{Fang}</math>=</b></td> <td data-bbox="820 864 1098 902"><b><u><math>f_{Fang}=10\text{Hz}</math></u></b></td> <td data-bbox="1102 864 1380 902"><b><u><math>f_{Fang}=20\text{Hz}</math></u></b></td> </tr> </tbody> </table>			Example 1	Example 2	<b>(P201)</b>	50Hz	200Hz	<b>f=1/10*(P201)</b>	f=5Hz	f=20Hz	Comparison of f with $f_{min}$ with: $f_{min} = 10\text{Hz}$	5Hz < 10Hz  The flying start circuit functions above	20Hz < 10Hz  The flying start circuit functions above	<b>Result <math>f_{Fang}</math>=</b>	<b><u><math>f_{Fang}=10\text{Hz}</math></u></b>	<b><u><math>f_{Fang}=20\text{Hz}</math></u></b>			
	Example 1	Example 2																	
<b>(P201)</b>	50Hz	200Hz																	
<b>f=1/10*(P201)</b>	f=5Hz	f=20Hz																	
Comparison of f with $f_{min}$ with: $f_{min} = 10\text{Hz}$	5Hz < 10Hz  The flying start circuit functions above	20Hz < 10Hz  The flying start circuit functions above																	
<b>Result <math>f_{Fang}</math>=</b>	<b><u><math>f_{Fang}=10\text{Hz}</math></u></b>	<b><u><math>f_{Fang}=20\text{Hz}</math></u></b>																	
<b>P521</b>	<b>Fly. start resol.</b> (Flying start resolution)		<b>S</b>	<b>P</b>															
0.02... 2.50 Hz { 0.05 }	Using this parameter, the flying start circuit search increment size can be adjusted. Values that are too large affect accuracy and causes the FI to cut out with an overcurrent message. If the values are too small, the search time is greatly extended.																		
<b>P522</b>	<b>Fly. start offset</b> (Flying start offset)		<b>S</b>	<b>P</b>															
-10.0 ... 10.0 Hz { 0.0 }	A frequency value that can be added to the frequency value found, e.g. to remain in the motor range and so avoid the generator range and therefore the chopper range.																		
<b>P523</b>	<b>Factory setting</b> (Factory setting)																		
0 ... 3 { 0 }	<p>With the selection of the relevant value and confirmation via the ENTER key, the selected parameter range is set to factory setting. Once this setting is made, the parameter value automatically changes back to 0.</p> <p><b>0 = No change:</b> Does not change the parameterisation.</p> <p><b>1 = Load factory setting:</b> The complete parameterisation of the FI reverts to the factory setting. All originally parameterised data are lost.</p> <p><b>2 = Factory setting without bus:</b> All parameters of the frequency inverter, with the <u>exception</u> of the bus parameters, are reset to the factory setting.</p> <p><b>3 = Factory setting without motor data:</b> All parameters of the frequency inverter, with the <u>exception</u> of the motor data parameters (P201 ... P209), are reset to the factory setting.</p>																		

<b>P525</b>	[ -01 ] ... [ -03 ]	<b>Load control max</b> (Load monitoring maximum value)		<b>S</b>	<b>P</b>
1 ... 400 % / 401 { all 401 }	Selection of up to 3 auxiliary values: <b>[-01] = Auxiliary value 1      [-02] = Auxiliary value 2      [-03] = Auxiliary value 3</b>				
Maximum load torque value. Setting of the upper limit of load monitoring. Up to 3 values can be specified. Prefixes are not taken into account, only the integer values are processed (motor / generator torque, right/left rotation). The array elements [-01], [-02] and [-03] of parameters (P525) ... (P527), or the entries which are made there always belong together. <b>401 = OFF</b> Means that the function is switched off. No monitoring is performed. This is also the basic setting for the FI.					
<b>P526</b>	[ -01 ] ... [ -03 ]	<b>Load control min</b> (Load monitoring, minimum value)		<b>S</b>	<b>P</b>
0 ... 400 % { all 0 }	Selection of up to 3 auxiliary values: <b>[-01] = Auxiliary value 1      [-02] = Auxiliary value 2      [-03] = Auxiliary value 3</b>				
Minimum load torque. Setting of the lower limit value of load monitoring. Up to 3 values can be specified. Prefixes are not taken into account, only the integer values are processed (motor / generator torque, right/left rotation). The array elements [-01], [-02] and [-03] of parameters (P525) ... (P527), or the entries which are made there always belong together. <b>0 = OFF</b> Means that the function is switched off. No monitoring is performed. This is also the basic setting for the FI.					
<b>P527</b>	[ -01 ] ... [ -03 ]	<b>Load control freq.</b> (Load monitoring frequency)		<b>S</b>	<b>P</b>
0.0 ... 400.0 Hz { all 25.0 }	Selection of up to 3 auxiliary values: <b>[-01] = Auxiliary value 1      [-02] = Auxiliary value 2      [-03] = Auxiliary value 3</b>				
Auxiliary frequency values Definition of up to 3 frequency points, which define the monitoring range for load monitoring. The auxiliary frequency values do not need to be entered in order of size. Prefixes are not taken into account, only the integer values are processed (motor / generator torque, right/left rotation). The array elements [-01], [-02] and [-03] of parameters (P525) ... (P527), or the entries which are made there always belong together.					
<b>P528</b>		<b>Load control delay</b> (Load monitoring delay)		<b>S</b>	<b>P</b>
0.10 ... 320.00 s { 2.00 }	Parameter (P528) defines the delay time for which an error message ("E12.5") is suppressed on infringement of the defined monitoring range ((P525) ... (P527)). A warning ("C12.5") is triggered after half of this time has elapsed. According to the selected monitoring mode (P529) an error message can also be generally suppressed.				

P529	<b>Mode Load control</b> <i>(Load monitoring mode)</i>		S	P
0 ... 3 { 0 }	<p>The reaction of the frequency inverter to an infringement of the defined monitoring range ((P525) ... (P527)) after the elapse of the delay time (P528) is specified by parameter (P529).</p> <p><b>0 = Fault and warning</b>, After the elapse of the time defined in (P528), an infringement of the monitoring range produces a fault ("E12.5"). A warning ("C12.5") is given after the elapse of half of this time.</p> <p><b>1 = Warning</b>, After the elapse of half of the time defined in (P528) and infringement of the monitoring range produces a warning ("C12.5").</p> <p><b>2 = Error and warning, constant travel</b>, "Error and warning during constant travel", as for setting "0" however monitoring is inactive during acceleration phases.</p> <p><b>3 = Warning constant travel</b>, "Only warning during constant travel", as for setting "1", however monitoring is inactive during acceleration phases.</p>			

### P525 ... P529 Load monitoring

With the load monitoring, a range can be specified within which the load torque may change depending on the output frequency. There are three auxiliary values for the maximum permissible torque and three auxiliary values for the minimum permissible torque. A frequency is assigned to each of these auxiliary values. No monitoring is carried out below the first and above the third frequency. In addition, the monitoring can be deactivated for minimum and maximum values. As standard, monitoring is deactivated.

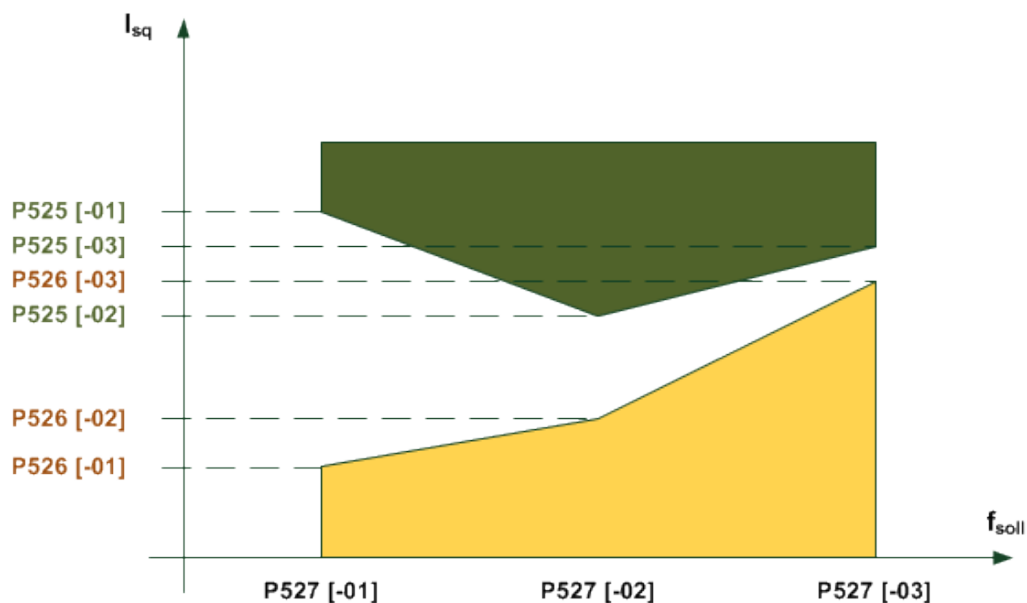

The time after which a fault is triggered can be set with parameter (P528). If the permissible range is exceeded (*Example diagram: Infringement of the area marked in yellow or green*), the error message **E12.5** is generated unless parameter (P529) does not suppress the triggering of an error.

A warning **C12.5** is always given after the elapse of half of the set error triggering time (P528). This also applies if a mode is selected for which no fault message is generated. If only a maximum or minimum value is to be monitored, the other limit must be deactivated or must remain deactivated. The torque current and not the calculated torque is used as the reference value. This has the advantage that monitoring in the "non field weakened range" without servo mode is usually more accurate. Naturally however, it cannot display more than the physical torque in the weakened field range.

All parameters depend on parameter sets. No differentiation is made between motor and generator torque, therefore the value of the torque is considered. As well as this, there is no differentiation between "left" and "right" running. The monitoring is therefore independent of the prefix of the frequency. There are four different load monitoring modes (P529).

The frequencies, and the minimum and maximum values belong together within the various array elements. The frequencies do not need to be sorted according to their magnitude in the elements 0, 1 and 2, as the frequency inverter does this automatically.

<b>P533</b>	<b>Factor I<sup>2</sup>t-Motor</b> (Factor I <sup>2</sup> t-Motor)		<b>S</b>	
50 ... 150 % { 100 }	The motor current for the I <sup>2</sup> t motor monitoring P535 can be weighted with the parameter P533. Larger factors permit larger currents.			
<b>P534</b>	<b>[-01] Torque disconn. limit</b> <b>[-02] (Torque disconnection limit)</b>		<b>S</b>	<b>P</b>
0 ... 400 % / 401 { all 401 }	Via this parameter both the <b>drive</b> [-01] and the <b>generator</b> [-02] switch-off value can be adjusted. If 80% of the set value is reached, a warning status is set. At 100% switch-off is performed with an error message. Error 12.1 is given on exceeding the drive switch-off limit and 12.2 on exceeding the generator switch-off limit.			

**[01]** = drive switch-off limit

**[02]** = generator switch-off limit

**401 = OFF** means that this function has been disabled.



<b>P535</b>	<b>I<sup>2</sup>t motor</b> (I <sup>2</sup> t motor)		
-------------	---	--	--

0 ... 24  
{ 0 }

The motor temperature is calculated depending on the output current, the time and the output frequency (cooling). If the temperature limit value is reached, a switch-off occurs with error message E002 (motor overheating). Possible positive or negative acting ambient conditions cannot be taken into account here.

The I<sup>2</sup>t motor function can be set in a differentiated manner. Eight characteristic curves with three different triggering times (< 5 s, < 10 s and < 20 s) can be set. The triggering times are based on classes 5, 10 and 20 for semiconductor switching devices. The recommended setting for standard applications is P535=5.

All curves run from 0 Hz to half of the nominal frequency (P201). The full nominal current is available from half of the nominal frequency upwards.

With multi-motor operation, the monitoring must be disabled.

**I<sup>2</sup>t- motor off:** Monitoring is inactive

Switch-off class 5, 60 s at (1.5 x I <sub>N</sub> x P533)		Switch-off class 10, 120 s at (1.5 x I <sub>N</sub> x P533)		Switch-off class 20, 240 s at (1.5 x I <sub>N</sub> x P533)	
I <sub>N</sub> at 0 Hz	P535	I <sub>N</sub> at 0 Hz	P535	I <sub>N</sub> at 0 Hz	P535
100%	1	100%	9	100%	17
90%	2	90%	10	90%	18
80%	3	80%	11	80%	19
70%	4	70%	12	70%	20
<b>60%</b>	<b>5</b>	60%	13	60%	21
50%	6	50%	14	50%	22
40%	7	40%	15	40%	23
30%	8	30%	16	30%	24

**NOTE:** Switch-off classes 10 and 20 are provided for applications with heavy starting. When using these switch-off classes, it must be ensured that the FI has a sufficiently high overload capacity.

<b>P536</b>	<b>Current limit</b> (Current limit)		<b>S</b>
-------------	---	--	----------

0.1 ... 2.0 / 2.1  
(x nominal FI current)  
{ 1.5 }

The inverter output current is limited to the set value. If this limit value is reached, the inverter reduces the actual output frequency.

With the analogue input function in P400 = 13/14, this limit value can also be varied and cause an error message (E12.4).

**0.1 ... 2.0 = Multiplier** with the inverter nominal current, gives the limit value.

**2.1 = OFF** means that this limit value is disabled. The FI supplies the maximum possible current.

<b>P537</b>	<b>Pulse disconnection</b> <i>(Pulse disconnection)</i>		<b>S</b>	
10 ... 200 % / 201 { 150 }	<p>This function prevents rapid shutdown of the FI according to the load. With the pulse switch-off enabled, the output current is limited to the set value. This limitation is implemented by brief switching off of individual output stage transistors, the actual output frequency remains unchanged.</p>			
<b>10...200 % =</b>		<b>Limit value in relation to nominal FI current</b>		
<b>201 =</b>		<p><b>The function is so to speak disabled</b>, the FI supplies the maximum possible current. However, at the current limit the pulse switch-off can still be active.</p>		
<p><b>NOTE:</b> The value set here can be undershot by a smaller value in P536.</p>				
<p>With smaller output frequencies (&lt;4.5 Hz) or higher pulse frequencies (&gt;6 kHz or 8 kHz, P504) the pulse switch-off can be undershot by the power reduction (please see chapter 8.4.1 "Increased heat dissipation due to pulse frequency").</p>				
<p><b>NOTE:</b> If the pulse switch-off is disabled (P537=201) and a high pulse frequency is selected in parameter P504, the FI automatically reduces the pulse frequency when the power limit is reached. If the load on the FI is reduced again, the pulse frequency increases back to the original value.</p>				
<b>P539</b>	<b>Output monitoring</b> <i>(Output monitoring)</i>		<b>S</b>	<b>P</b>
0 ... 3 { 0 }	<p>This protective function monitors the output current at the U-V-W terminals and checks for plausibility. In cases of error, the error message E016 is output.</p>			
<p><b>0 = Disabled:</b> Monitoring is not active.</p>				
<p><b>1 = Only motor phases:</b> The output current is measured and checked for symmetry. If an imbalance is present, the FI switches off and outputs the error message E016.</p>				
<p><b>2 = Only magnetisation:</b> At the moment the FI is switched on, the level of the excitation current (field current) is checked. If insufficient excitation current is present, the FI switches off with the error message E016. A motor brake is not released in this phase.</p>				
<p><b>3 = Motor phase + Magnet:</b> Monitoring of the motor phases and magnetisation as in 1 and 2 are combined.</p>				
<p><b>NOTE:</b> This function can be used as an additional protective function for lifting applications, but is not permissible on its own as protection for persons.</p>				

P540	<b>Mode phase sequence</b> <i>(Mode phase sequence)</i>	<b>S</b>	<b>P</b>
0 ... 7 { 0 }	<p>For safety reasons this parameter can be used to prevent a rotation direction reversal and therefore the incorrect rotation direction.</p> <p>This function does not operate with active position control (P600 ≠ 0).</p> <p><b>0 = None, "No restriction of direction of rotation"</b></p> <p><b>1 = Dir key locked</b>, rotation direction change key  of the SimpleBox is locked</p> <p><b>2 = Clockwise only*</b>, only clockwise direction is possible. The selection of the "incorrect" rotation direction leads to the output of the minimum frequency P104 with the field of rotation R.</p> <p><b>3 = Anticlockwise only*</b>, only counter-clockwise direction is possible. The selection of the "incorrect" rotation direction leads to the output of the minimum frequency P104 with the field of rotation L.</p> <p><b>4 = Enable direction only</b>, rotation direction is only possible according to the enable signal, otherwise 0Hz.</p> <p><b>5 = Clockwise only monitored</b>, "<i>Only clockwise monitored</i>", only clockwise rotation is possible. The selection of the "incorrect" rotation direction leads to the FI switching off (control block). If necessary, a sufficiently large setpoint value (<math>&gt;f_{min}</math>) must be observed.</p> <p><b>6 = Only anticlockwise monitored</b>, "<i>Only anticlockwise monitored</i>" *, only anticlockwise rotation is possible. The selection of the "incorrect" rotation direction leads to the FI switching off (control block). If necessary, an adequately large setpoint value (<math>&gt;f_{min}</math>) must be observed.</p> <p><b>7 = Only enable monitored</b>, "<i>Only enabled direction monitored</i>", Rotation direction is only possible according to the enable signal, otherwise the FI is switched off.</p> <p>*) Applies for control via keyboard and control terminals.</p>		

P541	<b>Set relay</b> <i>(set digital output)</i>	<b>S</b>												
0000 ... FFF (hex) { 0000 }	<p>This function provides the opportunity to control the relay and the digital outputs independently of the frequency inverter status. To do this, the relevant output must be set to the function "External control".</p> <p>This function can either be used manually or in combination with a bus control.</p> <table style="width: 100%; border: none;"> <tr> <td style="width: 50%;"><b>Bit 0</b> = Digital output 1</td> <td style="width: 50%;"><b>Bit 6</b> = Digital out 1/1.IOE</td> </tr> <tr> <td><b>Bit 1</b> = Digital output 2</td> <td><b>Bit 7</b> = Digital out 2/1.IOE</td> </tr> <tr> <td><b>Bit 2</b> = Bus/AS-i Out Bit 0</td> <td><b>Bit 8</b> = Digital out 1/2.IOE</td> </tr> <tr> <td><b>Bit 3</b> = Bus/AS-i Out Bit 1</td> <td><b>Bit 9</b> = Digital out 2/2.IOE</td> </tr> <tr> <td><b>Bit 4</b> = Bus/AS-i Out Bit 2</td> <td><b>Bit 10</b> = Bus statusword Bit10</td> </tr> <tr> <td><b>Bit 5</b> = Bus/AS-i Out Bit 3</td> <td><b>Bit 11</b> = Bus statusword Bit13</td> </tr> </table>	<b>Bit 0</b> = Digital output 1	<b>Bit 6</b> = Digital out 1/1.IOE	<b>Bit 1</b> = Digital output 2	<b>Bit 7</b> = Digital out 2/1.IOE	<b>Bit 2</b> = Bus/AS-i Out Bit 0	<b>Bit 8</b> = Digital out 1/2.IOE	<b>Bit 3</b> = Bus/AS-i Out Bit 1	<b>Bit 9</b> = Digital out 2/2.IOE	<b>Bit 4</b> = Bus/AS-i Out Bit 2	<b>Bit 10</b> = Bus statusword Bit10	<b>Bit 5</b> = Bus/AS-i Out Bit 3	<b>Bit 11</b> = Bus statusword Bit13	
<b>Bit 0</b> = Digital output 1	<b>Bit 6</b> = Digital out 1/1.IOE													
<b>Bit 1</b> = Digital output 2	<b>Bit 7</b> = Digital out 2/1.IOE													
<b>Bit 2</b> = Bus/AS-i Out Bit 0	<b>Bit 8</b> = Digital out 1/2.IOE													
<b>Bit 3</b> = Bus/AS-i Out Bit 1	<b>Bit 9</b> = Digital out 2/2.IOE													
<b>Bit 4</b> = Bus/AS-i Out Bit 2	<b>Bit 10</b> = Bus statusword Bit10													
<b>Bit 5</b> = Bus/AS-i Out Bit 3	<b>Bit 11</b> = Bus statusword Bit13													

	Bits 8-11	Bits 7-4	Bits 3-0	
Min. value	0000 <b>0</b>	0000 <b>0</b>	0000 <b>0</b>	Binary <b>hex</b>
Max. value	1111 <b>F</b>	1111 <b>F</b>	1111 <b>F</b>	Binary <b>hex</b>

Changes which are made to the settings are not saved in the EEPROM. After "Power ON" of the frequency inverter, the parameter is therefore in the default setting.

Setting of the value via ...

- BUS:** The corresponding hex value is written into the parameter, thereby setting the relay and digital outputs.
- SimpleBox:** The hexadecimal code is entered directly when the SimpleBox is used.
- ParameterBox:** Each individual output can be separately called up in plain text and activated.

<b>P542</b>	<b>[-01] Set analogue output</b> <b>[-02] (Set analogue output)</b>		<b>S</b>	
0.0 ... 10.0 V { all 0.0 } only with SK CU4-IOE or SK TU4-IOE	<p><b>[-01] =</b> First IOE, AOUT of the <b>first</b> I/O extension (SK xU4IOE)  <b>[-02] =</b> Second IOE, AOUT of the <b>second</b> I/O extension (SK xU4IOE)</p> <p>The analogue output of the FI can be set with this function, independently of the actual operating state. To do this, the relevant analogue output must be set to the function "External control" (P418 = 7).</p> <p>This function can either be used manually or in combination with a bus control. The value set here will, once confirmed, be produced at the analogue output.</p> <p>Changes which are made to the settings are not saved in the EEPROM. After "Power ON" of the frequency inverter, the parameter is therefore in the default setting.</p>			

<b>P543</b>	<b>[-01] Actual bus value 1 ... 3</b> <b>... [-03] (Actual bus value 1 ... 3)</b>		<b>S</b>	<b>P</b>
-------------	--	--	----------	----------

0 ... 55 { [-01] = 1 } { [-02] = 4 } { [-03] = 9 }	<p>The return status value can be selected for bus actuation in this parameter.</p> <p><b>NOTE:</b> For further details, please refer to the relevant bus manual or the description for (P418). (Values from 0% ... 100% correspond to 0000<sub>hex</sub> ... 4000<sub>hex</sub>)  For standardisation of the actual values: (please see chapter 8.9 "Standardisation of setpoint / target values").</p>			
---	--	--	--	--

**[-01] = Actual bus value 1      [-02] = Actual bus value 2      [-03] = Actual bus value 3**

(Definition of frequencies (please see chapter 8.10 "Definition of setpoint and actual value processing (frequencies)"))

- |  |  |
|--|--|
| <b>0 =</b> Off   | <b>18 =</b> Value of analogue input 2,<br>Analogue input 2 (P400[-02]),                                    |
| <b>1 =</b> Actual frequency  | <b>19 =</b> Setpoint frequency master value (P503)   |
| <b>2 =</b> Actual speed  | <b>20 =</b> Target frequency aft. mast. val. ramp,<br>"Setpoint frequency after master value ramp"         |
| <b>3 =</b> Current   | <b>21 =</b> Actual freq. without slip Master value<br>"Actual frequency without master value slip"         |
| <b>4 =</b> Torque current (100% = P112)                              | <b>22 =</b> Reserved   |
| <b>5 =</b> Digital IO* status  | <b>23 =</b> Actual frequency with slip<br>(from software version V1.3)<br>"Actual frequency with slip"     |
| <b>6 =</b> ... 7 Reserved  | <b>24 =</b> Master value Actual freq. w. slip (SW 1.3 and above)<br>"Master value, actual freq. with slip" |
| <b>8 =</b> Setpoint frequency  | <b>53 =</b> Actual value 1 PLC   |
| <b>9 =</b> Error number  | <b>54 =</b> Actual value 2 PLC   |
| <b>10 =</b> ... 11 Reserved  | <b>55 =</b> Actual value 3 PLC   |
| <b>12 =</b> BusIO Out Bits 0-7                                       |  |
| <b>13 =</b> ... 16 Reserved  |  |
| <b>17 =</b> Value analogue input 1,<br>Analogue input 1 (P400[-01]), |  |

\* assignment of the digital inputs for P543 = 5

Bit 0 = DigIn 1 (FI)	Bit 1 = DigIn 2 (FI)	Bit 2 = DigIn 3 (FI)	Bit 3 = DigIn 4 (FI)
Bit 4 = DigIn 5 (FI)	Bit 5 = PTC input [FI]	Bit 6 = reserved	Bit 7 = reserved
Bit 8 = DigIn 6 (DI1, 1. SK...IOE)	Bit 9 = DigIn 7 (DI2, 1. SK...IOE)	Bit 10 = DigIn 8 (DI3, 1. SK...IOE)	Bit 11 = DigIn 9 (DI4, 1. SK...IOE)
Bit 12 = DigOut 1 (FI)	Bit 13 = DigOut 2 (FI)	Bit 14 = reserved	Bit 15 = reserved

<b>P546</b>	<b>[ -01 ] Function Bus setpoint</b> ... <b>[ -03 ]</b> <i>(Function of bus setpoint)</i>		<b>S</b>	<b>P</b>		
0 ... 32 { [-01] = 1 } { [-02] = 0 } { [-03] = 0 }	<p>In this parameter, a function is allocated to the output setpoint during bus actuation.</p> <p><b>NOTE:</b> For further details, please refer to the relevant bus manual or the description for (P400). (Values from 0 % ... 100 % correspond to 0000<sub>hex</sub> ... 4000<sub>hex</sub>.) For standardisation of the setpoint values: (please see chapter 8.9 "Standardisation of setpoint / target values").</p>					
<b>[ -01 ] = Bus setpoint value 1    [ -02 ] = Bus setpoint value 2    [ -03 ] = Bus setpoint value 3</b>						
<b>Possible values which can be set:</b>						
<table style="width: 100%; border: none;"> <tr> <td style="width: 50%; vertical-align: top;"> <b>0 =</b> Off  <b>1 =</b> Setpoint frequency (16 bit)  <b>2 =</b> Frequency addition  <b>3 =</b> Frequency subtraction  <b>4 =</b> Minimum frequency  <b>5 =</b> Maximum frequency  <b>6 =</b> Process controller actual value  <b>7 =</b> Process controller setpoint  <b>8 =</b> Actual frequency PI  <b>9 =</b> Actual freq. PI limited  <b>10 =</b> Actual freq. PI monitored    <b>11 =</b> Torque current limit, "<i>Torque current limited</i>"    <b>12 =</b> Torque current switch-off, "<i>Torque current switch-off limit</i>" </td> <td style="width: 50%; vertical-align: top;"> <b>13 =</b> Current limit, "<i>Current limited</i>"  <b>14 =</b> Current Switch-off "<i>Current switch-off limit</i>"  <b>15 =</b> Ramp time, (P102/103)  <b>16 =</b> Lead torque, ((P214) multiplication)  <b>17 =</b> Multiplication  <b>18 =</b> Curve travel calculator  <b>19 =</b> Servo mode torque  <b>20 =</b> BusIO InBits 0-7  <b>21 =</b> ...25 reserved  <b>31 =</b> Digital output IOE, sets the state of DOUT of the first IOE    <b>32 =</b> Analogue output IOE, sets the value AOUT of the first IOE), condition: P418 = Function "31"            Value must be between 0 and 100 (0<sub>hex</sub> and 64<sub>hex</sub>). Otherwise the minimum value is output at the analogue output. </td> </tr> </table>					<b>0 =</b> Off <b>1 =</b> Setpoint frequency (16 bit) <b>2 =</b> Frequency addition <b>3 =</b> Frequency subtraction <b>4 =</b> Minimum frequency <b>5 =</b> Maximum frequency <b>6 =</b> Process controller actual value <b>7 =</b> Process controller setpoint <b>8 =</b> Actual frequency PI <b>9 =</b> Actual freq. PI limited <b>10 =</b> Actual freq. PI monitored  <b>11 =</b> Torque current limit, " <i>Torque current limited</i> "  <b>12 =</b> Torque current switch-off, " <i>Torque current switch-off limit</i> "	<b>13 =</b> Current limit, " <i>Current limited</i> " <b>14 =</b> Current Switch-off " <i>Current switch-off limit</i> " <b>15 =</b> Ramp time, (P102/103) <b>16 =</b> Lead torque, ((P214) multiplication) <b>17 =</b> Multiplication <b>18 =</b> Curve travel calculator <b>19 =</b> Servo mode torque <b>20 =</b> BusIO InBits 0-7 <b>21 =</b> ...25 reserved <b>31 =</b> Digital output IOE, sets the state of DOUT of the first IOE  <b>32 =</b> Analogue output IOE, sets the value AOUT of the first IOE), condition: P418 = Function "31" Value must be between 0 and 100 (0 <sub>hex</sub> and 64 <sub>hex</sub> ). Otherwise the minimum value is output at the analogue output.
<b>0 =</b> Off <b>1 =</b> Setpoint frequency (16 bit) <b>2 =</b> Frequency addition <b>3 =</b> Frequency subtraction <b>4 =</b> Minimum frequency <b>5 =</b> Maximum frequency <b>6 =</b> Process controller actual value <b>7 =</b> Process controller setpoint <b>8 =</b> Actual frequency PI <b>9 =</b> Actual freq. PI limited <b>10 =</b> Actual freq. PI monitored  <b>11 =</b> Torque current limit, " <i>Torque current limited</i> "  <b>12 =</b> Torque current switch-off, " <i>Torque current switch-off limit</i> "	<b>13 =</b> Current limit, " <i>Current limited</i> " <b>14 =</b> Current Switch-off " <i>Current switch-off limit</i> " <b>15 =</b> Ramp time, (P102/103) <b>16 =</b> Lead torque, ((P214) multiplication) <b>17 =</b> Multiplication <b>18 =</b> Curve travel calculator <b>19 =</b> Servo mode torque <b>20 =</b> BusIO InBits 0-7 <b>21 =</b> ...25 reserved <b>31 =</b> Digital output IOE, sets the state of DOUT of the first IOE  <b>32 =</b> Analogue output IOE, sets the value AOUT of the first IOE), condition: P418 = Function "31" Value must be between 0 and 100 (0 <sub>hex</sub> and 64 <sub>hex</sub> ). Otherwise the minimum value is output at the analogue output.					
<b>P549</b>	<b>PotentiometerBox function</b> <i>(PotentiometerBox function)</i>		<b>S</b>			

0 ... 16  
{ 0 }

This parameter provides the possibility of adding a correction value (fixed frequency, analogue, bus) to the current setpoint value by means of the SimpleBox/ParameterBox keyboard. The adjustment range is determined by the auxiliary setpoint value P410/411.

<b>0 = Off</b> <b>1 = Setpoint frequency</b> , with(P509)≠ 1 control via USS is possible	<b>2 = Frequency addition</b> <b>3 = Frequency subtraction</b>
---	---

<b>P552</b>	<b>[-01] CAN Master cycle</b> <b>[-02] (CAN Master cycle time)</b>		<b>S</b>	
-------------	---	--	----------	--

0.0 / 0.1 ... 100.0 ms  
{ all 0.0 }

In this parameter, the cycle time for the system bus master mode and the CAN open encoder is set (see P503/514/515):

**[01] = CAN Master function**, Cycle time for system bus master functions

**[02] = CANopen Abs. encoder**, "CANopen absolute encoder", system bus cycle time of absolute encoder

With the setting **0 = "Auto"** the default value (see table) is used.

According to the Baud rate set, there are different minimum values for the actual cycle time:

Baud rate	Minimum value t <sub>z</sub>	Default CAN Master	Default CANopen Abs.
10kBaud	10ms	50ms	20ms
20kBaud	10ms	25ms	20ms
50kBaud	5ms	10ms	10ms
100kBaud	2ms	5ms	5ms
125kBaud	2ms	5ms	5ms
250kBaud	1ms	5ms	2ms
500kBaud	1ms	5ms	2ms
1000kBaud:	1ms	5ms	2ms

<b>P553</b>	<b>[-01] PLC setpoints</b> ... <b>[-03] (PLC setpoints)</b>		<b>S</b>	<b>P</b>
-------------	---	--	----------	----------

0 ... 36  
all = { 0 }

The PLC setpoints are assigned with a function in this parameter. The settings only apply for main setpoints and with active PLC actuation ((P350) = "On") and ((P351) = "0" or "1").

**[-01] = Bus setpoint value 1** ... **[-03] = Bus setpoint 3**

**Possible values which can be set:**

- |   |  |
|---|--|
| <b>0</b> = Off                              | <b>17</b> = Multiplication                     |
| <b>1</b> = Setpoint frequency               | <b>18</b> = Curve travel calculator            |
| <b>2</b> = Frequency addition               | <b>19</b> = Servo mode torque                  |
| <b>3</b> = Frequency subtraction            | <b>20</b> = BusIO In Bits 0-7                  |
| <b>4</b> = Minimum frequency                | <b>21</b> = Setpoint position Low word         |
| <b>5</b> = Maximum frequency                | <b>22</b> = Setpoint pos. HighWord             |
| <b>6</b> = Process controller actual value  | <b>23</b> = Setpoint pos. Inc.LowWord          |
| <b>7</b> = Process controller setpoint      | <b>24</b> = Target pos.Inc.HighWord            |
| <b>8</b> = Actual frequency PI              | <b>25</b> = Gear ratio factor                  |
| <b>9</b> = Actual PI freq. limited          | <b>26</b> = ... 30: Reserved                   |
| <b>10</b> = Actual PI freq. monitored       | <b>31</b> = Digital output IOE                 |
| <b>11</b> = Torque current limit (limiting) | <b>32</b> = Analog output IOE                  |
| <b>12</b> = Torque current switch-off limit | <b>33</b> = Torque process controller setpoint |
| <b>13</b> = Current limit (limiting)        | <b>34</b> = d-correction F process             |
| <b>14</b> = Current switch-off limit        | <b>35</b> = d-correction Torque                |
| <b>15</b> = Ramp time                       | <b>36</b> = d-correction F+Torque              |
| <b>16</b> = Torque precontrol               |  |

<b>P555</b>	<b>Chopper P limitation</b> (Chopper power limitation)		<b>S</b>	
5 ... 100 % { 100 }	<p>With this parameter it is possible to program a manual (peak) power limit for the brake resistor. The switch-on delay (modulation level) for the chopper can only rise to a certain maximum specified limit. Once this value has been reached, irrespective of the level of the link voltage, the inverter switches off the current to the resistor.</p> <p>The result would be an overvoltage switch-off of the FI.</p> <p>The correct percentage value is calculated as follows: <math>k[\%] = \frac{R * P_{\max BW}}{U_{\max}^2} * 100\%</math></p> <p>R = Resistance of the brake resistor  P<sub>maxBW</sub> = Momentary peak power of the brake resistor  U<sub>max</sub> = FI chopper switching threshold</p> <p>1~ 115/230 V ⇒ 440 V=  3~ 230 V ⇒ 440 V=  3~ 400 V ⇒ 840 V=</p> <p><b>NOTE:</b> This parameter is <b>only</b> relevant for <b>size 2</b>.</p>			
<b>P556</b>	<b>Braking resistor</b> (Brake resistor)		<b>S</b>	
20 ... 400 Ω { 120 }	<p>Value of the brake resistance for the calculation of the maximum brake power to protect the resistor.</p> <p>Once the maximum continuous output (<b>P557</b>) including overload (200 % for 60 s) is reached, an I<sup>2</sup>t limit error (<b>E003.1</b>) is triggered. Further details in (<b>P737</b>).</p> <p><b>NOTE:</b> This parameter is <b>only</b> relevant for <b>size 2</b>.</p>			
<b>P557</b>	<b>Brake resistor type</b> (Brake resistor power)		<b>S</b>	
0.00 ... 20.00 kW { 0.00 }	<p>Continuous power (nominal power) of the resistor, to display the actual utilisation in (<b>P737</b>). For a correctly calculated value, the correct value must be entered into (<b>P556</b>) and (<b>P557</b>).</p> <p><b>0.00</b> = Monitoring disabled</p> <p><b>NOTE:</b> This parameter is <b>only</b> relevant for <b>size 2</b>.</p>			
<b>P558</b>	<b>Flux delay</b> (Flux delay)		<b>S</b>	<b>P</b>
0 / 1 / 2 ... 5000 ms { 1 }	<p>The ISD control can only function correctly if there is a magnetic field in the motor. For this reason, a DC current is applied before starting the motor to provide the excitation of the stator winding. The duration depends on the size of the motor and is automatically set in the factory setting of the FI.</p> <p>For time-critical applications, the magnetizing time can be set or deactivated.</p> <p><b>0</b> = Disabled  <b>1</b> = Automatic calculation  <b>2 ... 5000</b> = Time set in [ms]</p> <p><b>NOTE:</b> Setting values that are too low can reduce the dynamics and starting torque.</p>			

<b>P559</b>	<b>DC Run-on time</b> (DC Run-on time)		<b>S</b>	<b>P</b>
0.00 ... 30.00 s { 0.50 }	<p>Following a stop signal and the braking ramp, a direct current is briefly applied to the motor to fully bring the drive to a stop. Depending on the inertia, the time for which the current is applied can be set in this parameter.</p> <p>The current level depends on the previous braking procedure (current vector control) or the static boost (linear characteristic).</p>			
<b>P560</b>	<b>Parameter, Saving mode</b> (Saving mode parameter)		<b>S</b>	
0 ... 2 { 1 }	<p><b>0 = Only in RAM</b>, changes to the parameter settings are no longer saved on the EEPROM. All previously saved settings are retained, even if the FI is disconnected from the mains.</p> <p><b>1 = RAM and EEPROM</b>, all parameter changes are automatically written to the EEPROM and remain stored there even if the FI is disconnected from the mains supply.</p> <p><b>2 = OFF</b>, no saving in RAM <u>and</u> EEPROM possible (<u>no</u> parameter changes are accepted)</p> <p><b>NOTE:</b> If BUS communication is used to implement parameter changes, it must be ensured that the maximum number of write cycles (100,000 x) in the EEPROM is not exceeded.</p>			

### 5.2.7 Information

Parameter	Setting value / Description / Note		Supervisor	Parameter set
<b>P700</b>	<b>Actual operating status</b> (Actual operating status)			
0.0 ... 25.4	<p>Display of current messages for the present operating status of the frequency inverter such as faults, warnings or the reason why switch-on is disabled (please see chapter 6 "Operating status messages").</p> <p><b>[-01] = Present fault</b>, shows the currently active (unacknowledged) fault (please see section "Error messages").</p> <p><b>[-02] = Present warning</b>, indicates a current warning message (please see section "Warning messages").</p> <p><b>[-03] = Reason for disabled starting</b>, indicates the reason for an active start disable (please see section "Switch-on block messages").</p> <p><b>NOTE</b></p> <p><i>SimpleBox / ControlBox:</i> the error numbers of the warning messages and faults can be displayed using SimpleBox and ControlBox.</p> <p><i>ParameterBox:</i> with the ParameterBox the messages are displayed in plain text.. In addition, the reason for a possible disabling of starting can also be displayed.</p> <p><i>Bus:</i> The display of bus-level error messages is displayed in decimal integer format. The displayed value must be divided by 10 in order to correspond with the correct format.</p> <p>Example: Display: 20 → Error number: 2.0</p>			



<b>P701</b>	[-01] ... [-05]	<b>Last fault 1 ... 5</b> <i>(Last fault 1...5)</i>			
0.0 ... 25.4      This parameter stores the last 5 faults (please see section "Error messages"). The SimpleBox / ControlBox must be used to select the corresponding memory location 1...5- (Array parameter), and confirmed using the OK / ENTER key to read the stored error code.					
<b>P702</b>	[-01] ... [-05]	<b>Last frequency error</b> <i>(Last frequency error 1...5)</i>		<b>S</b>	
-400.0 ... 400.0 Hz      This parameter stores the output frequency that was being delivered at the time the fault occurred. The values of the last 5 errors are stored. The SimpleBox / ControlBox must be used to select the corresponding memory location 1...5- (Array parameter), and confirmed using the OK- / ENTER key to read the stored error code.					
<b>P703</b>	[-01] ... [-05]	<b>Current last error</b> <i>(Last current error 1...5)</i>		<b>S</b>	
0.0 ... 999.9 A      This parameter stores the output current that was being delivered at the time the fault occurred. The values of the last 5 errors are stored. The SimpleBox / ControlBox must be used to select the corresponding memory location 1...5- (Array parameter), and confirmed using the OK / ENTER key to read the stored error code.					
<b>P704</b>	[-01] ... [-05]	<b>Volt. last error</b> <i>(Last voltage error 1...5)</i>		<b>S</b>	
0 ... 600 V AC      This parameter stores the output voltage that was being delivered at the time the fault occurred. The values of the last 5 errors are stored. The SimpleBox / ControlBox must be used to select the corresponding memory location 1...5- (Array parameter), and confirmed using the OK / ENTER key to read the stored error code.					
<b>P705</b>	[-01] ... [-05]	<b>Last link circuit error</b> <i>(Last link circuit error 1...5)</i>		<b>S</b>	
0 ... 1000 V DC      This parameter stores the link voltage that was being delivered at the time the error occurred. The values of the last 5 errors are stored. The SimpleBox / ControlBox must be used to select the corresponding memory location 1...5- (Array parameter), and confirmed using the OK / ENTER key to read the stored error code.					

<b>P706</b>	[ -01] ... [ -05]	<b>P set last error</b> (Parameter set, last error 1... 5)		<b>S</b>	
0 ... 3	<p>This parameter stores the parameter set code that was active when the error occurred. Data for the previous 5 faults are stored.</p> <p>The SimpleBox / ControlBox must be used to select the corresponding memory location 1...5- (Array parameter), and confirmed using the OK / ENTER key to read the stored error code.</p>				

<b>P707</b>	[ -01] ... [ -03]	<b>Software-Version</b> (Software version/ revision)			
0.0 ... 9999.9	<p>This parameter shows the software and revision numbers in the FI. This can be significant when different FIs are assigned the same settings.</p> <p>Array 03 provides information about any special versions of the hardware or software A zero stands for the standard version.</p> <p>... [-01] = Version number (Vx.x)          ... [-02] = Revision number (Rx)          ... [-03] = Special version of hardware/software (0.0)</p>				

<b>P708</b>	<b>Status of digital input</b> (Status of digital input)				
00000 ... 11111 (bin) or 0000 ... FFFF (hex)	<p>Displays the status of the digital inputs in binary/hexadecimal code. This display can be used to check the input signals.</p> <p><b>Bit 0</b> = Digital input 1  <b>Bit 1</b> = Digital input 2  <b>Bit 2</b> = Digital input 3  <b>Bit 3</b> = Digital input 4  <b>Bit 4</b> = Digital input 5  <b>Bit 5</b> = Thermistor input  <b>Bits 6 - 7</b> reserved</p>				

<p><u>First SK xU4-IOE (optional)</u></p> <p><b>Bit 8</b> = 1: IO extension: Digital input 1  <b>Bit 9</b> = 1: IO extension: Digital input 2  <b>Bit 10</b> = 1: IO extension: Digital input 3  <b>Bit 11</b> = 1: IO extension: Digital input 4</p>	<p><u>Second SK xU4-IOE (optional)</u></p> <p><b>Bit 12</b> = 2: IO extension: Digital input 1  <b>Bit 13</b> = 2: IO extension: Digital input 2  <b>Bit 14</b> = 2: IO extension: Digital input 3  <b>Bit 15</b> = 2: IO extension: Digital input 4</p>
---	--

	Bits 15-12	Bits 11-8	Bits 7-4	Bits 3-0	
<b>Minimum value</b>	0000 0	0000 0	0000 0	0000 0	Binary <b>hex</b>
<b>Maximum value</b>	1111 F	1111 F	1111 F	1111 F	Binary <b>hex</b>

**SimpleBox:** The binary bits are converted to a hexadecimal value and displayed.  
**ParameterBox:** The Bits are displayed increasing from right to left (binary).

<b>P709</b>	[-01] ... [-07]	<b>Analog input voltage</b> (Voltage analogue input)					
-100 ... 100 %	Displays the measured analogue input value.  [-01] = <b>Analogue input 1</b> , function of analogue input 1 integrated into the FI [-02] = <b>Analogue input 2</b> , function of analogue input 2 integrated into the FI [-03] = <b>Ext. analogue input 1</b> , AIN 1 of the <u>first</u> I/O extension SK xU4-IOE [-04] = <b>Ext. analogue input 2</b> , AIN2 of the <u>first</u> I/O extension SK xU4-IOE [-05] = <b>Ext. A.in. 1 2nd IOE</b> , "External analogue input 1 2nd IOE", AIN1 of the <u>second</u> I/O extension (SK xU4-IOE) (= Analogue input 3) [-06] = <b>Ext. A.in. 2 2nd IOE</b> , "External analogue input 2 2nd IOE", AIN2 of the <u>second</u> I/O extension (SK xU4-IOE) (= Analogue input 4) [-07] = <b>Setpoint module</b> , SK SSX-3A, see <a href="#">BU0040</a>						
<b>P710</b>	[-01] [-02]	<b>Analogue output volt.</b> (Analogue output voltage)					
0.0 ... 10.0 V	Displays the delivered value of analogue output. [-01] = <b>First IOE</b> , AOUT of the <u>first</u> I/O extension (SK xU4-IOE) [-02] = <b>Second IOE</b> , AOUT of the <u>second</u> I/O extension (SK xU4-IOE)						
<b>P711</b>		<b>State of relays</b> (state of digital outputs)					
00000 ... 11111 (bin) or 00 ... FF (hex)	Indicates the actual status of the digital outputs of the frequency inverter.  <table border="0" style="width: 100%;"> <tr> <td style="width: 50%; vertical-align: top;"> <b>Bit 0</b> = Digital output 1  <b>Bit 1</b> = Digital output 2  <b>Bit 2</b> = reserved  <b>Bit 3</b> = reserved                 </td> <td style="width: 50%; vertical-align: top;"> <b>Bit 4</b> = Digital output 1, IO extension 1  <b>Bit 5</b> = Digital output 2, IO extension 1  <b>Bit 6</b> = Digital output 1, IO extension 2  <b>Bit 7</b> = Digital output 2, IO extension 2                 </td> </tr> </table>					<b>Bit 0</b> = Digital output 1 <b>Bit 1</b> = Digital output 2 <b>Bit 2</b> = reserved <b>Bit 3</b> = reserved	<b>Bit 4</b> = Digital output 1, IO extension 1 <b>Bit 5</b> = Digital output 2, IO extension 1 <b>Bit 6</b> = Digital output 1, IO extension 2 <b>Bit 7</b> = Digital output 2, IO extension 2
<b>Bit 0</b> = Digital output 1 <b>Bit 1</b> = Digital output 2 <b>Bit 2</b> = reserved <b>Bit 3</b> = reserved	<b>Bit 4</b> = Digital output 1, IO extension 1 <b>Bit 5</b> = Digital output 2, IO extension 1 <b>Bit 6</b> = Digital output 1, IO extension 2 <b>Bit 7</b> = Digital output 2, IO extension 2						
			Bits 7-4	Bits 3-0			
Minimum value			0000	0000	Binary		
			0	0	hex		
Maximum value			1111	1111	Binary		
			F	F	hex		
<b>SimpleBox:</b> The binary bits are converted to a hexadecimal value and displayed. <b>ParameterBox:</b> The bits are displayed increasing from right to left (binary).							
<b>P714</b>		<b>Operating time</b> (Operating time)					
0.10 ... ___ h	This parameter shows the time for which the FI was connected to the mains and was ready for operation.						
<b>P715</b>		<b>Running time</b> (Enablement time)					
0.00 ... ___ h	This parameter shows the time for which the FI was enabled and supplied current to the output.						

<b>P716</b>	<b>Current frequency</b> (Actual frequency)			
-400.0 ... 400.0 Hz	Displays the actual output frequency.			
<b>P717</b>	<b>Current speed</b> (Actual rotation speed)			
-9999 ... 9999 rpm	Displays the actual motor speed calculated by the FI.			
<b>P718</b>	<b>Present Actual setpoint frequency</b> (Actual setpoint frequency)			
-400.0 ... 400.0 Hz	Displays the frequency specified by the setpoint (please see chapter 8.1 "Setpoint processing"). [-01] = Actual setpoint frequency from the setpoint source [-02] = Actual setpoint frequency after processing in the FI status machine [-03] = Actual setpoint frequency after frequency ramp			
<b>P719</b>	<b>Actual current</b> (Actual current)			
0.0 ... 999.9 A	Displays the actual output current.			
<b>P720</b>	<b>Act. torque current</b> (Actual torque current)			
-999.9 ... 999.9 A	Displays the actual calculated torque-developing output current (active current). Basis for calculation are the motor data P201...P209. → negative values = generator, → positive values = drive			
<b>P721</b>	<b>Actual field current</b> (Actual field current)			
-999.9 ... 999.9 A	Displays the actual calculated field current (reactive current). Basis for calculation are the motor data P201...P209.			
<b>P722</b>	<b>Current voltage</b> (Actual voltage)			
0 ... 500 V	Displays the actual AC voltage supplied by the FI output.			
<b>P723</b>	<b>Voltage -d</b> (Actual voltage component $U_d$ )		<b>S</b>	
-500 ... 500 V	Displays the actual field voltage component.			
<b>P724</b>	<b>Voltage -q</b> (Actual voltage component $U_q$ )		<b>S</b>	
-500 ... 500 V	Displays the actual torque voltage component.			

<b>P725</b>	<b>Current Cos phi</b> (Actual cos $\phi$ )			
0.00 ... 1.00	Displays the actual calculated cos $\phi$ of the drive.			
<b>P726</b>	<b>Apparent power</b> (Apparent power)			
0.00 ... 300.00 kVA	Displays the actual calculated apparent power. The basis for calculation are the motor data P201...P209.			
<b>P727</b>	<b>Mechanical power</b> (Mechanical power)			
-99.99 ... 99.99 kW	Displays the actual calculated effective power of the motor. Basis for calculation are the motor data P201...P209.			
<b>P728</b>	<b>Input voltage</b> (mains voltage)			
0 ... 1000 V	Displays the actual mains voltage at the FI input. This is directly determined from the amount of the intermediate circuit voltage			
<b>P729</b>	<b>Torque</b> (Torque)			
-400 ... 400 %	Displays the actual calculated torque. Basis for calculation are the motor data P201...P209.			
<b>P730</b>	<b>Field</b> (Field)			
0 ... 100 %	Displays the actual field in the motor calculated by the FI. The basis for calculation are the motor data P201...P209.			
<b>P731</b>	<b>Parameter set</b> (Actual parameter set)			
0 ... 3	Shows the actual operating parameter set.			
	0 = Parameter set 1	2 = Parameter set 3		
	1 = Parameter set 2	3 = Parameter set 4		
<b>P732</b>	<b>Phase U current</b> (U phase current)		<b>S</b>	
0.0 ... 999.9 A	Displays the actual U phase current.			
	<b>NOTE:</b> This value can deviate somewhat from the value in P719, due to the measurement procedure used, even with symmetrical output currents.			

<b>P733</b>	<b>Phase V current</b> (V phase current)		<b>S</b>	
0.0 ... 999.9 A	Displays the actual V phase current. <b>NOTE:</b> This value can deviate somewhat from the value in P719, due to the measurement procedure used, even with symmetrical output currents.			
<b>P734</b>	<b>Phase W current</b> (W phase current)		<b>S</b>	
0.0 ... 999.9 A	Displays the actual W phase current. <b>NOTE:</b> This value can deviate somewhat from the value in P719, due to the measurement procedure used, even with symmetrical output currents.			
<b>P735</b>	<b>reserved</b>		<b>S</b>	
<b>P736</b>	<b>D.c. link voltage</b> (DC link voltage)			
0 ... 1000 V DC	Displays the actual link voltage.			
<b>P737</b>	<b>Usage rate brakeres.</b> (Actual brake resistor usage rate)			
0 ... 1000 %	This parameter provides information about the actual degree of modulation of the brake chopper or the current utilisation of the braking resistor in generator mode. If parameters P556 and P557 are correctly set, the utilisation related to P557, the resistor power, is displayed. If only P556 is correctly set (P557=0), the degree of modulation of the brake chopper is displayed. Here, 100 means that the brake resistor is fully switched. On the other hand, 0 means that the brake chopper is not active at present. If P556 = 0 and P557 = 0, this parameter also provides information about the degree of modulation of the brake chopper in the FI.  <b>NOTE:</b> This parameter is <b>only</b> relevant for <b>size 2</b> .			
<b>P738</b>	[ -01 ] <b>Motor usage rate</b> [ -02 ] (current motor usage rate)			
0 ... 1000 %	Shows the actual motor load. Basis for calculation is the motor data P203. The actually recorded current is related to the nominal motor current.  [ -01 ] = in relation to $I_N$ (P203) of the motor [ -02 ] = in relation to $I^2t$ monitoring, "in relation to $I^2t$ monitoring" (P535)			
<b>P739</b>	[ -01 ] <b>Heatsink temperature</b> ... [ -03 ] (Present heat sink temperature)			
-40 ... 150 °C	[ -01 ] = Heat sink temperature of FI [ -02 ] = Ambient temperature of FI [ -03 ] = Temp. Motor KTY, motor temperature via KTY			

P740	[-01] ... [-17]	<b>PZD bus In</b> <i>(Process data Bus In)</i>		<b>S</b>	
0000 ... FFFF (hex)		<p>This parameter provides information about the actual control word and the setpoints that are transferred via the bus systems.</p> <p>For display, a BUS system must be selected in P509.</p> <p>Standardisation: (see section (please see chapter 8.9 "Standardisation of setpoint / target values"))</p>	<p><b>[-01]</b> = Control word</p> <p><b>[-02]</b> = Setpoint 1 (P510/1, P546)</p> <p><b>[-03]</b> = Setpoint 2 (P510/1, ...)</p> <p><b>[-04]</b> = Setpoint 3 (P510/1, ...)</p> <p><b>[-05]</b> = res.status InBit P480</p> <p><b>[-06]</b> = Parameter data In 1</p> <p><b>[-07]</b> = Parameter data In 2</p> <p><b>[-08]</b> = Parameter data In 3</p> <p><b>[-09]</b> = Parameter data In 4</p> <p><b>[-10]</b> = Parameter data In 5</p> <p><b>[-11]</b> = Setpoint 1 (P510/2)</p> <p><b>[-12]</b> = Setpoint 2 (P510/2)</p> <p><b>[-13]</b> = Setpoint 3 (P510/2)</p> <p><b>[-14]</b> = Control word PLC</p> <p><b>[-15]</b> = Setpoint 1 PLC</p> <p>...</p> <p><b>[-17]</b> = Setpoint 3 PLC</p>	<p><b>S</b></p>	<p>Control word, source from P509.</p> <p>Setpoint data from main setpoint (P510 [-01]).</p> <p>The displayed value depicts all Bus In Bit sources linked with an "OR".</p> <p>Data during parameter transfer: Order label (AK), Parameter number (PNU), Index (IND), Parameter value (PWE 1/2)</p> <p>Setpoint data from the master function value (Broadcast) - (P502/P503), if P509 = 4</p> <p>Control word + Setpoint data from PLC</p>
<hr/>					
P741	[-01] ... [-17]	<b>PZD bus Out</b> <i>(Process data Bus Out)</i>		<b>S</b>	
0000 ... FFFF (hex)		<p>This parameter provides information about the actual status word and the actual values that are transferred via the bus systems.</p> <p>Standardisation: (see section (please see chapter 8.9 "Standardisation of setpoint / target values"))</p>	<p><b>[-01]</b> = Status word</p> <p><b>[-02]</b> = Actual value 1 (P543)</p> <p><b>[-03]</b> = Actual value 2 (...)</p> <p><b>[-04]</b> = Actual value 3 (...)</p> <p><b>[-05]</b> = res.status OutBit P481</p> <p><b>[-06]</b> = Parameter data Out 1</p> <p><b>[-07]</b> = Parameter data Out 2</p> <p><b>[-08]</b> = Parameter data Out 3</p> <p><b>[-09]</b> = Parameter data Out 4</p> <p><b>[-10]</b> = Parameter data Out 5</p> <p><b>[-11]</b> = Actual value 1 master funct.</p> <p><b>[-12]</b> = Actual value 2 master funct.</p> <p><b>[-13]</b> = Actual value 3 master funct.</p> <p><b>[-14]</b> = Status word PLC</p> <p><b>[-15]</b> = Actual value 1 PLC</p> <p>...</p> <p><b>[-17]</b> = Actual value 3 PLC</p>	<p><b>S</b></p>	<p>Status word, source from P509.</p> <p>Actual values</p> <p>The displayed value depicts all Bus OUT Bit sources linked with an "OR".</p> <p>Data during parameter transfer.</p> <p>Actual value of master function P502 / P503.</p> <p>Status word + Actual values to PLC</p>

<b>P742</b>	<b>Data base version</b> <i>(Database version)</i>		<b>S</b>	
0 ... 9999	Displays the internal database version of the FI.			
<b>P743</b>	<b>Inverter type</b> <i>(Inverter type)</i>			
0.00 ... 250.00	Displays the inverter power in kW, e.g. "1.50" ⇒ FI with 1.5 kW nominal power.			
<b>P744</b>	<b>Configuration level</b> <i>(Configuration level)</i>			
0000 ... FFFF (hex)	This parameter displays the special devices integrated in the FI. Display is in hexadecimal code (SimpleBox, Bus System). The display is in plain text when the ParameterBox is used.			
	<b>High byte:</b>		<b>Low byte:</b>	
	00 <sub>hex</sub> No extension		00 <sub>hex</sub> Standard I/O	(SK 180E)
	01 <sub>hex</sub> reserved		01 <sub>hex</sub> AS-i	(SK 190E)
	02 <sub>hex</sub> reserved		02 <sub>hex</sub> --	
<b>P746</b>	<b>Module status</b> <i>(Operating status of module)</i>	<b>SK 190E</b>		
0000 ... 0111 (bin) or 00 ... 07 (hex)	Displays the current operating status of the AS interface. <b>Bit 0 =</b> AS interface voltage is present <b>Bit 1 =</b> AS interface watchdog set to active by master <b>Bit 2 =</b> AS interface connected			
	<b>SimpleBox:</b> The binary bits are converted to a hexadecimal value and displayed. <b>ParameterBox:</b> The bits are displayed increasing from right to left (binary).			
<b>P747</b>	<b>Inverter Volt. Range</b> <i>(Inverter voltage range)</i>			
0 ... 2	Indicates the mains voltage range for which this device is specified. <b>0 =</b> 100...120V <b>1 =</b> 200...240V <b>2 =</b> 380...480V			



<b>P748</b>	<b>CANopen status</b> (CANopen status (system bus status))			
0000 ... FFFF (hex) or 0 ... 65535 (dec)	Shows the status of the system bus.			
	Bit 0:	24V Bus supply voltage		
	Bit 1:	CANbus in "Bus Warning" status		
	Bit 2:	CANbus in "Bus Off" status		
	Bit 3:	System bus → Bus module online (field bus module, e.g.: SK xU4-PBR)		
	Bit 4:	System bus → Additional module 1 online (I/O - module, e.g.: SK xU4-IOE)		
	Bit 5:	System bus → Additional module 2 online (I/O - module, e.g.: SK xU4-IOE)		
	Bit 6:	The protocol of the CAN module is            0 = CAN / 1 = CANopen		
	Bit 7:	Vacant		
	Bit 8:	"Bootup Message" sent		
	Bit 9:	CANopen NMT State		
	Bit 10:	CANopen NMT State		
		CANopen NMT State	Bit 10	Bit 9
		Stopped	0	0
		Pre- Operational	0	1
		Operational	1	0
<b>P749</b>	<b>Status of DIP switches</b> (Status of DIP switches)			
0000 ... 0007 (hex) or 0 ... 007 (dec)	This parameter shows the actual setting of the FI DIP switch "S2" (See BU0200)(please see chapter 4.3.2.2 "DIP switches (S1, S2)").			
	Bit 0:	DIP switch 1		
	Bit 1:	DIP switch 2		
	Bit 2:	DIP switch 3		
<b>P750</b>	<b>Stat. overcurrent</b> (Overcurrent statistics)		<b>S</b>	
0 ... 9999	Number of overcurrent messages during the operating period P714.			
<b>P751</b>	<b>Stat. Overvoltage</b> (Overvoltage statistics)		<b>S</b>	
0 ... 9999	Number of overvoltage messages during the operating period P714.			
<b>P752</b>	<b>Stat. mains failure</b> (Mains failure statistics)		<b>S</b>	
0 ... 9999	Number of mains faults during the operating period P714.			
<b>P753</b>	<b>Stat. overtemperature</b> (Overheating statistics)		<b>S</b>	
0 ... 9999	Number of overtemperature faults during the operating period P714.			

<b>P754</b>	<b>Stat. parameter lost</b> <i>(Parameter loss statistics)</i>		<b>S</b>	
0 ... 9999	Number of parameters lost during the operating period P714.			
<b>P755</b>	<b>Stat. system error</b> <i>(System fault statistics)</i>		<b>S</b>	
0 ... 9999	Number of system faults during the operating period P714.			
<b>P756</b>	<b>Stat. Timeout</b> <i>(Time out statistics)</i>		<b>S</b>	
0 ... 9999	Number of Time out errors during the operating period P714.			
<b>P757</b>	<b>Stat. Customer error</b> <i>(Customer fault statistics)</i>		<b>S</b>	
0 ... 9999	Number of Customer Watchdog faults during the operating period P714.			
<b>P760</b>	<b>Actual mains current</b> <i>(Actual mains current)</i>		<b>S</b>	
0.0 ... 999.9 A	Displays the actual input current.			
<b>P799</b>	<b>Op.-time last error</b> <i>(Operating time, last fault 1...5)</i>			
0.1 ... ___ h	This parameter shows the operating hours counter status (P714) at the moment of the previous fault. Array 01...05 corresponds to the latest fault 1...5.			

### 6 Operating status messages

The device and technology units generate appropriate messages if they deviate from their normal operating status. There is a differentiation between warning and error messages. If the device is in the status "Start disabled", the reason for this can also be displayed.

The messages generated for the device are displayed in the corresponding array of parameter (**P700**). The display of the messages for technology units is described in the respective additional instructions and data sheets for the modules concerned.

#### Start disabled, "Not Ready" → (P700 [-03])

If the device is in the status "Not Ready" or "Start Disabled", the reason for this is indicated in the third array element of parameter (**P700**).

Display is only possible with the NORD CON software or the ParameterBox.

#### Warning messages → (P700 [-02])

Warning messages are generated as soon as a defined limit is reached. However this does not cause the frequency inverter to switch off. These messages can be displayed via the array-element [-02] in parameter (**P700**) until either the reason for the warning is no longer present or the frequency inverter has gone into a fault state with an error message.

#### Error messages → (P700 [-01])

Errors cause the device to switch off, in order to prevent a device fault.

The following options are available to reset a fault (acknowledge):

- Switching the mains off and on again,
- By an appropriately programmed digital input (**P420**),
- By switching off the "enable" on the device (if no digital input is programmed for acknowledgement),
- By Bus acknowledgement
- By (**P506**), automatic error acknowledgement.

#### 6.1 Display of messages

##### LED displays

The status of the FI is indicated by integrated status LEDs, which are visible from the outside in the state as delivered. According to the type of FI, this is a two-colour LED (DS = DeviceState) or two single-colour LEDs (DS DeviceState and DE = DeviceError).

<b>Meaning:</b>	<p><b>Green</b> indicates readiness and the present of mains voltage. In operation, the level of overload at the FI output is shown with an increasingly rapid flashing code.</p> <p><b>Red</b> Signals the presence of an error by flashing according to the number code of the error. This flashing code (e.g.: E003 = 3x flashing) indicates the error groups.</p>
-----------------	---

### SimpleBox Display

The SimpleBox displays an error with its number and the prefix "E". In addition, the present fault can be displayed in array element [-01] of parameter (P700). The last error messages are stored in parameter (P701). Further information about the frequency inverter status at the moment of the fault can be obtained from parameters (P702) to (P706) / (P799)

If the cause of the error is no longer present, the error display in the SimpleBox flashes and the error can be acknowledged with the Enter key.

In contrast, warning messages are prefixed with "C" ("Cxxx") and cannot be acknowledged. They disappear automatically when the reason for them is no longer present or the frequency inverter has switched to the "Error" state. Display of the message is suppressed if the warning appears during parameterisation.

The present warning message can be displayed in detail at any time in array element [-02] of parameter (P700).

The reason for an existing disabled switch on cannot be displayed with the SimpleBox.

### ParameterBox display

The ParameterBox displays the messages in plain text.

## 6.2 Diagnostic LEDs on device

The device generates operating status messages. These messages (warnings, errors, switching statuses, measurement data) can be displayed with parametrisation tools (📖 Section 3.1 "Control and parametrisation options ") (Parameter group P7xx).

To a limited extent, the messages are also indicated via the diagnostic and status LEDs.

### Diagnostic LEDs

LED			Status signal <sup>1)</sup>		Meaning
Name	Colour	Description			
DS	red/green	Device status	Off		Device not ready for operation • No control voltage
			green on		Device ready for operation
			green flashing	0.5 Hz	Device ready for switching on
				4 Hz	Device in switch-on block
			red/green Alternating	4 Hz	Warning
			green on + red flashing	1..25 Hz	Degree of overload of switched-on device
					Device not ready for operation
red flashing		Error, flashing frequency represents error number			
ASi	red/green	Status of AS-i			Details (📖 Section 4.5.4.2 "Displays")

1) Signal status = specification of LED colour + flashing frequency (switch-on frequency per second), example "red flashes, 2 Hz" = red LED switches on and off 2x per second

### 6.3 Messages

#### Error messages

Display in the SimpleBox / ControlBox		Fault Text in the ParameterBox	Cause • Remedy
Group	Details in P700 [-01] / P701		
E001	<b>1.0</b>	<b>Overtemp. Inverter</b> <i>"Inverter overtemperature"</i> (inverter heat sink)	Inverter temperature monitoring measurements are outside of the permissible temperature range, i.e. the error is triggered if the permissible lower limit is undershot or the permissible upper temperature limit is exceeded.
	<b>1.1</b>	<b>Overtemp. FI internal</b> <i>"Internal FI overtemperature"</i> (interior of FI)	<ul style="list-style-type: none"> <li>• Depending on the cause: Reduce or increase the ambient temperature</li> <li>• Check the FI fan / control cabinet ventilation</li> <li>• Check the FI for dirt</li> </ul>
E002	<b>2.0</b>	<b>Overtemp. Motor PTC</b> <i>"Overtemperature motor thermistor "</i>	Motor temperature sensor (PTC) has triggered <ul style="list-style-type: none"> <li>• Reduce motor load</li> <li>• Increase motor speed</li> <li>• Use external motor fan</li> </ul>
	<b>2.1</b>	<b>Overtemp. Motor I<sup>2</sup>t</b> <i>"Motor overtemperature I<sup>2</sup>t"</i>  <u>Only</u> if I <sup>2</sup> t motor (P535) is programmed.	I <sup>2</sup> t motor has triggered (calculated overtemperature of motor) <ul style="list-style-type: none"> <li>• Reduce motor load</li> <li>• Increase motor speed</li> </ul>
	<b>2.2</b>	<b>Overtemp. Brake r.ext</b> <i>"Overtemperature of external brake resistor "</i>  Overtemperature via digital input (P420 [...])={13}	Temperature monitor (e.g. brake resistor) has activated <ul style="list-style-type: none"> <li>• Digital input is Low</li> <li>• Check connection, temperature sensor</li> </ul>
E003	<b>3.0</b>	<b>I<sup>2</sup>t overcurrent limit</b>	a.c. inverter: I <sup>2</sup> t limit has triggered, e.g. > 1.5 x I <sub>n</sub> for 60s (also note P504) <ul style="list-style-type: none"> <li>• Continuous overload at inverter output</li> <li>• Possible encoder fault (resolution, defect, connection)</li> </ul>
	<b>3.1</b>	<b>Chopper overtemperature I<sup>2</sup>t</b>	Brake chopper: I <sup>2</sup> t limit has activated, 1.5 times values reached for 60s (please also pay attention to P554, if present, and P555, P556, P557) <ul style="list-style-type: none"> <li>• Avoid overcurrent in brake resistance</li> </ul>
	<b>3.2</b>	<b>IGBT overcurrent</b> 125% monitoring	De-rating (power reduction) <ul style="list-style-type: none"> <li>• 125% overcurrent for 50ms</li> <li>• Brake chopper current too high</li> <li>• for fan drives: enable flying start circuit (P520)</li> </ul>
	<b>3.3</b>	<b>IGBT overcurrent fast</b> 150% monitoring	De-rating (power reduction) <ul style="list-style-type: none"> <li>• 150% overcurrent</li> <li>• Brake chopper current too high</li> </ul>

E004	<b>4.0</b>	<b>Overcurrent module</b>	Error signal from module (short duration) <ul style="list-style-type: none"> <li>• Short-circuit or earthing fault at FI output</li> <li>• Motor cable is too long</li> <li>• Use external output choke</li> <li>• Brake resistor faulty or resistance too low</li> </ul> <p>→ <b>Do not shut off P537!</b></p> <p><b>The occurrence of a fault can significantly shorten the service life of the device, or even destroy it.</b></p>
	<b>4.1</b>	<b>Overcurrent measurement</b> <i>"Overcurrent measurement"</i>	P537 (pulse current switch-off) was reached 3x within 50 ms (only possible if P112 and P536 are disabled) <ul style="list-style-type: none"> <li>• FI is overloaded</li> <li>• Drive sluggish, insufficiently sized</li> <li>• Ramps (P102/P103) too steep -&gt; Increase ramp time</li> <li>• Check motor data (P201 ... P209)</li> </ul>
E005	<b>5.0</b>	<b>Overvoltage Ud</b>	Link circuit voltage too high <ul style="list-style-type: none"> <li>• Increase deceleration time (P103)</li> <li>• Possibly set shutdown mode (P108) with delay (not for lifting equipment)</li> <li>• Extend the quick stop time (P426)</li> <li>• Speed fluctuation (for example due to high inertia loads) → if necessary set the &lt;math&gt;\langle U/f \rangle&lt;/math&gt; characteristic curve (P211, P212)</li> </ul> FIs with brake chopper: <ul style="list-style-type: none"> <li>• Dissipate energy feedback with a braking resistor</li> <li>• Check the function of the braking resistor (cable break)</li> <li>• Resistance of connected braking resistor too high</li> </ul>
	<b>5.1</b>	<b>Mains high voltage</b>	Mains voltage too high <ul style="list-style-type: none"> <li>• See Technical Data (📖 Section 7.2 "Electrical data")</li> </ul>
E006	---	<b>Reserved</b>	
E007	<b>7.0</b>	<b>Mains Phase Failure</b>	Error at mains connection side <ul style="list-style-type: none"> <li>• A mains phase is not connected</li> <li>• Mains asymmetrical</li> </ul>
	<b>7.1</b>	<b>Phasefailure dc-link</b>	DC link voltage too low <ul style="list-style-type: none"> <li>• A mains phase is not connected</li> <li>• Load temporarily too high</li> </ul>
E008	<b>8.0</b>	<b>Parameter loss</b> (maximum EEPROM value exceeded)	Error in EEPROM data <ul style="list-style-type: none"> <li>• Software version of the stored data set not compatible with the software version of the FI.</li> </ul> <p><b>NOTE:</b> <u>Faulty parameters</u> are automatically reloaded (default data).</p> <ul style="list-style-type: none"> <li>• EMC interferences (see also E020)</li> </ul>
	<b>8.1</b>	<b>Inverter type incorrect</b>	<ul style="list-style-type: none"> <li>• EEPROM faulty</li> </ul>
	<b>8.2</b>	<b>Reserved</b>	
	<b>8.3</b>	<b>EEPROM KSE error</b> (Customer unit incorrectly identified (customer's interface equipment))	The upgrade level of the frequency inverter was not correctly identified. <ul style="list-style-type: none"> <li>• Switch mains voltage off and on again.</li> </ul>
	<b>8.4</b>	<b>Internal EEPROM error</b> (Database version incorrect)	

	8.7	EEPR copy not the same	
E009	---	Reserved	
E010	10.0	<b>Bus Timeout</b>	Telegram time-out / Bus off 24V int. CANbus <ul style="list-style-type: none"> <li>Data transfer is faulty. Check P513.</li> <li>Check physical bus connections</li> <li>Check bus protocol program process.</li> <li>Check Bus Master.</li> <li>Check 24V supply of internal CAN/CANopen Bus.</li> <li>Node guarding error (internal CANopen)</li> <li><i>Bus Off</i> error (internal CANbus)</li> </ul>
	10.2	<b>Bus Timeout Option</b>	Telegram timeout <ul style="list-style-type: none"> <li>Telegram transfer is faulty.</li> <li>Check physical bus connections</li> <li>Check bus protocol program process.</li> <li>Check Bus Master.</li> <li>PLC is in the "STOP" or "ERROR" state.</li> </ul>
	10.4	<b>Init error Option</b>	Initialisation error in bus module <ul style="list-style-type: none"> <li>Check Bus module current supply.</li> <li>DIP switch setting of a connected I/O extension module is incorrect</li> </ul>
	10.1	<b>System error option</b>	System error bus module <ul style="list-style-type: none"> <li>Further details can be found in the respective additional bus instructions.</li> </ul>
	10.3		
	10.5		<u>I/O extension:</u>
	10.6		<ul style="list-style-type: none"> <li>Incorrect measurement of the input voltage or undefined provision of the output voltage due to error in reference voltage generation.</li> <li>Short circuit at analogue output</li> </ul>
	10.7		
	10.9	<b>Module missing / P120</b>	The module entered in parameter (P120) is not available. <ul style="list-style-type: none"> <li>Check connections</li> </ul>
E011	11.0	<b>Customer terminal</b>	A/D converter error Internal control terminal (internal data bus) incorrect or interference due to radio radiation (EMC). <ul style="list-style-type: none"> <li>Check control connections for short circuit.</li> <li>Minimise EMC interferences by separate routing of control and power cables.</li> <li>Earth devices and shields well.</li> </ul>
E012	12.0	<b>External watchdog</b>	The Watchdog function is selected at a digital input and the impulse at the corresponding digital input is not present for longer than the time set in parameter P460 >Watchdog time<. <ul style="list-style-type: none"> <li>Check connections</li> <li>Check setting P460</li> </ul>
	12.1	<b>Limit moto./Customer</b> <i>"Drive switch-off limit"</i>	The drive switch-off limit (P534 [-01]) has triggered. <ul style="list-style-type: none"> <li>Reduce load on motor</li> <li>Set higher value in (P534 [-01]).</li> </ul>
	12.2	<b>Limit gen.</b> <i>"Generator switch-off limit"</i>	The generator switch-off limit (P534 [-02]) has triggered. <ul style="list-style-type: none"> <li>Reduce load on motor</li> <li>Set higher value in (P534 [-02]).</li> </ul>

	<b>12.3</b>	<b>Torque limit</b>	Limit from potentiometer or setpoint source has switched off. P400 = 12
	<b>12.4</b>	<b>Current limit</b>	Limit from potentiometer or setpoint source has switched off. P400 = 14
	<b>12.5</b>	<b>Load monitor</b>	Switch-off due to overshooting or undershooting of permissible load torques ((P525) ... (P529)) for the time set in (P528). <ul style="list-style-type: none"> <li>• Adjust load.</li> <li>• Change limit values ((P525) ... (P527)).</li> <li>• Increase delay time (P528).</li> <li>• Change monitoring mode (P529).</li> </ul>
	<b>12.8</b>	<b>AI minimum</b> <i>„Analogue In minimum“</i>	Switch-off due to undershooting of the 0% adjustment value (P402) with setting (P401) "0-10V with switch-off on error 1" or "...2"
	<b>12.9</b>	<b>AI maximum</b> <i>„Analogue In maximum“</i>	Switch-off due to overshooting of the 100% adjustment value (P402) with setting (P401) "0-10V with switch-off on error 1" or "...2"
E013	<b>13.2</b>	<b>Shut-down monitoring</b>	The slip error monitoring was triggered; the motor could not follow the setpoint. <ul style="list-style-type: none"> <li>• Check motor data P201-P209! (important for current controllers)</li> <li>• Check motor circuit</li> <li>• Check encoder settings P300 and following in servo mode</li> <li>• Increase setting value for torque limit in P112</li> <li>• Increase setting value for current limit in P536</li> <li>• Check deceleration time P103 and extend if necessary</li> </ul>
E015	---	<b>Reserved</b>	
E016	<b>16.0</b>	<b>Motor phase error</b>	A motor phase is not connected. <ul style="list-style-type: none"> <li>• Check P539</li> <li>• Check motor connection</li> </ul>
	<b>16.1</b>	<b>Magnetisation current monitoring</b> <i>"Magnetisation current monitoring"</i>	Required exciting current not achieved at moment of switch-on. <ul style="list-style-type: none"> <li>• Check P539</li> <li>• Check motor connection</li> </ul>
E019	<b>19.0</b>	<b>Parameter identification</b> <i>"Parameter identification"</i>	Automatic identification of the connected motor was unsuccessful <ul style="list-style-type: none"> <li>• Check motor connection</li> <li>• Check preset motor data (P201 ... P209)</li> <li>• PMSM – CFC Closed Loop Operation: Rotor position of motor incorrect in relation to incremental encoder Perform determination of rotor position (initial enable after a "Mains on" only with motor stationary (P330)</li> </ul>
	<b>19.1</b>	<b>Star / Delta circuit incorrect</b> <i>"Motor star / delta circuit incorrect"</i>	
E020	<b>20.0</b>	<b>Reserved</b>	System error in program execution, triggered by EMC interference. <ul style="list-style-type: none"> <li>• Observe wiring guidelines</li> <li>• Use additional external mains filter.</li> <li>• FI must be very well earthed.</li> </ul>
E021	<b>20.1</b>	<b>Watchdog</b>	
	<b>20.2</b>	<b>Stack overflow</b>	
	<b>20.3</b>	<b>Stack underflow</b>	
	<b>20.4</b>	<b>Undefined opcode</b>	



20.5	<b>Protected Instruct.</b> <i>"Protected Instruction"</i>	
20.6	<b>Illegal word access</b>	
20.7	<b>Illegal Inst. Access</b> <i>"Illegal instruction access"</i>	
20.8	<b>Program memory error</b> <i>"Program memory error"</i> (EEPROM error)	
20.9	<b>Dual-ported RAM</b>	
21.0	<b>NMI error</b> (Not used by hardware)	
21.1	<b>PLL error</b>	
21.2	<b>ADU error "Overrun"</b>	
21.3	<b>PMI error "Access Error"</b>	
21.4	<b>Userstack overflow</b>	
E022	---	<b>Reserved</b> Error message for PLC → see supplementary instructions <a href="#">BU 0550</a>
E023	---	<b>Reserved</b> Error message for PLC → see supplementary instructions <a href="#">BU 0550</a>
E024	---	<b>Reserved</b> Error message for PLC → see supplementary instructions <a href="#">BU 0550</a>

### Warning messages

Display in the SimpleBox / ControlBox		Warning Text in the ParameterBox	Cause • Remedy
Group	Details in P700 [-02]		
C001	1.0	<b>Overtemp. Inverter</b> <i>"Inverter overtemperature"</i> (inverter heat sink)	Inverter temperature monitoring Warning: permissible temperature limit reached. <ul style="list-style-type: none"> <li>• Reduce ambient temperature</li> <li>• Check the FI fan / control cabinet ventilation</li> <li>• Check the FI for dirt</li> </ul>
C002	2.0	<b>Motor overtemp. PTC</b> <i>"Motor overtemp. PTC"</i>	Warning from the motor temperature sensor (trigger limit reached) <ul style="list-style-type: none"> <li>• Reduce motor load</li> <li>• Increase motor speed</li> <li>• Use external motor fan</li> </ul>
	2.1	<b>Motor overtemp. I<sup>2</sup>t</b> <i>"Motor overtemperature I<sup>2</sup>t"</i>  <u>Only</u> if I <sup>2</sup> t motor (P535) is programmed.	Warning: I <sup>2</sup> t motor monitoring (1.3x the rated current reached for the time period set in (P535)) <ul style="list-style-type: none"> <li>• Reduce motor load</li> <li>• Increase motor speed</li> </ul>
	2.2	<b>External braking resistor overtemperature</b> <i>"External braking resistor overtemperature"</i>	Warning: Temperature sensor (e.g. braking resistor) has triggered <ul style="list-style-type: none"> <li>• Digital input is low</li> </ul>

		Overtemperature via digital input (P420 [...])={13}	
C003	3.0	<b>Overcurrent, I<sup>2</sup>t limit</b>	Warning: Inverter: I <sup>2</sup> t limit has triggered, e.g. > 1.3 x I <sub>n</sub> for 60s (please also note P504) <ul style="list-style-type: none"> <li>• Continuous overload at FI output</li> </ul>
	3.1	<b>Overcurrent, chopper I<sup>2</sup>t</b>	Warning: I <sup>2</sup> t limit for the brake chopper has triggered, 1.3x value attained for 60s (also note P554, if present, as well as P555, P556, P557) <ul style="list-style-type: none"> <li>• Avoid overload of brake resistance</li> </ul>
	3.5	<b>Torque current limit</b>	Warning: Torque current limit reached <ul style="list-style-type: none"> <li>• Check (P112)</li> </ul>
	3.6	<b>Current limit</b>	Warning: Current limit reached <ul style="list-style-type: none"> <li>• Check (P536)</li> </ul>
C004	4.1	<b>Overcurrent measurement</b> "Overcurrent measurement"	Warning: pulse switch off is active The limit for activation of pulse switch off (P537) has been reached (only possible if P112 and P536 are switched off) <ul style="list-style-type: none"> <li>• FI is overloaded</li> <li>• Drive sluggish, insufficiently sized</li> <li>• Ramps (P102/P103) too steep -&gt; Increase ramp time</li> <li>• Check motor data (P201 ... P209)</li> <li>• Switch off slip compensation (P212)</li> </ul>
C008	8.0	<b>Parameter loss</b>	Warning: One of the cyclically saved messages such as <i>operating hours</i> or <i>enabling time</i> could not be saved successfully.  The warning disappears as soon as saving can be successfully performed.
C012	12.1	<b>Limit moto./Customer</b> "Drive switch-off limit"	Warning: 80 % of the drive switch-off limit (P534 [-01]) has been exceeded. <ul style="list-style-type: none"> <li>• Reduce load on motor</li> <li>• Set higher value in (P534 [-01]).</li> </ul>
	12.2	<b>Limit gen.</b> "Generator switch-off limit"	Warning: 80 % of the generator switch-off limit (P534 [-02]) has been reached. <ul style="list-style-type: none"> <li>• Reduce load on motor</li> <li>• Set higher value in (P534 [-02]).</li> </ul>
	12.3	<b>Torque limit</b>	Warning: 80 % of the limit from the potentiometer or the setpoint source has been reached. P400 = 12
	12.4	<b>Current limit</b>	Warning: 80 % of the limit from the potentiometer or the setpoint source has been reached. P400 = 14
	12.5	<b>Load monitor</b>	Warning due to overshooting or undershooting of permissible load torques ((P525) ... (P529)) for the time set in (P528). <ul style="list-style-type: none"> <li>• Adjust load.</li> <li>• Change limit values ((P525) ... (P527)).</li> <li>• Increase delay time (P528).</li> </ul>

### Switch-on block messages

Display in the SimpleBox / ControlBox		Reason: Text in the ParameterBox	Cause • Remedy
Group	Details in P700 [-03]		
I000	0.1	<b>Disable voltage from IO</b>	If the function "disable voltage" is parameterised, input (P420 / P480) is at Low <ul style="list-style-type: none"> <li>• Set "input High"</li> <li>• Check signal cable (broken cable)</li> </ul>
	0.2	<b>IO fast stop</b>	If the function "fast stop" is parameterised, input (P420 / P480) is at Low <ul style="list-style-type: none"> <li>• Set "input High"</li> <li>• Check signal cable (broken cable)</li> </ul>
	0.3	<b>Block voltage from bus</b>	<ul style="list-style-type: none"> <li>• For bus operation (P509): control word Bit 1 is "Low"</li> </ul>
	0.4	<b>Bus fast stop</b>	<ul style="list-style-type: none"> <li>• For bus operation (P509): control word Bit 2 is "Low"</li> </ul>
	0.5	<b>Enable on start</b>	Enable signal (control word, Dig I/O or Bus I/O) was already applied during the initialisation phase (after mains "ON", or control voltage "ON"). Or electrical phase is missing. <ul style="list-style-type: none"> <li>• Only issue enable signal after completion of initialisation (i.e. when the FI is ready)</li> <li>• Activation of "Automatic Start" (P428)</li> </ul>
	0.6 – 0.7	<b>Reserved</b>	Information message for PLC → see supplementary instructions
	0.8	<b>Right direction blocked</b>	Switch-on block with inverter shut-off activated by: <b>P540</b> or by "Enable right block" ( <b>P420</b> = 31, 73) or "Enable left block" ( <b>P420</b> = 32, 74),  The frequency inverter switches to "Ready for switching on" status
	0.9	<b>Left direction blocked</b>	
	I006 <sup>1)</sup>	6.0	<b>Charging error</b>
I011	11.0	<b>Analog Stop</b>	If an analog input of the frequency inverter or a connected IO extension is configured to detect cable breaks (2-10V signal or 4-20mA signal), the frequency inverter switches to the status "ready for switch-on" if the analog signal undershoots the value <b>1 V</b> or <b>2 mA</b>  This also occurs if the relevant analog input is parameterised to function "0" ("no function"). <ul style="list-style-type: none"> <li>• Check connections</li> </ul>

1) Indication of operating mode (message) on the *ParameterBox* or virtual operating unit of the *NORD CON-Software*: "Not ready"

## 6.4 FAQ operational problems

Fault	Possible cause	Remedy
Device will not start (all LEDs off)	<ul style="list-style-type: none"> <li>No mains voltage or wrong mains voltage</li> </ul>	<ul style="list-style-type: none"> <li>Check connections and supply cables</li> <li>Check switches / fuses</li> </ul>
Device does not react to enabling	<ul style="list-style-type: none"> <li>Control elements not connected</li> <li>Incorrect control word source setting</li> <li>Right and left enable signals present simultaneously</li> <li>Enable signal present before device ready for operation (device expecting a 0 → 1 edge)</li> </ul>	<ul style="list-style-type: none"> <li>Reset enable</li> <li>Change over <b>P428</b> if necessary: "0" = device expecting a 0→1 edge for enable / "1" = device reacts to "Level" → <b>Danger: Drive can start up independently!</b></li> <li>Check control connections</li> <li>Check <b>P509</b></li> </ul>
Motor will not start in spite of enable being present	<ul style="list-style-type: none"> <li>Motor cables not connected</li> <li>Brake not ventilating</li> <li>No setpoint specified</li> <li>Incorrect setpoint source setting</li> </ul>	<ul style="list-style-type: none"> <li>Check connections and supply cables</li> <li>Check control elements</li> <li>Check <b>P510</b></li> </ul>
Device switches off without error message when load increases (increased mechanical load / speed)	<ul style="list-style-type: none"> <li>Mains phase missing</li> </ul>	<ul style="list-style-type: none"> <li>Check connections and supply cables</li> <li>Check switches / fuses</li> </ul>
Motor rotates in the wrong direction	<ul style="list-style-type: none"> <li>Motor cable: U-V-W incorrectly connected</li> </ul>	<ul style="list-style-type: none"> <li>Motor cable: Change 2 phases</li> <li>Alternative: <ul style="list-style-type: none"> <li>– Check motor phase sequence (<b>P583</b>)</li> <li>– Change Enable right/left functions (<b>P420</b>)</li> <li>– Change control word Bit 11/12 (for bus control)</li> </ul> </li> </ul>
Motor not reaching required speed	<ul style="list-style-type: none"> <li>Maximum frequency parameter setting too low</li> </ul>	<ul style="list-style-type: none"> <li>Check <b>P105</b></li> </ul>

<p>Motor speed does not correspond to the setpoint specification</p>	<ul style="list-style-type: none"> <li>• Analogue input function set to "Frequency addition". Another setpoint is present.</li> </ul>	<ul style="list-style-type: none"> <li>• Check <b>P400</b></li> <li>• <b>P420</b>, check active fixed frequencies</li> <li>• Check bus setpoints</li> <li>• <b>P104/ P105</b> Check "Min/ max. -frequency"</li> <li>• <b>P113</b> Check "Jog frequency"</li> </ul>
<p>Intermittent communication error between FI and option modules</p>	<ul style="list-style-type: none"> <li>• System bus terminating resistor not set</li> <li>• Poor connection contacting</li> <li>• Interference on system bus line</li> <li>• Maximum system bus length exceeded</li> </ul>	<ul style="list-style-type: none"> <li>• First and last subscriber only: Set DIP switches for terminating resistance</li> <li>• Check connections</li> <li>• Connect GND of all FI connected to system bus</li> <li>• Pay attention to routing regulations (separate routing of signal and control cables and mains and motor cables)</li> <li>• Check cable lengths (system bus)</li> </ul>

Table 12: FAQ operational problems

## 7 Technical data

### 7.1 General data for frequency inverter

Function	Specification
Output frequency	0.0 ... 400.0 Hz
Pulse frequency	3.0 ... 16.0 kHz, factory setting = 6 kHz Power reduction > 8 kHz with 115 / 230 V device, > 6 kHz with 400 V device
Typical overload capacity	150% for 60 s, 200% for 3.5 s
Efficiency	> 95% according to size
Insulation resistance	> 10 MΩ
Operating / ambient temperature	-25 °C ... +40 °C, for detailed information (including UL-values) on individual device types and operating modes, see (chapter 7.2). ATEX: -20...+40 °C (chapter 2.5)
Storage and transport temperature	-25 °C ... +60/70 °C
Long-term storage	(chapter 9)
Protection class	IP55, optionally IP66 (chapter 1.9) NEMA1, higher NEMA classifications on request
Max. installation altitude above sea level	<i>up to 1000 m</i> No power reduction  <i>1000...2000 m:</i> 1% / 100 m power reduction, overvoltage category 3  <i>2000...4000 m:</i> 1% / 100 m power reduction, overvoltage category 2, external overvoltage protection required at mains input
Ambient conditions	<i>Transport (IEC 60721-3-2):</i> Mechanical: 2M2 <i>Operation (IEC 60721-3-3):</i> Mechanical: 3M7 Climatic: 3K3 (IP55) 3K4 (IP66)
Environmental protection	<i>Energy-saving function</i> (chapter 8.7), Siehe P219 <i>EMC</i> (chapter 8.3) <i>RoHS</i> (chapter 1.6)
Protective measures against	Overtemperature of the frequency inverter Short circuit, ground fault, overload, idle running Overvoltage and undervoltage
Motor temperature monitoring	I <sup>2</sup> t motor, PTC/bimetallic switch
Regulation and control	Sensorless current vector control (ISD), linear V/f characteristic curve, VFC open-loop, CFC open-loop
Waiting period between two mains switch-on cycles	60 s for all devices in normal operating cycle
Interfaces	<i>Standard</i> RS485 (USS) (for parameterisation units only) RS232 (single slave) System bus <i>Option</i> AS-i on board (chapter 4.5) Various bus modules (chapter 1.3)
Electrical isolation	Control terminals
Connection terminals, electrical connection	<i>Power unit</i> (chapter 2.4.2) <i>Control unit</i> (chapter 2.4.3)

## 7.2 Technical data for determining the energy efficiency level

The following tables relate to the provisions of the Ecodesign EU Regulation 2019/1781.

Manufacturer	FI type	Rel. losses (rel. motor stator frequency / rel. torque-producing current)								Standby	IE rating
		90/100	90/50	50/100	50/50	50/25	0/100	0/50	0/25		
Getriebebau NORD GmbH & Co. KG	SK 1x0E-	[%]	[%]	[%]	[%]	[%]	[%]	[%]	[%]	[W]	
	250-323	4,6	4,0	4,2	3,8	3,7	3,9	3,6	3,6	5,0	IE2
	370-323	4,0	3,3	3,6	3,1	3,0	3,2	2,9	2,9	5,0	IE2
	550-323	3,7	2,9	3,2	2,7	2,6	2,9	2,6	2,6	5,0	IE2
	750-323	3,2	2,4	2,8	2,3	2,2	2,5	2,1	2,1	4,6	IE2
	111-323	3,2	2,2	2,7	2,0	1,7	2,3	1,8	1,6	4,6	IE2
	151-323	2,9	1,9	2,4	1,7	1,5	2,1	1,6	1,4	4,6	IE2
	250-340	6,1	5,3	5,5	5,1	5,0	5,2	5,0	5,0	5,7	IE2
	370-340	5,8	5,0	5,2	4,8	4,7	4,9	4,6	4,6	5,7	IE2
	550-340	4,1	3,3	3,6	3,1	3,0	3,3	3,0	3,0	5,5	IE2
	750-340	3,7	2,9	3,1	2,7	2,6	2,8	2,5	2,5	5,5	IE2
	111-340	3,5	2,4	2,8	2,2	1,9	2,5	2,1	1,9	5,5	IE2
	151-340	3,4	2,4	2,9	2,2	1,9	2,5	2,1	1,9	5,1	IE2
221-340	3,4	2,2	2,8	2,0	1,8	2,5	1,9	1,7	5,1	IE2	

Manufacturer	FI type	Output power	Indicative output power	Rated output current	Max. operating temperature	Rated input frequency	Rated input voltage range
Getriebebau NORD GmbH & Co. KG	SK 1x0E-	[kVA]	[kW]	[A]	[°C]	[Hz]	[V]
	250-323	0,5	0,25	1,31	40	50	200 V – 240 V
	370-323	0,7	0,37	1,83	40	50	200 V – 240 V
	550-323	1,0	0,55	2,56	40	50	200 V – 240 V
	750-323	1,3	0,75	3,39	40	50	200 V – 240 V
	111-323	1,7	1,10	4,49	40	50	200 V – 240 V
	151-323	2,3	1,50	6,02	40	50	200 V – 240 V
	250-340	0,5	0,25	0,76	40	50	380 V – 480 V
	370-340	0,7	0,37	1,06	40	50	380 V – 480 V
	550-340	1,0	0,55	1,48	40	50	380 V – 480 V
	750-340	1,3	0,75	1,96	40	50	380 V – 480 V
	111-340	1,7	1,10	2,60	40	50	380 V – 480 V
	151-340	2,3	1,50	3,48	40	50	380 V – 480 V
221-340	3,3	2,20	5,02	40	50	380 V – 480 V	

### 7.3 Electrical data

The following table lists the electrical data for frequency inverters. The details based on measurement series for the operating modes are for orientation purposes and may deviate in practice. The measurement series were made at the rated speed with 4-pole NORD standard motors

The following factors have a particular influence on the determined limiting values:

#### Wall mounted

- Installation location
- Influence from adjacent devices
- Additional air currents

and also with

#### Motor Mounted

- Type of motor used,
- Size of motor used
- Speed with internally ventilated motors
- Use of external fans.



#### Information

#### Single phase operation

For single phase operation (115 / 230 V) the mains impedance must be at least 100  $\mu$ H for each conductor. If this is not the case, a mains choke must be installed.

Failure to comply with this may cause damage to the device due to impermissible currents in the components.



#### Information

#### Information about current and power

The powers stated for the operating modes are only a rough categorisation

The current values are more reliable details for the selection of the correct frequency inverter/motor combination!

The following tables contain the data which is relevant for UL (please see chapter 1.6.1 "UL and CSA approval").



**7.3.1 Electrical data 1~ 115 V**

Device type	SK 1x0E...	-250-112-	-370-112-	-550-112-	-750-112-	
	Size	1	1	1	1	
Nominal motor power (4-pole standard motor)	230 V	0.25 kW	0.37 kW	0.55 kW	0.75 kW	
	240 V	1/3 hp	1/2 hp	3/4 hp	1 hp	
Mains voltage	<b>115 V</b>	<b>1 AC 110 ... 120 V, ± 10%, 47 ... 63 Hz</b>				
Input current	rms	9.1 A	11.0 A	14.3 A	18.4 A	
	FLA	9.1 A	11.0 A	14.3 A	18.4 A	
Output voltage	<b>230 V</b>	<b>3 AC 0 ... 2 times mains voltage</b>				
Output current <sup>1)</sup>	rms	1.7 A	2.1 A	3.0 A	3.7 A	
	FLA motor mounting	1.7 A	2.1 A	3.0 A (S1-40°C)	3.7 A (S1-40°C)	
	FLA wall mounting	1.7 A	2.1 A	3.0 A (S1-40°C)	3.7 A <sup>a)</sup> (S1-20°C)	
<b>Motor-mounted (ventilated)</b>						
Max. continuous power / max. continuous current:						
	S1-50°C	0.25 kW / 1.7 A	0.37 kW / 2.1 A	0.55 kW / 2.6 A	0.55 kW / 2.9 A	
	S1-40°C	0.25 kW / 1.7 A	0.37 kW / 2.1 A	0.55 kW / 3.0 A	0.75 kW / 3.7 A	
Max. permissible ambient temp. with nominal output current						
S1		50°C	50°C	40°C	40°C	
S3 70% ED 10 min		50°C	50°C	50°C	50°C	
S6 70% ED 10 min (100% / 20% Mn)		50°C	50°C	50°C	50°C	
<b>Wall mounting (unventilated)</b>						
Max. continuous power / max. continuous current						
	S1-50°C	0.25 kW / 1.7 A	0.37 kW / 2.1 A	0.55 kW / 3.0 A	0.55 kW / 2.7 A	
	S1-40°C	0.25 kW / 1.7 A	0.37 kW / 2.1 A	0.55 kW / 3.0 A	0.75 kW / 3.4 A	
Max. permissible ambient temp. with nominal output current						
S1		50°C	50°C	40°C	35°C	
S3 70% ED 10 min		50°C	50°C	50°C	45°C	
S6 70% ED 10 min (100% / 20% Mn)		50°C	50°C	50°C	45°C	
		<b>General fuses (AC) (recommended)</b>				
slow-blowing		16 A	16 A	16 A	25 A	
		<b>UL fuses (AC) – permitted</b>				
		Isc <sup>2)</sup> [A]				
		Class				
		10 000	65 000	100 000		
Fuse <sup>3)</sup>	RK5	(x)	x	30 A	30 A	30 A
	CC, J, R, T, G, L	(x)	x	30 A	30 A	30 A
CB <sup>4)</sup>	(≥ 115 V)		x	30 A	30 A	30 A

1) FLA motor installation: relates to a motor with fan

2) Maximum permissible mains overload current

3) The use of a SK TU4-MSW(-...) module limits the permissible short circuit current in the mains to 10 kA

4) "inverse time trip type" in accordance with UL 489

a) FLA: 3.4 A (S1-40°C)

### 7.3.2 Electrical data 1/3~230 V

Device type	SK 1x0E...	-250-323-	-370-323-	-550-323-		
	Size	1	1	1		
Nominal motor power (4-pole standard motor)	230 V	0.25 kW	0.37 kW	0.55 kW		
	240 V	1/3 hp	1/2 hp	3/4 hp		
Mains voltage	<b>230 V</b>	1/3 AC 200 ... 240 V, ± 10%, 47 ... 63 Hz				
Input current	rms	4.5 / 3.2 A	5.7 / 3.8 A	7.2 / 4.8 A		
	FLA	4.5 / 3.2 A	5.7 / 3.8 A	7.2 / 4.8 A		
Output voltage	<b>230 V</b>	3 AC 0 ... Mains voltage				
Output current <sup>1)</sup>	rms	1.7 A	2.2 A	3.0 A		
	FLA motor mounting	1.7 A	2.2 A (S1-40°C)	2.9 A (S1-40°C)		
	FLA wall mounting	1.7 A	2.2 A (S1-40°C)	2.9 A <sup>a)</sup> (S1-25°C)		
<b>Motor-mounted (ventilated)</b>						
Max. continuous power / max. continuous current						
	S1-50°C	0.25kW / 1.7A	0.37kW / 2.2A	0.37kW / 2.2A		
	S1-40°C	0.25kW / 1.7A	0.37kW / 2.2A	0.55kW / 3.0A		
Max. permissible ambient temp. with nominal output current						
	S1	50°C	50°C	40°C		
	S3 70% ED 10 min	50°C	50°C	50°C		
	S6 70% ED 10 min (100% / 20% Mn)	50°C	50°C	50°C		
<b>Wall mounting (unventilated)</b>						
Max. continuous power / max. continuous current						
(deviating value for 1~ operation in brackets)	S1-50°C	0.25kW / 1.7A	0.37kW / 2.2A (1.9A)	0.55kW / 3.0A (2.2A)		
	S1-40°C	0.25kW / 1.7A	0.37kW / 2.2A	0.55kW / 3.0A (2.5A)		
Max. permissible ambient temp. with nominal output current						
	S1	50°C	1~ 40°C / 3~ 50°C	1~ 25°C / 3~ 40°C		
	S3 70% ED 10 min	50°C	50°C	1~ 35°C / 3~ 50°C		
	S6 70% ED 10 min (100% / 20% Mn)	50°C	50°C	1~ 35°C / 3~ 50°C		
<b>General fuses (AC) (recommended)</b>						
slow-blowing		10 A	10 A	10 A		
Class		<b>UL fuses (AC) – permitted</b>				
		Isc <sup>2)</sup> [A]	10 000	65 000	100 000	
Fuse <sup>3)</sup>	RK5	(x)	x	10 A	10 A	10 A
	CC, J, R, T, G, L	(x)	x	10 A	10 A	10 A
CB <sup>4)</sup>	(≥ 230 V)		x	10 A	10 A	10 A

1) FLA motor installation: relates to a motor with fan

2) Maximum permissible mains overload current

3) The use of a SK TU4-MSW(-...) module limits the permissible short circuit current in the mains to 10 kA

4) "inverse time trip type" in accordance with UL 489

a) FLA: 2.2 A (S1-40°C)

Device type		SK 1x0E...	-750-323-	-111-323-	-151-323-	
		Size	2	2	2	
Nominal motor power (4-pole standard motor)		230 V	0.75 kW	1.10 kW	1.5 kW	
		240 V	1 hp	1½ hp	2 hp	
Mains voltage		<b>230 V</b>	<b>1/3 AC</b>		<b>3 AC</b>	
			200 ... 240 V, ± 10%, 47 ... 63 Hz			
Input current		rms	10.6 / 7.0 A	14.0 / 9.2 A	11.2 A	
		FLA	10.6 / 7.0 A	14.0 / 9.2 A	11.2 A	
Output voltage		<b>230 V</b>	<b>3 AC 0 ... Mains voltage</b>			
Output current <sup>1)</sup>		rms	4.0 A	5.5 A	7.0 A	
		FLA motor mounting	3.9 A (S1-40°C)	5.4 A (S1-40°C)	6.9 A (S1-40°C)	
		FLA wall mounting	3.9 A (S1-40°C)	5.4 A <sup>a)</sup> (S1-30°C)	6.9 A (S1-40°C)	
Min. braking resistor	Accessories		100 Ω	100 Ω	75 Ω	
<b>Motor-mounted (ventilated)</b>						
Max. continuous power / max. continuous current:						
(deviating value for 1~ operation in brackets)		S1-50°C	0.75kW / 4.0A (3.4A)	0.75kW / 4.2A	1.1kW / 5.5A	
		S1-40°C	0.75kW / 4.0A	1.1kW / 5.4A	1.5kW / 7.0A	
Max. permissible ambient temp. with nominal output current						
S1			1~ 40°C / 3~ 50°C	40°C	40°C	
S3 70% ED 10 min			50°C	50°C	50°C	
S6 70% ED 10 min (100% / 20% Mn)			50°C	50°C	50°C	
<b>Wall mounting (unventilated)</b>						
Max. continuous power / max. continuous current:						
(deviating value for 1~ operation in brackets)		S1-50°C	0.75kW / 4.0A (3.4A)	0.75kW / 4.0A (3.6A)	1.1kW / 5.5A	
		S1-40°C	0.75kW / 4.0A	0.75kW / 4.5A (4.4A)	1.5kW / 6.5A	
Max. permissible ambient temp. with nominal output current						
S1			1~ 40°C / 3~ 45°C	1~ 30°C / 3~ 40°C	30°C	
S3 70% ED 10 min			50°C	1~ 40°C / 3~ 50°C	40°C	
S6 70% ED 10 min (100% / 20% Mn)			50°C	1~ 40°C / 3~ 50°C	40°C	
			<b>General fuses (AC) (recommended)</b>			
slow-blowing			16 A	16 A	16 A	
		Class	<b>UL fuses (AC) – permitted</b>			
			Isc <sup>2)</sup> [A]			
			10 000	65 000	100 000	
Fuse <sup>3)</sup>	RK5	(x)	x	30 A	30 A	30 A
	CC, J, R, T, G, L	(x)	x	30 A	30 A	30 A
CB <sup>4)</sup>	(≥ 230 V)		x	30 A	30 A	30 A

1) FLA motor installation: relates to a motor with fan

2) Maximum permissible mains overload current

3) The use of a SK TU4-MSW(-...) module limits the permissible short circuit current in the mains to 10 kA

4) "inverse time trip type" in accordance with UL 489

a) FLA: 4.4 A (S1-40°C)

### 7.3.3 Electrical data 3~ 400 V

Device type	SK 1x0E...	-250-340-	-370-340-	-550-340-	-750-340-	-111-340-		
	Size	1	1	1	1	1		
Nominal motor power (4-pole standard motor)	400 V	0.25 kW	0.37 kW	0.55 kW	0.75 kW	1.1 kW		
	480 V	1/3 hp	1/2 hp	3/4 hp	1 hp	1 1/2 hp		
Mains voltage	<b>400 V</b>	<b>3 AC 380 ... 480 V, - 20% / + 10%, 47 ... 63 Hz</b>						
Input current	rms	2.0 A	2.3 A	2.6 A	3.2 A	4.1 A		
	FLA	2.0 A	2.3 A	2.6 A	3.2 A	4.1 A		
Output voltage	<b>400 V</b>	<b>3 AC 0 ... Mains voltage</b>						
Output current <sup>1)</sup>	rms	1.2 A	1.5 A	1.7 A	2.3 A	3.1 A		
	FLA motor mounting	1.1 A	1.3 A	1.5 A	2.1 A	2.8 A (S1-40°C)		
	FLA wall mounting	1.1 A	1.3 A	1.5 A	2.1 A <sup>a)</sup> (S1-40°C)	2.8 A (S1-40°C)		
<b>Motor-mounted (ventilated)</b>								
Max. continuous power / max. continuous current:								
S1-50°C		0.25kW / 1.2A	0.37kW / 1.5A	0.55kW / 1.7A	0.75kW / 2.3A	0.75kW / 2.3A		
S1-40°C		0.25kW / 1.2A	0.37kW / 1.5A	0.55kW / 1.7A	0.75kW / 2.3A	1.10kW / 3.1A		
Max. permissible ambient temp. with nominal output current								
S1		50°C	50°C	50°C	50°C	40°C		
S3 70% ED 10 min		50°C	50°C	50°C	50°C	50°C		
S6 70% ED 10 min (100% / 20% Mn)		50°C	50°C	50°C	50°C	50°C		
<b>Wall mounting (unventilated)</b>								
Max. continuous power / max. continuous current:								
S1-50°C		0.25kW / 1.2A	0.37kW / 1.5A	0.55kW / 1.7A	0.75kW / 2.0A	0.75kW / 2.0A		
S1-40°C		0.25kW / 1.2A	0.37kW / 1.5A	0.55kW / 1.7A	0.75kW / 2.3A	1.10kW / 2.6A		
Max. permissible ambient temp. with nominal output current								
S1		50°C	50°C	50°C	40°C	30°C		
S3 70% ED 10 min		50°C	50°C	50°C	50°C	40°C		
S6 70% ED 10 min (100% / 20% Mn)		50°C	50°C	50°C	50°C	40°C		
<b>General fuses (AC) (recommended)</b>								
slow-blowing		10 A	10 A	10 A	10 A	10 A		
Class		<b>UL fuses (AC) – permitted</b>						
		Isc <sup>2)</sup> [A]	10 000	65 000	100 000			
Fuse <sup>3)</sup>	RK5	(x)	x	5 A	5 A	5 A	5 A	10 A
	CC, J, R, T, G, L	(x)	x	5 A	5 A	5 A	5 A	10 A
CB <sup>4)</sup>	(≥ 400 V)		x	5 A	5 A	5 A	5 A	10 A

1) FLA motor installation: relates to a motor with fan

2) Maximum permissible mains overload current

3) The use of a SK TU4-MSW(-...) module limits the permissible short circuit current in the mains to 10 kA

4) "inverse time trip type" in accordance with UL 489

a) FLA: 2.0 A (S1-50°C)

Device type	SK 1x0E...	-151-340-	-221-340-				
	Size	2	2				
Nominal motor power (4-pole standard motor)	400 V	1.5 kW	2.2 kW				
	480 V	2 hp	3 hp				
Mains voltage	<b>400 V</b>	<b>3 AC 380 ... 480 V, - 20% / + 10%, 47 ... 63 Hz</b>					
Input current	rms	6.0 A	7.0 A				
	FLA	5.7 A	7.0 A				
Output voltage	<b>400 V</b>	<b>3 AC 0 ... Mains voltage</b>					
Output current <sup>1)</sup>	rms	4.0 A	5.5 A				
	FLA motor mounting	3.6 A	4.9 A				
	FLA wall mounting	3.6 A (S1-40°C)	4.9 A <sup>a)</sup> (S1-30°C)				
Min. braking resistor	Accessories	180 Ω	130 Ω				
<b>Motor-mounted (ventilated)</b>							
Max. continuous power / max. continuous current:							
	S1-50°C	1.5kW / 4.0A	1.5kW / 4.0A				
	S1-40°C	1.5kW / 4.0A	2.2kW / 5.5A				
Max. permissible ambient temp. with nominal output current							
	S1	50°C	40°C				
	S3 70% ED 10 min	50°C	50°C				
	S6 70% ED 10 min (100% / 20% Mn)	50°C	50°C				
<b>Wall mounting (unventilated)</b>							
Max. continuous power / max. continuous current:							
	S1-50°C	1.1kW / 2.5A	1.1kW / 2.5A				
	S1-40°C	1.5kW / 3.5A	1.5kW / 3.5A				
Max. permissible ambient temp. with nominal output current							
	S1	30°C	20°C				
	S3 70% ED 10 min	40°C	30°C				
	S6 70% ED 10 min (100% / 20% Mn)	40°C	30°C				
		<b>General fuses (AC) (recommended)</b>					
slow-blowing		10 A	10 A				
		<b>UL fuses (AC) – permitted</b>					
Fuse <sup>3)</sup>	Class	Isc <sup>2)</sup> [A]					
		10 000	65 000	100 000			
	RK5	(x)	x	10 A	10 A		
	CC, J, R, T, G, L	(x)	x	10 A	10 A		
CB <sup>4)</sup>	(≥ 400 V)		x	10 A	10 A		

1) FLA motor installation: relates to a motor with fan

2) Maximum permissible mains overload current

3) The use of a SK TU4-MSW(-...) module limits the permissible short circuit current in the mains to 10 kA

4) "inverse time trip type" in accordance with UL 489

a) FLA: 4.0 A (S1-40°C)

## 8 Additional information

### 8.1 Setpoint processing

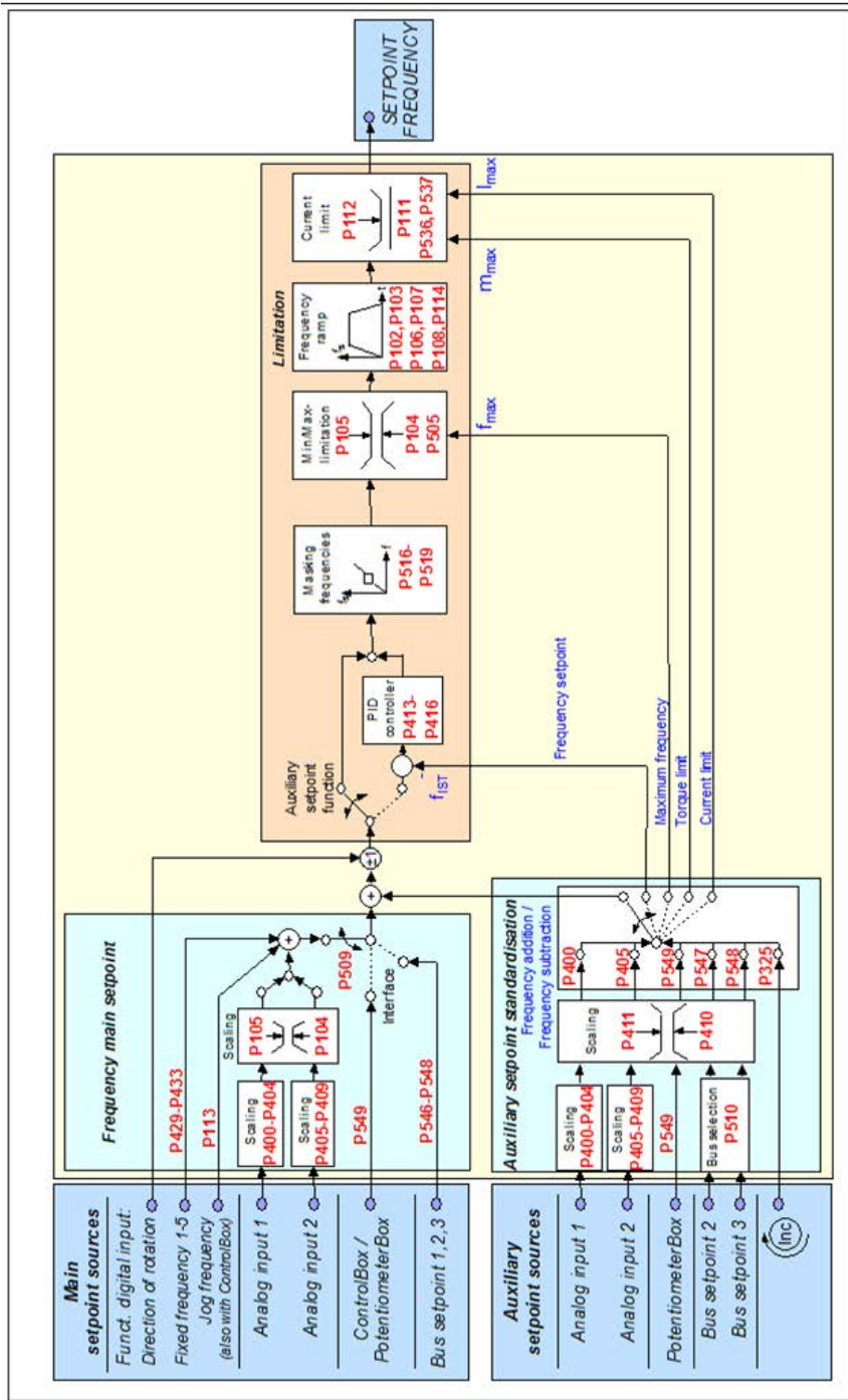

Figure 15 Setpoint processing

## 8.2 Process controller

The process controller is a PI controller which can be used to limit the controller output. In addition, the output is scaled as a percentage of a master setpoint. This provides the option of controlling any downstream drives with the master setpoint and readjusting using the PI controller.

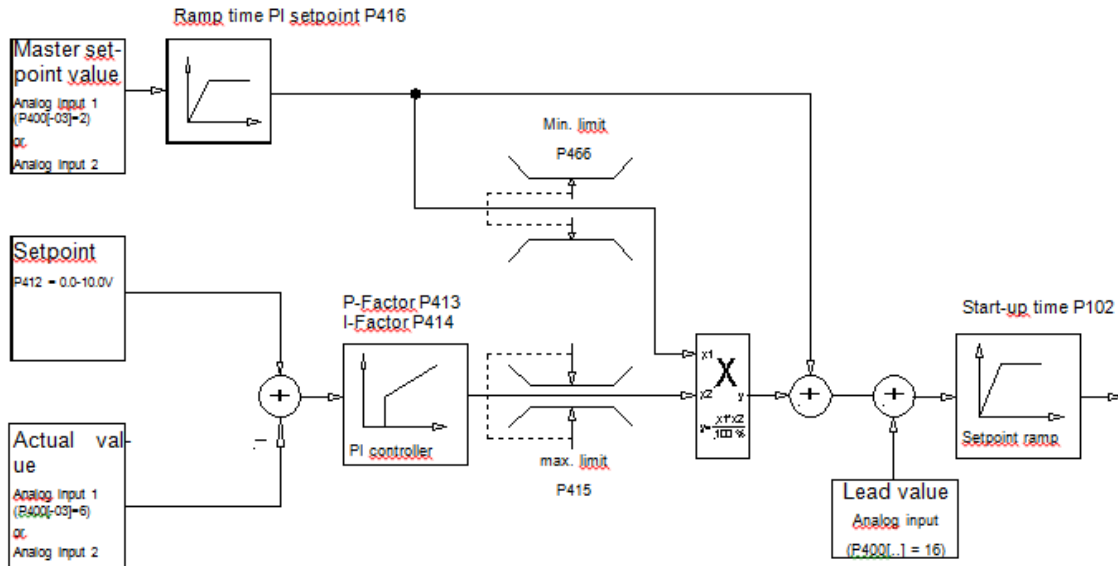
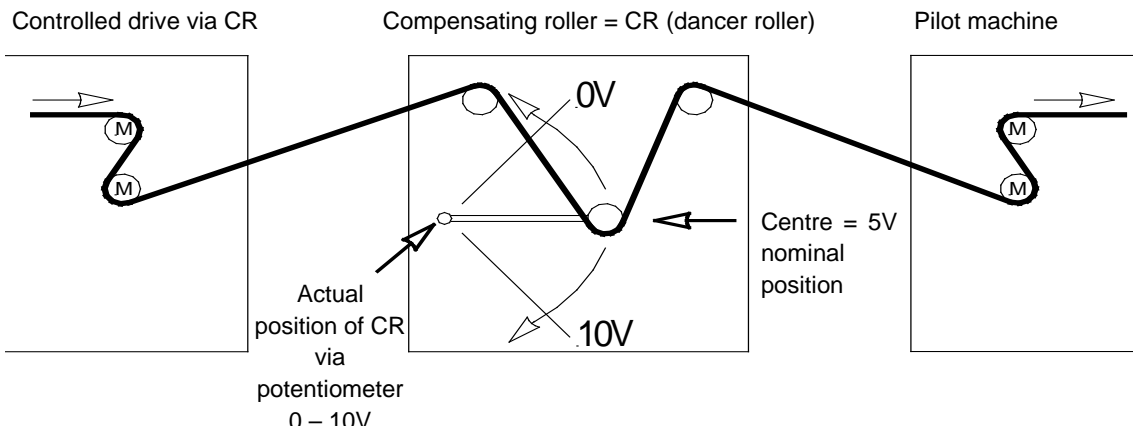
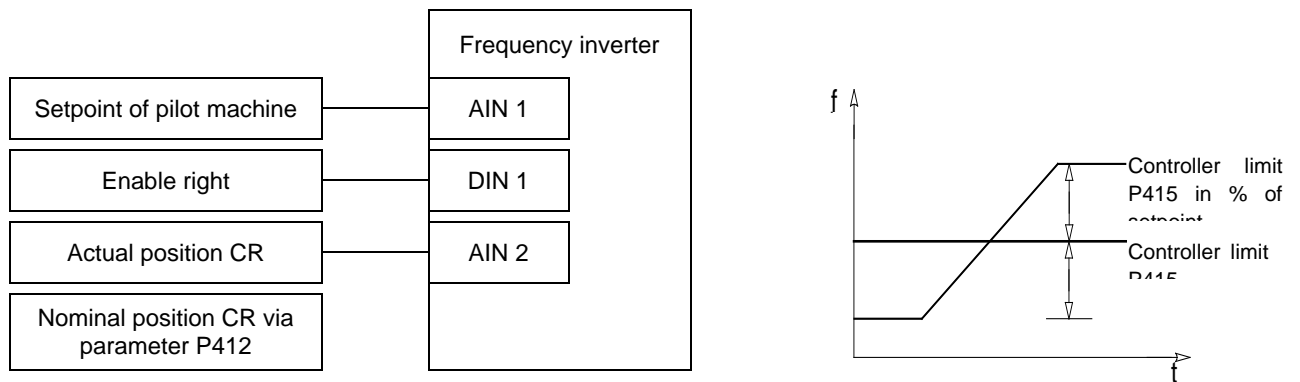

Fig.: Process controller flow-chart

Figure 16: Process controller flow diagram

### 8.2.1 Process controller application example





### 8.2.2 Process controller parameter settings

(Example: setpoint frequency: 50 Hz, control limits: +/- 25%)

P105 (maximum frequency) [Hz] :  $\geq \text{Setpoint freq. [Hz]} + \left( \frac{\text{Setpoint freq. [Hz]} \times \text{P415 [\%]}}{100\%} \right)$

Example:  $\geq 50\text{Hz} + \frac{50\text{Hz} \times 25\%}{100\%} = 62.5\text{Hz}$

P400 [-01] (Funct. Analogue input1) : "2" (frequency addition)

P411 (setpoint frequency) [Hz] : Set frequency with 10 V at analogue input 1

Example: **50 Hz**

P412 (Process controller setpoint) : CR middle position / Default setting **5V** (adjust if necessary)

P413 (P controller) [%] : Factory setting **10%** (adjust if necessary)

P414 (I-controller) [%/ms] : recommended **100%/s**

P415 (limitation +/-) [%] : Controller limitation (see above)

**Note:** Parameter P415 is used as a control limit after the PI controller.

Example: **25%** of setpoint

P416 (Ramp time PI setpoint) [s] : Factory setting **2s** (if necessary, adjust to match controller behaviour)

P420 [-01] (Funct. digital input 1) : "1" Enable right

P400 [-02] (Funct. Analogue input 2) : "6" PI process controller actual value



### **8.3 Electromagnetic compatibility (EMC)**

If the device is installed according to the recommendations in this manual, it meets all EMC directive requirements, as per the EMC product standard EN 61800-3.

#### **8.3.1 General Provisions**

As of July 2007, all electrical equipment which has an intrinsic, independent function and which is sold as an individual unit for end users, must comply with Directive 2004/108/EEC (formerly Directive EEC/89/336). There are three different ways for manufacturers to indicate compliance with this directive:

*1. EU Declaration of Conformity*

This is a declaration from the manufacturer, stating that the requirements in the applicable European standards for the electrical environment of the equipment have been met. Only those standards which are published in the Official Journal of the European Community may be cited in the manufacturer's declaration.

*2. Technical documentation*

Technical documentation can be produced which describes the EMC characteristics of the device. This documentation must be authorised by one of the "Responsible bodies" named by the responsible European government. This makes it possible to use standards which are still in preparation.

*3. EU Type test certificate*

This method only applies to radio transmitter equipment.

The devices only have an intrinsic function when they are connected to other equipment (e.g. to a motor). The base units cannot therefore carry the CE mark that would confirm compliance with the EMC directive. Precise details are therefore given below about the EMC behaviour of this product, based on the proviso that it is installed according to the guidelines and instructions described in this documentation.

The manufacturer can certify that his equipment meets the requirements of the EMC directive in the relevant environment with regard to their EMC behaviour in power drives. The relevant limit values correspond to the basic standards EN 61000-6-2 and EN 61000-6-4 for interference immunity and interference emissions.

### 8.3.2 EMC evaluation

Two standards must be observed when evaluating electromagnetic compatibility.

#### 1. EN 55011-1 (environmental standard)

The limits are defined in dependence on the basic environment in which the product is operated in this standard. A distinction is made between 2 environments, whereby the **1st environment** describes the non-industrial **living and business area** without its own high-voltage or medium-voltage distribution transformers. The **2nd environment**, on the other hand, defines **industrial areas** which are not connected to the public low-voltage network, but have their own high-voltage or medium-voltage distribution transformers. The limits are subdivided into **classes A1, A2 and B**.

#### 2. EN 61800-3 (product standard)

The limits are defined in dependence on the usage area of the product in this standard. The limits are subdivided into **categories C1, C2, C3 and C4**, whereby class C4 basically only applies to drive systems with higher voltage ( $\geq 1000$  V AC), or higher currents ( $\geq 400$  A). However, class C4 can also apply to the individual device if it is incorporated in complex systems.

The same limits apply to both standards: However, the standards differ with regard to an application that is extended in the product standard. The user decides which of the two standards applies, whereby the environmental standard applies in the event of a typical fault remedy.

The main connection between the two standards is explained as follows:

Category as per EN 61800-3	C1	C2	C3
Limit class in accordance with EN 55011	B	A1	A2
Operation permissible in			
1. Environment (living environment)	X	X <sup>1)</sup>	-
2. Environment (industrial environment)	X	X <sup>1)</sup>	X <sup>1)</sup>
Note required in accordance with EN-61800-3	-	2)	3)
Sales channel	Generally available	Limited availability	
EMC situation	No requirements	Installation and start-up by EMC expert	
1) Device used neither as a plug-in device nor in moving equipment 2) "The drive system can cause high-frequency interference in a living environment that may make interference suppression measures necessary". 3) "The drive system is not intended for use in a public low-voltage network that feeds residential areas".			

**Table 13: EMC comparison between EN 61800-3 and EN 55011**

### 8.3.3 EMC of device

#### NOTICE!

##### EMC Interference to the environment

This device produces high frequency interference, which may make additional suppression measures necessary in domestic environments (📖 Section 8.3.3 "EMC of device").

- Use of shielded motor cables is essential in order to comply with the specified radio interference suppression level.

The device is exclusively intended for commercial use. It is therefore not subject to the requirements of the standard EN 61000-3-2 for radiation of harmonics.

The limit value classes are only achieved if

- the wiring is EMC-compliant
- the length of shielded motor cable does not exceed the permissible limits
- the standard pulse frequency (P504) is being used

The shielding of the motor cable must be attached at both sides in the motor terminal box and the inverter housing in the event of wall mounting.

Device type Max. motor cable, shielded	Jumper position (chapter 2.4.2.1)	Conducted emissions 150 kHz - 30 MHz	
		Class C2	Class C1
Device motor-mounted	Jumper set (CY=ON)	+	+
Device wall-mounted	Jumper set (CY=ON)	5 m	-

EMC overview of standards that are used in accordance with EN 61800-3 as checking and measuring procedures:		
<i>Interference emission</i>		
Cable-related emission (interference voltage)	EN 55011	C2
		C1 (mounted on motor)
Radiated emission (interference field strength)	EN 55011	C2
		C1 (mounted on motor)
<i>Interference immunity EN 61000-6-1, EN 61000-6-2</i>		
ESD, discharge of static electricity	EN 61000-4-2	6 kV (CD), 8 kV (AD)
EMF, high frequency electro-magnetic fields	EN 61000-4-3	10 V/m; 80 – 1000 MHz
Burst on control cables	EN 61000-4-4	1 kV
Burst on mains and motor cables	EN 61000-4-4	2 kV
Surge (phase-phase / phase-ground)	EN 61000-4-5	1 kV / 2 kV
Cable-led interference due to high frequency fields	EN 61000-4-6	10 V, 0.15 – 80 MHz
Voltage fluctuations and drops	EN 61000-2-1	+10 %, -15 %; 90 %
Voltage asymmetries and frequency changes	EN 61000-2-4	3 %; 2 %

Table 14: Overview according to product standard EN 61800-3

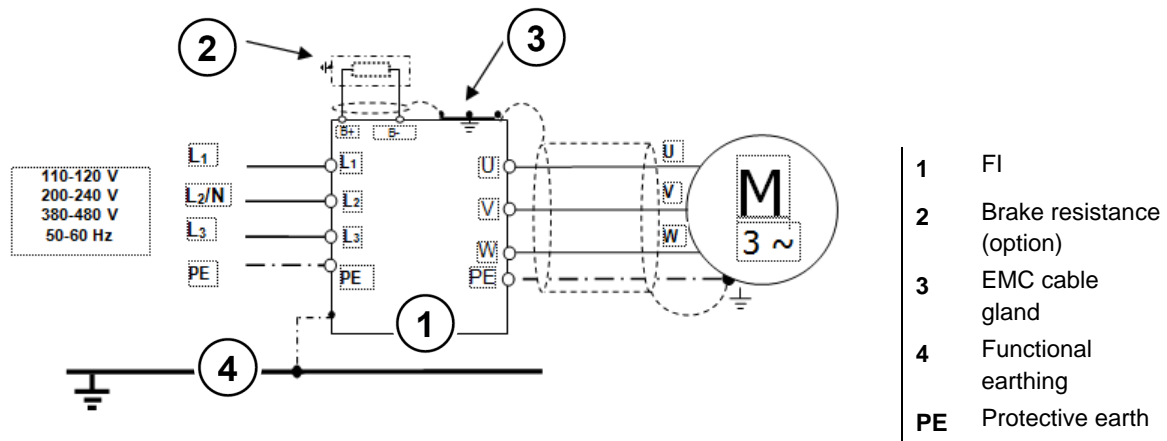

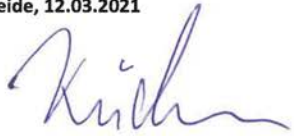



Figure 17: Wiring recommendation

8.3.4 EU Declaration of Conformity

																								
<b>GETRIEBEBAU NORD</b> Member of the NORD DRIVESYSTEMS Group																								
<b>Getriebebau NORD GmbH &amp; Co. KG</b> <small>Getriebebau-Nord-Str. 1. 22941 Bargteheide, Germany. Fon +49(0)4532 289 - 0. Fax +49(0)4532 289 - 2253. info@nord.com</small>																								
<small>C310400_1021</small>																								
<b>EU Declaration of Conformity</b> <small>In the meaning of the EU directives 2014/35/EU Annex IV, 2014/30/EU Annex II, 2009/125/EG Annex IV and 2011/65/EU Annex VI</small>																								
<p>Getriebebau NORD GmbH &amp; Co. KG as manufacturer in sole responsibility hereby declares, <span style="float: right;">Page 1 of 1</span>          that the variable speed drives from the product series NORDAC BASE</p> <ul style="list-style-type: none"> <li>• SK 180E-xxx-123-B-.. , SK 180E-xxx-323-B-.. , SK 180E-xxx-340-B-..</li> <li>• SK 190E-xxx-123-B-.. , SK 190E-xxx-323-B-.. , SK 190E-xxx-340-B-..  <small>(xxx= 250, 370, 550, 750, 111, 151, 221)</small></li> </ul> <p>and the further options/accessories:  <b>SK CU4-... , SK TU4-... , SK TI4-... , SK TIE4-... , SK BRI4-... , SK BRE4-... , SK PAR-3. , SK CSX-3. , SK SSX-3A, SK POT1-.. , SK TIE5-BT-STICK</b></p> <p>comply with the following regulations:</p> <table style="width: 100%; border: none;"> <tr> <td style="width: 30%;"><b>Low Voltage Directive</b></td> <td style="width: 30%;"><b>2014/35/EU</b></td> <td style="width: 40%;">OJ. L 96 of 29.3.2014, p. 357–374</td> </tr> <tr> <td><b>EMC Directive</b></td> <td><b>2014/30/EU</b></td> <td>OJ. L 96 of 29.3.2014, p. 79–106</td> </tr> <tr> <td><b>Ecodesign Directive</b></td> <td><b>2009/125/EG</b></td> <td>OJ. L 285 of 31.10.2009, p. 10–35</td> </tr> <tr> <td><b>Regulation (EU) Ecodesign</b></td> <td><b>2019/1781</b></td> <td>OJ. L 272 of 25.10.2019, p. 74–94</td> </tr> <tr> <td><b>RoHS Directive</b></td> <td><b>2011/65/EU</b></td> <td>OJ. L 174 of 1.7.2011, p. 88–11</td> </tr> <tr> <td><b>Delegated Directive (EU)</b></td> <td><b>2015/863</b></td> <td>OJ. L 137 of 4.6.2015, p. 10–12</td> </tr> </table> <p><b>Applied standards:</b></p> <table style="width: 100%; border: none;"> <tr> <td style="width: 33%;">EN 61800-5-1:2007+A1:2017</td> <td style="width: 33%;">EN 61800-3:2018</td> <td style="width: 33%;">EN 61800-9-1:2017</td> </tr> <tr> <td>EN 60529:1991+A1:2000+A2:2013+AC:2016</td> <td>EN 63000:2018</td> <td>EN 61800-9-2:2017</td> </tr> </table> <p>It is necessary to notice the data in the operating manual to meet the regulations of the EMC-Directive. Specially take care about correct EMC installation and cabling, differences in the field of applications and if necessary original accessories.</p> <p>First marking was carried out in 2014.</p> <p><b>Bargteheide, 12.03.2021</b></p> <div style="display: flex; justify-content: space-around; margin-top: 20px;"> <div style="text-align: center;">  <p>U. Küchenmeister Managing Director</p> </div> <div style="text-align: center;">  <p>pp F. Wiedemann Head of Inverter Division</p> </div> </div>	<b>Low Voltage Directive</b>	<b>2014/35/EU</b>	OJ. L 96 of 29.3.2014, p. 357–374	<b>EMC Directive</b>	<b>2014/30/EU</b>	OJ. L 96 of 29.3.2014, p. 79–106	<b>Ecodesign Directive</b>	<b>2009/125/EG</b>	OJ. L 285 of 31.10.2009, p. 10–35	<b>Regulation (EU) Ecodesign</b>	<b>2019/1781</b>	OJ. L 272 of 25.10.2019, p. 74–94	<b>RoHS Directive</b>	<b>2011/65/EU</b>	OJ. L 174 of 1.7.2011, p. 88–11	<b>Delegated Directive (EU)</b>	<b>2015/863</b>	OJ. L 137 of 4.6.2015, p. 10–12	EN 61800-5-1:2007+A1:2017	EN 61800-3:2018	EN 61800-9-1:2017	EN 60529:1991+A1:2000+A2:2013+AC:2016	EN 63000:2018	EN 61800-9-2:2017
<b>Low Voltage Directive</b>	<b>2014/35/EU</b>	OJ. L 96 of 29.3.2014, p. 357–374																						
<b>EMC Directive</b>	<b>2014/30/EU</b>	OJ. L 96 of 29.3.2014, p. 79–106																						
<b>Ecodesign Directive</b>	<b>2009/125/EG</b>	OJ. L 285 of 31.10.2009, p. 10–35																						
<b>Regulation (EU) Ecodesign</b>	<b>2019/1781</b>	OJ. L 272 of 25.10.2019, p. 74–94																						
<b>RoHS Directive</b>	<b>2011/65/EU</b>	OJ. L 174 of 1.7.2011, p. 88–11																						
<b>Delegated Directive (EU)</b>	<b>2015/863</b>	OJ. L 137 of 4.6.2015, p. 10–12																						
EN 61800-5-1:2007+A1:2017	EN 61800-3:2018	EN 61800-9-1:2017																						
EN 60529:1991+A1:2000+A2:2013+AC:2016	EN 63000:2018	EN 61800-9-2:2017																						

## 8.4 Reduced output power

The frequency inverters are designed for special overload situations. For example, 1.5x overcurrent can be used for 60 s. For approx. 3.5 s, 2x overcurrent is possible. A reduction of the overload capacity or its duration must be considered for the following circumstances:

- Output frequencies < 4.5 Hz and DC voltage (stationary pointer)
- Pulse frequencies greater than the nominal pulse frequency (P504)
- Increased mains voltages > 400 V
- Increased heat sink temperature

The following characteristic curves can be used to obtain the corresponding current/power limit.

### 8.4.1 Increased heat dissipation due to pulse frequency

This illustration shows how the output current must be reduced, depending on the pulse frequency for 230V and 400V devices, in order to avoid excessive heat dissipation in the frequency inverter.

For 400V devices, the reduction begins at a pulse frequency above 6kHz. For 230V devices, the reduction begins at a pulse frequency above 8kHz.

The diagram shows the possible current load capacity for continuous operation.

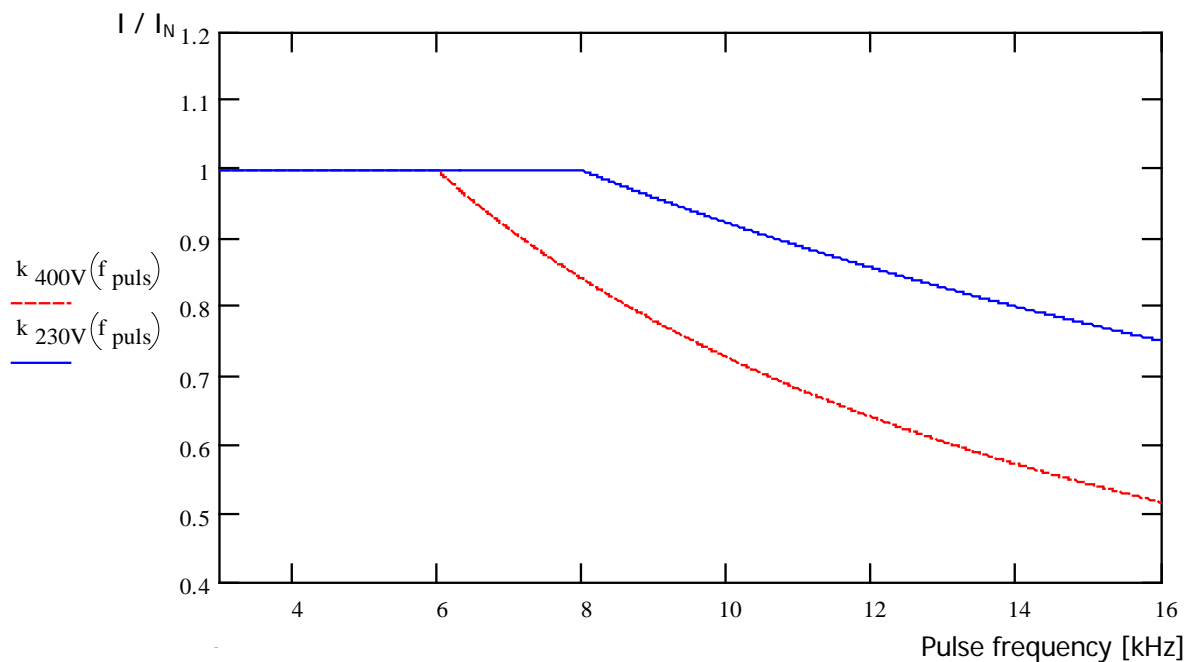

Figure 18: Heat losses due to pulse frequency

**8.4.2 Reduced overcurrent due to time**

The possible overload capacity changes depending on the duration of an overload. Several values are cited in this table. If one of these limiting values is reached, the frequency inverter must have sufficient time (with low utilisation or without load) in order to regenerate itself.

If operated repeatedly in the overload region at short intervals, the limiting values stated in the tables are reduced.

<b>230V devices:</b> Reduced overload capacity (approx.) due to pulse frequency (P504) and time						
Pulse frequency [kHz]	Time [s]					
	> 600	60	30	20	10	3.5
3...8	110%	150%	170%	180%	180%	200%
10	103%	140%	155%	165%	165%	180%
12	96%	130%	145%	155%	155%	160%
14	90%	120%	135%	145%	145%	150%
16	82%	110%	125%	135%	135%	140%

<b>400V devices:</b> Reduced overload capacity (approx.) due to pulse frequency (P504) and time						
Pulse frequency [kHz]	Time [s]					
	> 600	60	30	20	10	3.5
3...6	110%	150%	170%	180%	180%	200%
8	100%	135%	150%	160%	160%	165%
10	90%	120%	135%	145%	145%	150%
12	78%	105%	120%	125%	125%	130%
14	67%	92%	104%	110%	110%	115%
16	57%	77%	87%	92%	92%	100%

Table 15: Overcurrent relative to time

### 8.4.3 Reduced overcurrent due to output frequency

To protect the power unit at low output frequencies (<4.5 Hz) a monitoring system is provided, with which the temperature of the IGBTs (*insulated-gate bipolar transistor*) due to high current is determined. In order to prevent current being taken off above the limit shown in the diagram, a pulse switch-off (P537) with a variable limit is introduced. At a standstill, with 6 kHz pulse frequency, current above 1.1x the nominal current cannot be taken off.

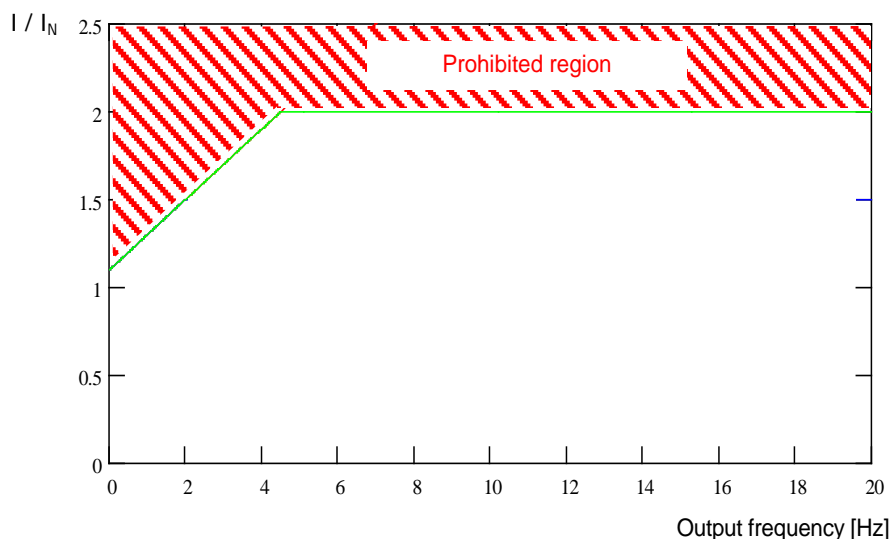

The upper limiting values for the various pulse frequencies can be obtained from the following tables. In all cases, the value (10 ... 201) which can be set in parameter P537, is limited to the value stated in the tables according to the pulse frequency. Values below the limit can be set as required.

230 V devices: Reduced overload capacity (approx.) due to pulse frequency (P504) and output frequency							
Pulse frequency [kHz]	Output frequency [Hz]						
	4.5	3.0	2.0	1.5	1.0	0.5	0
3 ... 8	200 %	170 %	150 %	140 %	130 %	120 %	110 %
10	180 %	153 %	135 %	126 %	117 %	108 %	100 %
12	160 %	136 %	120 %	112 %	104 %	96 %	95 %
14	150 %	127 %	112 %	105 %	97 %	90 %	90 %
16	140 %	119 %	105 %	98 %	91 %	84 %	85 %

400V devices: Reduced overload capacity (approx.) due to pulse frequency (P504) and output frequency							
Pulse frequency [kHz]	Output frequency [Hz]						
	4.5	3.0	2.0	1.5	1.0	0.5	0
3 ... 6	200 %	170 %	150 %	140 %	130 %	120 %	110 %
8	165 %	140 %	123 %	115 %	107 %	99 %	90 %
10	150 %	127 %	112 %	105 %	97 %	90 %	82 %
12	130 %	110 %	97 %	91 %	84 %	78 %	71 %
14	115 %	97 %	86 %	80 %	74 %	69 %	63 %
16	100 %	85 %	75 %	70 %	65 %	60 %	55 %

Table 16: Overcurrent relative to pulse and output frequency



8.4.4 Reduced output current due to low voltage

The frequency inverters are thermally designed with regard to the rated output currents. For lower low voltages larger currents cannot be used in order to keep the output power constant. For mains voltages above 400 V the permissible output current is reduced inversely proportional to the mains voltage in order to compensate for switching losses.

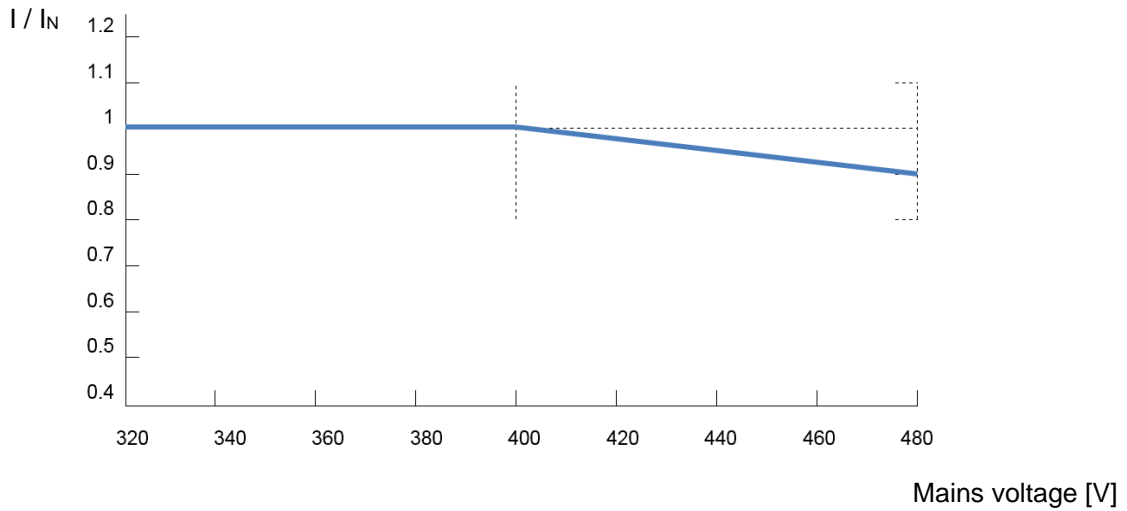

Figure 19: Reduced output current due to low voltage

8.4.5 Reduced output current due to the heat sink temperature

The temperature of the heat sink is included in the calculation of the reduction of output current, so that at low heat sink temperatures, a higher load capacity can be permitted, especially for higher pulse frequencies. At high heat sink temperatures, the reduction is increased correspondingly. The ambient temperature and the ventilation conditions for the device can therefore be optimally exploited.

## 8.5 Operation with FI circuit breakers

With the frequency inverter (except 115V devices), leakage currents of  $\leq 16$  mA are to be expected if the mains filter is active. It is designed for operation on frequency inverters for the protection of persons.

Only all-current sensitive FI circuit breakers (type B or B+) must be used.

(📖 Section 0 "Adaptation to IT networks – (from size 2)")

(📖 See also document [TI 800\\_000000003](#))

### 8.6 System bus

The device and many of the associated components communicate with each other via the system bus. This bus system is a CAN bus with CANopen protocol. Up to four frequency inverters and their components (field bus module, absolute encoder, I/O modules etc.) can be connected to the system bus. Integration of the components into the system bus does not require any specific knowledge of the bus on the part of the user.

Only the proper physical configuration of the bus system and if necessary the correct addressing of the participants need to be taken into account by the user.

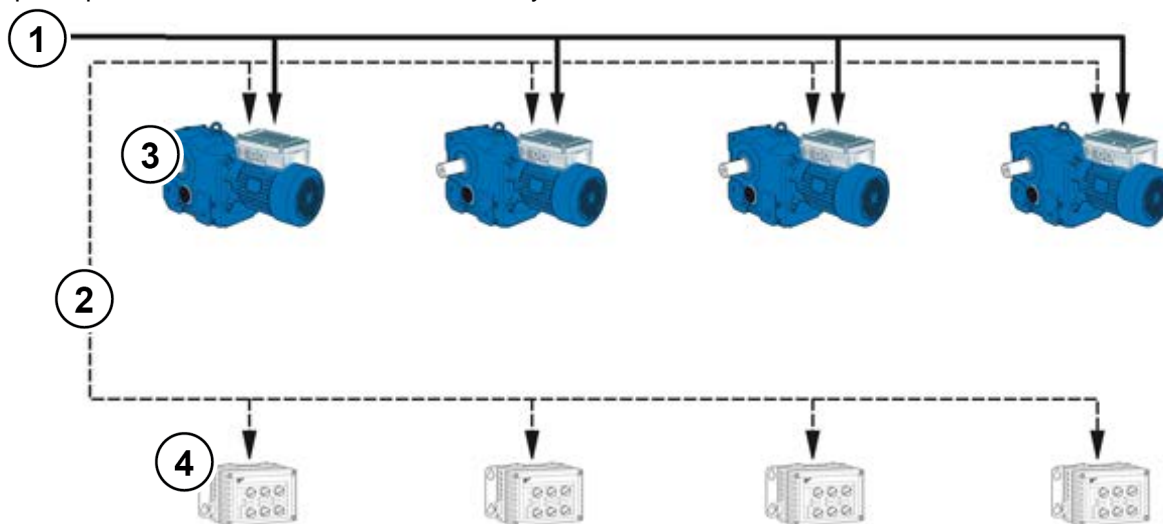

No.	Type
1	Mains connection
2	System bus cable (CAN_H, CAN_L, GND)
3	Frequency inverters
4	Options <ul style="list-style-type: none"> <li>• Bus modules</li> <li>• IO Extensions</li> <li>• CANopen rotary encoder</li> </ul>

Terminal	Meaning
77	System bus+ (CAN_H)
78	System bus- (CAN_L)
40	GND (Reference potential)
Terminal numbers may differ (depending on the device)	

#### Information

#### Communication interference

To minimise the risk of communication interference, the **GND –potentials** (Terminal 40) of all GNDs which are linked via the system bus GND **must be connected together**. The shield of the bus cable must also be connected to PE at both ends.

#### Information

#### Communication on the system bus

Communication on the system bus does not take place until an expansion module is connected to it or if the master in a master/slave system is parameterised to **P503=3** and the slave to **P503=2**. This is particularly important if several frequency inverters connected to the system bus in parallel are to be read out using the NORDCON parameterisation software.

### Physical structure

<b>Standard</b>	CAN
<b>Physical design</b>	2x2, twisted pair, shielded, stranded wires, wire cross-section $\geq 0.25 \text{ mm}^2$ (AWG23), surge impedance approx. $120 \Omega$
<b>Bus length</b>	max. 20 m total expansion (network), max. 20 m between 2 subscribers,
<b>Structure</b>	preferably linear
<b>Spur cables</b>	possible, (max. 6 m)
<b>Termination resistors</b>	120 $\Omega$ , 250 mW at both ends of a system bus (with FI or SK xU4-... via DIP switches)
<b>Baud rate</b>	250 kBaud - preset

The CAN\_H and CAN\_L signals must be connected using a twisted pair of wires. The GND potentials are connected using the second pair of wires.



### Addressing

If several frequency inverters are connected to a system bus, these devices must be assigned with unique addresses. This should preferably take place via the DIP switch S2 at the device (please see chapter 4.3.2.2 "DIP switches (S1, S2)").

For field bus modules, no assignment of addresses is necessary. The module identifies all the frequency inverters automatically. Access to the individual inverters takes place via the field bus master (PLC) Details of how this is carried out are explained in the relevant bus instructions or data sheets for the individual modules.

I/O extensions must be assigned to the relevant frequency inverter. This is carried out by means of a DIP switch on the I/O module. A special case for the I/O extensions is the "Broadcast" mode. In this mode, the data of the I/O extension (analogue values, inputs etc.) are sent to all inverters simultaneously. Via the parameterisation in each individual frequency inverter, a decision is made as to which of the received values are to be used. More information about the settings can be found in the [Data sheets](#) for the relevant modules.



### Information

### Addressing

Care must be taken that each address is only assigned once. In a CAN-based network double assignment of addresses may lead to misinterpretation of the data and therefore undefined activities in the system.

### Integration of devices from other manufacturers

In principle, the integration of other devices into this bus system is possible. These must support the CANopen protocol and a 250 kBaud baud rate. The address range (Node ID) 1 to 4 is reserved for additional CANopen masters. All other participants must be assigned addresses between 50 and 79.

Example of frequency inverter addressing

Frequency inverter	Addressing via DIP switch S2		Resulting Node ID	Frequency inverters
	DIP2	DIP1		
FI 1	OFF	OFF	32	
FI 2	OFF	ON	34	
FI 3	ON	OFF	36	
FI 4	ON	ON	38	

## 8.7 Energy Efficiency

### WARNING

#### Unexpected movement due to overload

In case of overload of the drive there is a risk that the motor will "break down" (sudden loss of torque). An overload may be caused e.g. by inadequate dimensioning of the drive unit or by the occurrence of sudden peak loads. Sudden peak loads may be of a mechanical origin (e.g. blockage) or may be caused by extremely steep acceleration ramps (P102, P103, P426).

Depending on the type of application, "breakdown" of the motor may cause unexpected movement (e.g. dropping of loads by lifting equipment).

To prevent any risk, the following must be observed:

- For lifting equipment applications or applications with frequent large load changes, parameter P219 must remain in the factory setting (100 %).
- Do not inadequately dimension the drive unit, provide adequate overload reserves.
- If necessary, provide fall protection (e.g. for lifting equipment) or equivalent protective measures.

NORD frequency inverters have a low power consumption and are therefore highly efficient. In addition, with the aid of "Automatic flux optimisation" (Parameter (P219)) the inverter provides a possibility for increasing the overall efficiency of the drive in certain applications (in particular applications with partial load).

According to the torque required, the magnetisation current through the frequency inverter or the motor torque is reduced to the level which is required for the momentary drive power. The resulting considerable reduction in power consumption, as well as the optimisation of the  $\cos \varphi$  factor of the motor rating in the partial load range contributes to creating optimum conditions both with regard to energy consumption and mains characteristics.

A parameterisation which is different from the factory setting (Factory setting = 100%) is only permissible for applications which do not require rapid torque changes. (For details, see Parameter (P219))

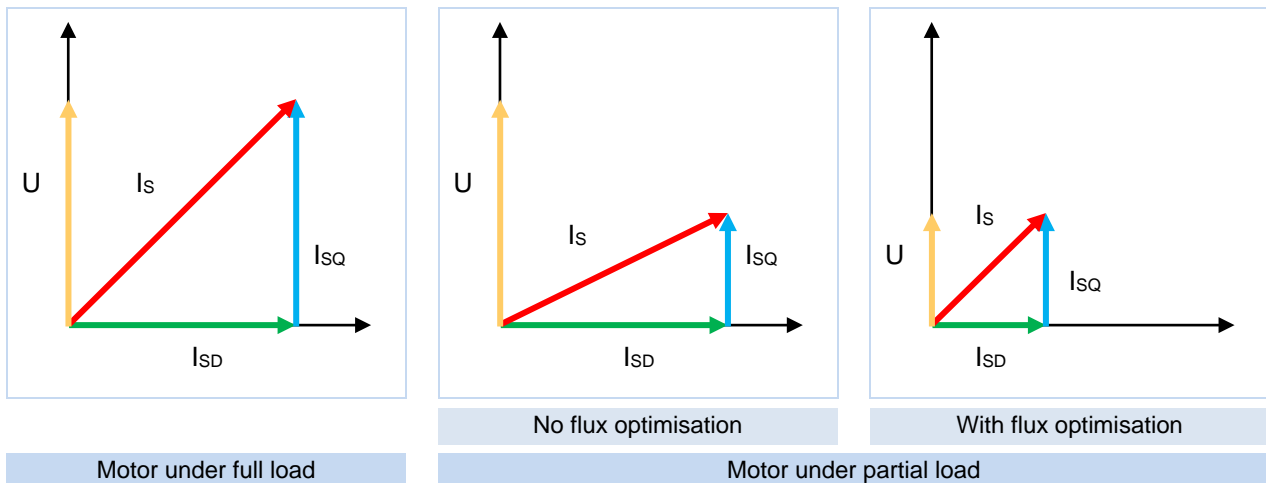

$I_s$  = Motor current vector (line current)  
 $I_{sD}$  = Magnetisation current vector (magnetisation current)  
 $I_{sQ}$  = Load current vector (load current)

Figure 20: Energy efficiency due to automatic flux optimisation

### 8.8 Motor data - characteristic curves

The possible characteristic curves with which the motors can be operated are explained in the following. The rating plate data of the motor is relevant for operation with the 50 Hz or 87 Hz characteristic curve (see Section 4 "Commissioning"). The use of specially calculated motor data is required for operation with a 100 Hz characteristic curve (see Section 8.8.3 "100 Hz characteristic curve (only 400 V devices)").

#### 8.8.1 50 Hz characteristic curve

(→ Variation 1:10)

The motor used for 50 Hz operation can be operated up to its rated point at 50 Hz with nominal torque. Operation above 50 Hz is possible, however the output torque reduces in a non-linear manner (see following diagram). Above the rated point, the motor enters its field weakening range, since the voltage cannot be increased beyond the value of the mains voltage when the frequency is increased above 50 Hz.

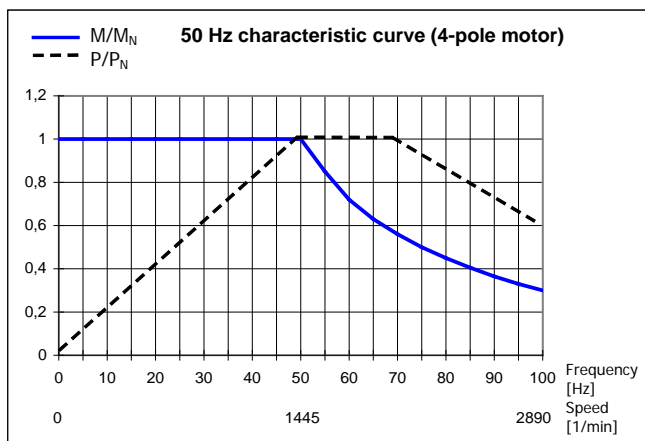

Figure 21: 50 Hz characteristic curve

#### 115 V / 230 V – frequency inverter

With 115 V devices, the input voltage is doubled inside the device so that the required maximum output voltage of 230 V is achieved by the device.

The following data refers to a 230/400V motor winding. They apply for IE1 and IE2 motors. It should be noted that these details may deviate slightly, as motors are subject to certain manufacturing tolerances. It is recommended that the resistance of the connected motor is measured by the frequency inverter (P208 / P220).

Motor (IE1) SK ...	Frequency inverter SK 1xxE-...	M <sub>N</sub> ** [Nm]	Parameterisation data of frequency inverter							
			F <sub>N</sub> [Hz]	n <sub>N</sub> [rpm]	I <sub>N</sub> [A]	U <sub>N</sub> [V]	P <sub>N</sub> [kW]	cos φ	Y/Δ	R <sub>St</sub> [Ω]
71S/4	250-323-A*	1.73	50	1365	1.3	230	0.25	0.79	Δ	39.9
71L/4	370-323-A*	2.56	50	1380	1.89	230	0.37	0.71	Δ	22.85
80S/4	550-323-A*	3.82	50	1385	2.62	230	0.55	0.75	Δ	15.79
80L/4	750-323-A*	5.21	50	1395	3.52	230	0.75	0.75	Δ	10.49
90S/4	111-x23-A	7.53	50	1410	4.78	230	1.1	0.76	Δ	6.41
90L/4	151-323-A	10.3	50	1390	6.11	230	1.5	0.78	Δ	3.99

\* the same data apply for the use of the 115 V version of the SK 1xxE

\*\* at rated point

Motor (IE2) SK ...	Frequency inverter SK 1xxE-...	M <sub>N</sub> ** [Nm]	Parameterisation data of frequency inverter							
			F <sub>N</sub> [Hz]	n <sub>N</sub> [min <sup>-1</sup> ]	I <sub>N</sub> [A]	U <sub>N</sub> [V]	P <sub>N</sub> [kW]	cos φ	Y/Δ	R <sub>St</sub> [Ω]
80SH/4	550-323-A*	3.73	50	1415	2.39	230	0.55	0.7	Δ	9.34
80LH/4	750-323-A*	5.06	50	1410	3.12	230	0.75	0.75	Δ	6.30
90SH/4	111-323-A	7.32	50	1430	4.26	230	1.1	0.8	Δ	4.96
90LH/4	151-323-A	10.1	50	1420	5.85	230	1.5	0.79	Δ	3.27

\* the same data apply for the use of the 115 V version of the SK 1xxE

\*\* at rated point

### b) 400V frequency inverter

The following data is based on an output of 2.2 kW using a 230/400 V motor winding.

They apply for IE1 and IE2 motors. It should be noted that these details may deviate slightly, as motors are subject to certain manufacturing tolerances. It is recommended that the resistance of the connected motor is measured by the frequency inverter (P208 / P220).

Motor (IE1) SK ...	Frequency inverter SK 1xxE-...	M <sub>N</sub> * [Nm]	Parameterisation data of frequency inverter							
			F <sub>N</sub> [Hz]	n <sub>N</sub> [min <sup>-1</sup> ]	I <sub>N</sub> [A]	U <sub>N</sub> [V]	P <sub>N</sub> [kW]	cos φ	Y/Δ	R <sub>St</sub> [Ω]
80S/4	550-340-A	3.82	50	1385	1.51	400	0.55	0.75	Y	15.79
80L/4	750-340-A	5.21	50	1395	2.03	400	0.75	0.75	Y	10.49
90S/4	111-340-A	7.53	50	1410	2.76	400	1.1	0.76	Y	6.41
90L/4	151-340-A	10.3	50	1390	3.53	400	1.5	0.78	Y	3.99
100L/4	221-340-A	14.6	50	1415	5.0	400	2.2	0.78	Y	2.78

\* at rated point

Motor (IE2) SK ...	Frequency inverter SK 1xxE-...	M <sub>N</sub> * [Nm]	Parameterisation data of frequency inverter							
			F <sub>N</sub> [Hz]	n <sub>N</sub> [min <sup>-1</sup> ]	I <sub>N</sub> [A]	U <sub>N</sub> [V]	P <sub>N</sub> [kW]	cos φ	Y/Δ	R <sub>St</sub> [Ω]
80SH/4	550-340-A	3.82	50	1415	1.38	400	0.55	0.7	Y	9.34
80LH/4	750-340-A	5.21	50	1410	1.8	400	0.75	0.75	Y	6.30
90SH/4	111-340-A	7.53	50	1430	2.46	400	1.1	0.8	Y	4.96
90LH/4	151-340-A	10.3	50	1420	3.38	400	1.5	0.79	Y	3.27
100LH/4	221-340-A	14.6	50	1445	4.76	400	2.2	0.79	Y	1.73

\* at rated point



### 8.8.2 87 Hz characteristic curve (only 400V devices)

(→ Variation 01:17)

The 87 Hz - characteristic represents an extension of the speed adjustment range with a constant motor nominal torque. The following points must be met for realisation:

- Motor delta connection with a motor winding for 230/400 V
- Frequency inverter with an operating voltage 3~400 V
- Output current of frequency inverter must be greater than the delta current of the motor used (ref. value → frequency inverter power  $\geq \sqrt{3}$  motor power)

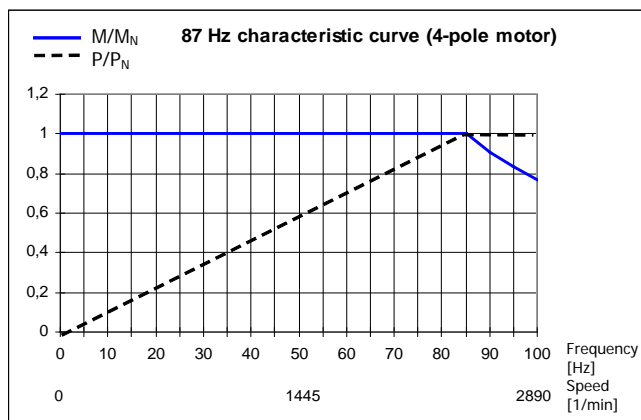

Figure 22: 87 Hz characteristic curve

In this configuration, the motor used has a rated operating point at 230 V/50 Hz and an extended operating point at 400 V/ 87 Hz. This increases the power of the drive by a factor of  $\sqrt{3}$ . The nominal torque of the motor remains constant up to a frequency of 87 Hz. Operation of a 230 V winding with 400 V is totally uncritical as the insulation is designed for test voltages of > 1000 V.

**NOTE: The following motor data applies to standard motors with 230V/400 V windings.**

Motor (IE1) SK ...	Frequency inverter SK 1xxE-....	$M_N^*$ [Nm]	Parameterisation data of frequency inverter							
			$F_N$ [Hz]	$n_N$ [min <sup>-1</sup> ]	$I_N$ [A]	$U_N$ [V]	$P_N$ [kW]	$\cos \varphi$	Y/ $\Delta$	$R_{St}$ [ $\Omega$ ]
71S/4	550-340-A	1.73	50	1365	1.3	230	0.25	0.79	$\Delta$	39.9
71L/4	750-340-A	2.56	50	1380	1.89	230	0.37	0.71	$\Delta$	22.85
80S/4	111-340-A	3.82	50	1385	2.62	230	0.55	0.75	$\Delta$	15.79
80L/4	151-340-A	5.21	50	1395	3.52	230	0.75	0.75	$\Delta$	10.49
90S/4	221-340-A	7.53	50	1410	4.78	230	1.1	0.76	$\Delta$	6.41

\* at rated point

Motor (IE2) SK ...	Frequency inverter SK 1xxE-....	$M_N^*$ [Nm]	Parameterisation data of frequency inverter							
			$F_N$ [Hz]	$n_N$ [min <sup>-1</sup> ]	$I_N$ [A]	$U_N$ [V]	$P_N$ [kW]	$\cos \varphi$	Y/ $\Delta$	$R_{St}$ [ $\Omega$ ]
80SH/4	111-340-A	3.73	50	1415	2.39	230	0.55	0.7	$\Delta$	9.34
80LH/4	151-340-A	5.06	50	1410	3.12	230	0.75	0.75	$\Delta$	6.30
90SH/4	221-340-A	7.32	50	1430	4.26	230	1.1	0.8	$\Delta$	4.96

\* at rated point

### 8.8.3 100 Hz characteristic curve (only 400 V devices)

(→ Variation 01:20)

An operating point 100 Hz/400 V can be selected for a greater speed adjustment range with up to a ratio of 1:20. Special motor data is required in this case (see below) that differs from the normal 50 Hz data. It must be ensured in this case that a constant torque is generated across the entire adjustment range but that it is smaller than the nominal torque for 50 Hz operation.

The advantage, in addition to the greater speed adjustment range, is the improved motor temperature behaviour. An external fan is not absolutely essential for smaller output speed ranges.

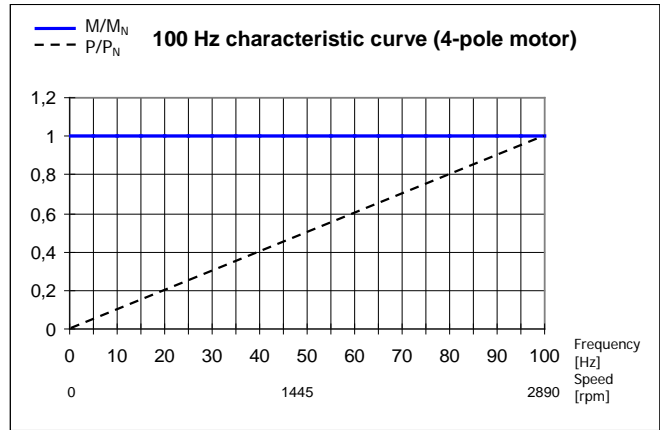

Figure 23: 100 Hz characteristic curve

**NOTE:** The following motor data applies for standard motors with a 230 / 400 V winding. It must be noted that this information may change slightly because the motors are subject to certain tolerances. It is recommended that the resistance of the connected motor is measured by the frequency inverter (P208 / P220).

Motor (IE1) SK ...	Frequency inverter SK 1x0E-...	M <sub>N</sub> * [Nm]	Parameterisation data of frequency inverter							
			F <sub>N</sub> [Hz]	n <sub>N</sub> [min-1]	I <sub>N</sub> [A]	U <sub>N</sub> [V]	P <sub>N</sub> [kW]	cos φ	Y/Δ	R <sub>St</sub> [Ω]
63S/4	250-340-B	0,90	100	2880	0,95	400	0,25	0,63	Δ	47.37
63L/4	370-340-B	1,23	100	2895	1,07	400	0,37	0,71	Δ	39.90
71L/4	550-340-B	1.81	100	2900	1.59	400	0.55	0.72	Δ	22.85
80S/4	750-340-B	2.46	100	2910	2.0	400	0.75	0.72	Δ	15.79
80L/4	111-340-B	3.61	100	2910	2.8	400	1.1	0.74	Δ	10.49
90S/4	151-340-B	4.90	100	2925	3.75	400	1.5	0.76	Δ	6.41
90L/4	221-340-B	7.19	100	2920	4.96	400	2.2	0.82	Δ	3.99

\* at rated point

Motor (IE2) SK ...	Frequency inverter SK 1x0E-...	M <sub>N</sub> * [Nm]	Parameterisation data of frequency inverter							
			F <sub>N</sub> [Hz]	n <sub>N</sub> [min-1]	I <sub>N</sub> [A]	U <sub>N</sub> [V]	P <sub>N</sub> [kW]	cos φ	Y/Δ	R <sub>St</sub> [Ω]
80SH/4	750-340-B	2.44	100	2930	1.9	400	0.75	0.7	Δ	9.34
80LH/4	111-340-B	3.60	100	2920	2.56	400	1.1	0.73	Δ	6.3
90SH/4	151-340-B	4.89	100	2930	3.53	400	1.5	0.79	Δ	4.96
90LH/4	221-340-B	7.18	100	2925	4.98	400	2.2	0.79	Δ	3.27

\* at rated point

Motor (IE3) SK ...	Frequency inverter SK 1xxE-...	M <sub>N</sub> * [Nm]	Parameterisation data of frequency inverter							
			F <sub>N</sub> [Hz]	n <sub>N</sub> [min-1]	I <sub>N</sub> [A]	U <sub>N</sub> [V]	P <sub>N</sub> [kW]	cos φ	Y/Δ	R <sub>St</sub> [Ω]
80SP/4	750-340-A	2.44	100	2935	1.77	400	0.75	0.73	Δ	10.4

Motor (IE3) SK ...	Frequency inverter SK 1xxE-...	$M_N$ * [Nm]	Parameterisation data of frequency inverter							
			$F_N$ [Hz]	$n_N$ [min-1]	$I_N$ [A]	$U_N$ [V]	$P_N$ [kW]	cos $\varphi$	Y/ $\Delta$	$R_{St}$ [ $\Omega$ ]
80LP/4	111-340-B	3.58	100	2930	2.13	400	1.1	0.84	$\Delta$	6.5
90SP/4	151-340-B	4.86	100	2945	3.1	400	1.5	0.79	$\Delta$	4.16
90LP/4	221-340-B	7.17	100	2930	4.33	400	2.2	0.83	$\Delta$	3.15

\* at rated point

## 8.9 Standardisation of setpoint / target values

The following table contains details for the standardisation of typical setpoint and actual values. These details relate to parameters (P400), (P418), (P543), (P546), (P740) or (P741).

Name	Analogue signal		Bus signal					
	Value range	Standardisation	Value range	Max. value	100% =	-100% =	Standardisation	Limitation absolute
Setpoint frequency {01}	0-10V (10V=100%)	P104 ... P105 (min - max) P104+(P105-P104) *U <sub>AIN</sub> (V)/10V	±100%	16384	4000 <sub>hex</sub> 16384 <sub>dec</sub>	C000 <sub>hex</sub> 16384 <sub>dec</sub>	4000 <sub>hex</sub> * f <sub>targ</sub> [Hz]/P105	P105
Frequency addition {02}	0-10V (10V=100%)	P410 ... P411 (min - max) P410+(P411-P410) *U <sub>AIN</sub> [V]/10V	±200%	32767	4000 <sub>hex</sub> 16384 <sub>dec</sub>	C000 <sub>hex</sub> 16384 <sub>dec</sub>	4000 <sub>hex</sub> * f <sub>targ</sub> [Hz]/P411	P105
Frequency subtraction {03}	0-10V (10V=100%)	P410 ... P411 (min - max) P410+(P411-P410) *U <sub>AIN</sub> [V]/10V	±200%	32767	4000 <sub>hex</sub> 16384 <sub>dec</sub>	C000 <sub>hex</sub> 16384 <sub>dec</sub>	4000 <sub>hex</sub> * f <sub>targ</sub> [Hz]/P411	P105
Minimum frequency {04}	0-10V (10V=100%)	50Hz* U <sub>AIN</sub> (V)/10V	0...200% (50Hz=100%)	32767	4000 <sub>hex</sub> 16384 <sub>dec</sub>	/	4000 <sub>hex</sub> * f <sub>min</sub> [Hz] / 50Hz	P105
Maximum frequency {05}	0-10V (10V=100%)	100Hz* U <sub>AIN</sub> (V)/10V	0...200% (100Hz=100%)	32767	4000 <sub>hex</sub> 16384 <sub>dec</sub>	/	4000 <sub>hex</sub> * f <sub>max</sub> [Hz] / 100Hz	P105
Actual value Process controller {06}	0-10V (10V=100%)	P105* U <sub>AIN</sub> (V)/10V	±200%	32767	4000 <sub>hex</sub> 16384 <sub>dec</sub>	C000 <sub>hex</sub> 16384 <sub>dec</sub>	4000 <sub>hex</sub> * f <sub>targ</sub> [Hz]/P105	P105
Setpoint process controller {07}	0-10V (10V=100%)	P105* U <sub>AIN</sub> (V)/10V	±200%	32767	4000 <sub>hex</sub> 16384 <sub>dec</sub>	C000 <sub>hex</sub> 16384 <sub>dec</sub>	4000 <sub>hex</sub> * f <sub>targ</sub> [Hz]/P105	P105
Torque current limit {11}, {12}	0-10V (10V=100%)	P112* U <sub>AIN</sub> (V)/10V	0...100%	16384	4000 <sub>hex</sub> 16384 <sub>dec</sub>	/	4000 <sub>hex</sub> * Torque [%] / P112	P112
Current limit {13}, {14}	0-10V (10V=100%)	P536* U <sub>AIN</sub> (V)/10V	0...100%	16384	4000 <sub>hex</sub> 16384 <sub>dec</sub>	/	4000 <sub>hex</sub> * Current limit [%] / (P536 * 100)	P536
Ramp time {15}	0-10V (10V=100%)	10s* U <sub>AIN</sub> (V)/10V	0...200%	32767	4000 <sub>hex</sub> 16384 <sub>dec</sub>	/	4000 <sub>hex</sub> * Bus setpoint/ 10s	20s
<b>Actual values {Function}</b>								
Actual frequency {01}	0-10V (10V=100%)	P201* U <sub>AOut</sub> (V)/10V	±100%	16384	4000 <sub>hex</sub> 16384 <sub>dec</sub>	C000 <sub>hex</sub> 16384 <sub>dec</sub>	4000 <sub>hex</sub> * f[Hz]/P105	
Speed {02}	0-10V (10V=100%)	P202* U <sub>AOut</sub> (V)/10V	±200%	32767	4000 <sub>hex</sub> 16384 <sub>dec</sub>	C000 <sub>hex</sub> 16384 <sub>dec</sub>	4000 <sub>hex</sub> * n[rpm]/P202	
Current {03}	0-10V (10V=100%)	P203* U <sub>AOut</sub> (V)/10V	±200%	32767	4000 <sub>hex</sub> 16384 <sub>dec</sub>	C000 <sub>hex</sub> 16384 <sub>dec</sub>	4000 <sub>hex</sub> * f[Hz]/P203	
Torque current {04}	0-10V (10V=100%)	P112* 100/ √((P203) <sup>2</sup> - (P209) <sup>2</sup> )* U <sub>AOut</sub> (V)/10V	±200%	32767	4000 <sub>hex</sub> 16384 <sub>dec</sub>	C000 <sub>hex</sub> 16384 <sub>dec</sub>	4000 <sub>hex</sub> * I <sub>q</sub> [A]/(P112)*100/ √((P203) <sup>2</sup> - (P209) <sup>2</sup> )	
Master value Setpoint frequency {19} ... {24}	/	/	±100%	16384	4000 <sub>hex</sub> 16384 <sub>dec</sub>	C000 <sub>hex</sub> 16384 <sub>dec</sub>	4000 <sub>hex</sub> * f[Hz]/P105	

### 8.10 Definition of setpoint and actual value processing (frequencies)

The frequencies used in parameters (P502) and (P543) are processed in various ways according the following table.

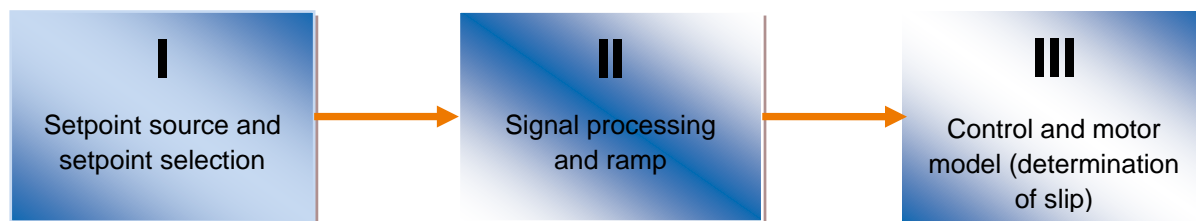

Function	Name	Meaning	Output to ...			without Right/ Left	with Slip
			I	II	III		
8	Setpoint frequency	Setpoint frequency from setpoint source	X				
1	Actual frequency	Setpoint frequency for motor model		X			
23	Actual frequency with slip	Actual frequency at motor			X		X
19	Setpoint frequency master value	Setpoint frequency from setpoint source Master value (free from enable correction)	X			X	
20	Setpoint frequency n R master value	Setpoint frequency for motor model Master value (free from enable correction)		X		X	
24	Master value of actual frequency with slip	Actual frequency at motor Master value (free from enable correction)			X	X	X
21	Actual frequency without slip master value	Actual frequency without master value slip Master value			X		

Table 17: Processing of setpoints and actual values in the frequency inverter

## 9 Maintenance and servicing information

### 9.1 Maintenance Instructions

NORD frequency converters are *maintenance free* provided that they are properly used (please see chapter 7 "Technical data").

#### Dusty environments

If the device is being used in a dusty environment, the cooling-vane surfaces should be regularly cleaned with compressed air.

#### Long-term storage

The device must be regularly connected to the supply network for at least 60 min.

If this is not carried out, there is a danger that the device may be destroyed.

If a device is to be stored for longer than one year, it must be recommissioned with the aid of an adjustable transformer before normal connection to the mains.

#### *Long-term storage for 1 - 3 years*

- 30 min with 25 % mains voltage
- 30 min with 50 % mains voltage
- 30 min with 75 % mains voltage
- 30 min with 100 % mains voltage

#### *Long-term storage for >3 years or if the storage period is not known:*

- 120 min with 25 % mains voltage
- 120 min with 50 % mains voltage
- 120 min with 75 % mains voltage
- 120 min with 100 % mains voltage

The device must not be subject to load during the regeneration process.

After the regeneration process, the regulations described above apply again (at least 60 min on the mains 1x per year).

---

#### Information

#### Accessories

The regulations for **long-term storage** apply to the accessories, such as 24 V power supply modules (SK xU4-24V-..., SK TU4-POT-...), and the electronic brake inverter (SK CU4-MBR) likewise.

---

### 9.2 Service notes

Our Technical Support is available in case of technical queries.

If you contact our technical support, please have the precise device type (type plate/display), accessories and/or options, the software version used (P707) and the series number (type plate) at hand.

The device must be sent to the following address if it needs repairing:

**NORD Electronic DRIVESYSTEMS GmbH**  
 Tjüchkampstraße 37  
 D-26605 Aurich, Germany

Please remove all non-original parts from the device.

No guarantee is given for any attached parts such as power cables, switches or external displays.

Please back up the parameter settings before sending in the device.

#### Information

Please note the reason for sending in the component/device and specify a contact for any queries that we might have.

You can obtain a return note from our web site ([Link](#)) or from our technical support.

Unless otherwise agreed, the device is reset to the factory settings after inspection or repair.

#### Information

In order to rule out the possibility that the cause of a device fault is due to an optional module, the connected optional modules should also be returned in case of a fault.

#### Contacts (Phone)

<b>Technical support</b>	During normal business hours	+49 (0) 4532-289-2125
	Outside normal business hours	+49 (0) 180-500-6184
<b>Repair inquiries</b>	During normal business hours	+49 (0) 4532-289-2115

The manual and additional information can be found on the Internet under [www.nord.com](http://www.nord.com).

### 9.3 Abbreviations

<b>AIN</b>	Analogue input	<b>FI (switch)</b>	Leakage current circuit breaker
<b>AS-i (AS1)</b>	AS Interface	<b>FI</b>	Frequency inverter
<b>ASi (LED)</b>	Status LED – AS interface	<b>I/O</b>	In / Out (Input / Output)
<b>ASM</b>	Asynchronous machine, asynchronous motor	<b>ISD</b>	Field current (Current vector control)
<b>AOUT</b>	Analogue output	<b>LED</b>	Light-emitting diode
<b>AUX</b>	Auxiliary (voltage)	<b>LPS</b>	List of planned slaves (AS-I)
<b>BR</b>	Braking resistor	<b>P1 ...</b>	Potentiometer 1 ...
<b>DI (DIN)</b>	Digital input	<b>PMSM</b>	Permanent magnet synchronous machine / -motor
<b>DigIn</b>		<b>PLC / SPS</b>	Programmable Logical Controller
<b>DS (LED)</b>	Status LED – device status	<b>PELV</b>	Safety low voltage
<b>CFC</b>	Current Flux Control (current-controlled, field-oriented control)	<b>S</b>	Supervisor Parameter, P003
<b>DO (DOUT)</b>	Digital output	<b>S1...</b>	DIP switch 1 ...
<b>DigOut</b>		<b>SW</b>	Software version, P707
<b>I / O</b>	Input /Output	<b>TI</b>	Technical information / Data sheet (Data sheet for NORD accessories)
<b>EEPROM</b>	Non-volatile memory	<b>VFC</b>	Current Flux Control (current-controlled, field-oriented control)
<b>EMKF</b>	Electromotive force (induction voltage)		
<b>EMC</b>	Electromagnetic compatibility		



## Key word index

### 3

3-Wire-Control .....128

### A

Absolute minimum frequency (P505) .....137

Acceleration time (P102) .....98

#### Actual

cos phi (P725).....157

current (P719) .....156

field current (P721) .....156

frequency (P716) .....156

Speed (P717).....156

torque current (P720).....156

voltage (P722).....156

#### Actual

Mains current (P760) .....162

Actual bus value 1 ... 3 (P543) .....148

Actual frequency processing .....205

Actual values .....204

Additional parameters.....136

Address.....207

Adjustment 0% (P402).....121

Adjustment 100% (P403).....122

#### Adjustment range

1/10 .....199, 201, 202

1/17 .....201

Analog input mode (P401).....119

Analog input voltage (P709) .....155

Analogue input filter (P404) .....123

Analogue output voltage (P710).....155

Apparent power (P726) .....157

Array parameters.....95

AS-Interface.....83

#### Assembly

SK 1x0E .....32

ATEX .....21, 24, 36, 54

Optional ATEX modules.....55

#### ATEX

ATEX Zone 22, Cat. 3D .....54

#### ATEX

EU conformity declaration ..... 59

#### ATEX

ATEX Zone 22, Cat. 3D ..... 60

Automatic error acknowledgement P506.... 138

Automatic flux optimisation ..... 198

Automatic flux optimisation (P219) ..... 109

Automatic starting (P428) ..... 130

### B

Basic parameter..... 97

Boost precontrol (P215)..... 108

Brake chopper..... 42

Brake control..... 100, 103

Brake reaction time (P107) ..... 100

Brake release time (P114) ..... 103

Brake resistor (P556)..... 151

Brake resistor type (P557) ..... 151

Braking distance ..... 101

Braking resistor ..... 42, 178

#### Bus

Setpoint (P546) ..... 149

Bus I/O In Bits ..... 134

Bus I/O Out Bits ..... 134

Bus setpoints ..... 149, 150

Bus status via PLC (P353)..... 115

### C

CAN address (P515)..... 139

CAN bus baud rate (P514) ..... 139

CAN master cycle (P552) ..... 150

CANopen status (P748)..... 161

CE mark ..... 185

Configuration level (P744) ..... 160

#### conformity declaration

ATEX ..... 59

Contact..... 207

Control connection ..... 50

Control options..... 14, 16, 63, 90, 164

Control terminals..... 51, 117

Control unit connection.....	50	Electrical data .....	176
Copy parameter set (P101) .....	97	1/3~230 V.....	178
CSA .....	176	Electrical data	
cUL .....	176	1~ 115 V.....	177
Current		Electrical data	
DC brake (P109).....	102	3~ 400 V.....	180
phase U (P732).....	157	EMC Directive .....	46, 185
phase V (P733).....	158	Emerg. stop on error (P427).....	129
phase W (P734).....	158	EMF voltage PMSM (P240).....	110
Current limit (P536) .....	145	Emission of interference .....	188
Current vector control.....	109	EN 55011 .....	186
Curve setting .....	106, 107, 109	EN 61000.....	188
Customer unit .....	66	EN 61800-3.....	186
<b>D</b>		Enable period (P715).....	155
Database version (P742).....	160	Energy Efficiency .....	198
DC Brake .....	101	Environmental standard.....	186
DC braking time On (P110).....	102	Error messages.....	163, 164
DC link voltage (P736).....	158	EU conformity declaration	
DC run-on time (P559) .....	152	ATEX.....	59
Deceleration time (P103).....	98	EU Declaration of Conformity .....	185
delay on/off switch (P475).....	133	<b>F</b>	
Derating .....	32	Factor I <sup>2</sup> t-Motor .....	144
Digital functions .....	126	Factory setting (P523).....	141
Digital inputs (P420) .....	126	Factory settings.....	73
Digital output		FAQ	
function (P434).....	130	Operational problems.....	172
Hysteresis (P436) .....	132	Faults .....	163, 164
Scaling (P435) .....	131	Features.....	11
Dimensions.....	34	FI circuit breaker .....	194
DIP switches.....	78	Field (P730) .....	157
Direct current braking .....	101	Field current controller I (P316) .....	113
Disconnection mode (P108).....	101	Field current controller P (P315).....	113
Display.....	63	Field weakening controller I (P319) .....	114
Display factor (P002).....	97	Field weakening controller P (P318).....	114
Display selection (P001).....	96	Field weakening limit (P320).....	114
Distance calculator .....	101	Filter	
Dynamic boost (P211).....	107	Analog output 1 (P418) .....	125
Dynamic braking.....	42	Fixed frequencies mode (P464).....	132
<b>E</b>		Fixed frequency array (P465) .....	133
EAC Ex .....	21, 24, 36, 54, 60	Flux delay (P558).....	151
Certificate.....	61	Flying start (P520).....	141

Flying start offset (P522) .....	141	Link circuit last error (P705).....	153
Flying start resolution (P521).....	141	Load drop.....	100
Function		Load factory setting.....	141
Bus I/O In Bits (P480) .....	134	Load monitoring .....	135, 143
Bus I/O Out Bits (P481) .....	134	Load monitoring .....	135
Setpoint inputs (P400) .....	117	Load monitoring	
Fuse protection.....	177	Maximum (P525).....	142
<b>G</b>		Load monitoring	
Gateway.....	65	Minimum (P526).....	142
<b>H</b>		Load monitoring	
Heatsink temperature (P739) .....	158	frequency (P527).....	142
Hysteresis of bus I/O Out bits (P483).....	136	Load monitoring	
<b>I</b>		delay (P528) .....	142
I <sup>2</sup> t motor (P535) .....	145	Load monitoring mode (P529) .....	143
Immunity from interference.....	188	<b>M</b>	
Inductivity PMSM (P241) .....	111	M12	
Information.....	152	Connector.....	70
Input voltage (P728) .....	157	Flanged connector .....	70
Installation altitude.....	174	Maintenance .....	206
Internet.....	207	Master - Slave.....	136
Inverter name (P501).....	136	Master function .....	136
Inverter type (P743).....	160	Master function output (P503) .....	137
Inverter voltage range (P747).....	160	Master function value (P502).....	136
IP protection class .....	30	Maximum frequency (P105).....	99
ISD control.....	109	Maximum frequency auxiliary setpoint (P411)	
<b>J</b>		.....	123
Jog frequency (P113) .....	102	Mechanical power (P727) .....	157
<b>K</b>		Menu group.....	90
KTY84-130 .....	80	Messages.....	163, 164
<b>L</b>		Min.freq. process cont. (P466).....	133
Last current error (P703) .....	153	Minimum frequency (P104).....	98
Last fault (P701) .....	153	Minimum frequency auxiliary setpoint (P410)	
Last frequency error (P702).....	153	.....	123
Leakage current.....	194	Modulation depth (P218) .....	108
LEDs .....	163, 164	Module status(P746).....	160
Lifting equipment with brake.....	100	Monitoring	
Limit		Motor temperature.....	80
Field current controller (P317) .....	113	Motor	
Torque current controller (P314).....	113	Cos phi (P206) .....	105
Linear V/f characteristic curve .....	109	Nominal current (P203) .....	105
		Nominal frequency (P201) .....	105

Nominal power (P205) .....	105	Parametrisation options .....	14, 16, 63, 90, 164
Nominal speed (P202) .....	105	Peak current PMSM (P244) .....	111
Nominal voltage (P204) .....	105	PI control I-component (P414) .....	123
Star Delta con. (P207) .....	106	PI control P-component (P413) .....	123
Motor Assembly .....	34	PI- process controller .....	183
Motor data .....	73, 104, 199, 201, 202	PLC display value (P360) .....	116
Motor list (P200) .....	104	PLC functionality (P350) .....	115
Motor temperature monitoring .....	80	PLC Integer setpoint (P355) .....	116
Mounting of optional module .....	40	PLC Long setpoint (P356) .....	116
<b>N</b>		PLC setpoint (P553) .....	150
Name plate .....	27	PLC setpoint selection (P351) .....	115
No-load current (P209) .....	106	PLC Status (P370) .....	116
Nom. val. process ctrl. (P412) .....	123	Plug connectors for control connection .....	70
<b>O</b>		Plug connectors for power connections .....	69
Offset analogue output 1 (P417) .....	124	Plug connectors: .....	69
Op.-time last error (P799) .....	162	PotentiometerBox function (P549) .....	149
Operating display (P000) .....	96	Power limit .....	190
Operating displays .....	96	Power rating / Motor size .....	29
Operating mode .....	177	Present	
Operating status .....	163, 164	fault (P700) .....	152
Operating time .....	155	operating status (P700) .....	152
Operating time (P714) .....	155	Setpoint frequency (P718) .....	156
Operation .....	63	warning (P700) .....	152
Option (mounting) locations .....	38	Process controller .....	117, 133, 183
Option monitoring (P120) .....	103	Process controller control limit (P415) .....	123
Oscillation damping (P217) .....	108	Process data Bus In (P740) .....	159
Oscillation damping PMSM (P245) .....	111	Process data Bus Out (P741) .....	159
Outdoor installation .....	62	Product standard .....	186
Output monitoring (P539) .....	146	PT100 .....	80
Overvoltage .....	166	PT1000 .....	80
Overvoltage switch-off .....	42	Pulse disconnection .....	144, 146
<b>P</b>		Pulse disconnection (P537) .....	146
P chopper limit (P555) .....	151	Pulse frequency (P504) .....	137
P factor torque limit (P111) .....	102	<b>Q</b>	
P set last error (P706) .....	154	Quick stop time (P426) .....	129
Parameter identification .....	110	<b>R</b>	
Parameter identification (P220) .....	110	Ramp smoothing (P106) .....	99
Parameter set (P100) .....	97	Ramp time PI setpoint (P416) .....	124
Parameter set (P731) .....	157	Rating point	
Parameter, saving mode (P560) .....	152	50Hz .....	199, 201, 202
		87Hz .....	201

Reason FI disabled (P700).....	152	Static boost (P210) .....	106
reduced output power.....	190	Statistic	
Relays		Mains failure (P752) .....	161
Set (P541).....	147	Overcurrent (P750) .....	161
Reluctance angle IPMSM (P243) .....	111	Overvoltage (P751) .....	161
Repairs .....	207	Statistics	
Retrofitting the device.....	33	Customer error (P757) .....	162
Rotation direction.....	147	Overheating (P753).....	161
Rotation direction mode (P540).....	147	Parameter loss (P754) .....	162
Rotor starting position detection (P330) .....	114	System faults (P755).....	162
<b>S</b>		Time out (P756).....	162
Scaling		Stator resistance (P208) .....	106
Bus I/O In Bits (P482) .....	135	Status	
Service.....	207	Digital input (P708).....	154
Servo mode (P300) .....	112	DIP switches (P749).....	161
Set analogue output (P542).....	148	Storage .....	206
Set digital output (P541) .....	147	Supervisor code (P003) .....	97
Setpoint frequency processing .....	205	Support .....	207
Setpoint processing .....	156, 182	Switch-on cycles .....	174
Setpoint source (P510).....	138	Switchover freq.VFC PMSM (P247) .....	111
Setpoints.....	204	System bus .....	138, 139, 195
SK BRE4- .....	43, 44	System bus tunnelling.....	65
SK BREW4- .....	43, 44	<b>T</b>	
SK BRI4-.....	42, 44	Technical data.....	32, 47, 48, 174, 206
SK BRW4- .....	43	Technical Data	
SK CU4-POT .....	72	Frequency inverter .....	174
SK TIE4-WMK- .....	36	Technology unit.....	67
Skip frequency 1 (P516).....	140	Telegram timeout (P513) .....	139
Skip frequency 2 (P518).....	140	Temperature sensor.....	80
Skip frequency area 1 (P517).....	140	Three-phase standard motor .....	104
Skip frequency area 2 (P519).....	140	Time boost precontrol (P216) .....	108
Slip compensation (P212) .....	107	Torque (P729).....	157
Software version (P707) .....	154	Torque current controller I (P313).....	113
Source control word (P509).....	138	Torque current controller P (P312) .....	113
Speed control .....	112	Torque current limit (P112) .....	102
Speed controller I (P311).....	112	Torque disconn. limit (P534).....	144
Speed controller P (P310) .....	112	Torque precontrol (P214).....	107
Standardisation		Total currents .....	50
Analogue output 1 (P419).....	126	Type code .....	27
Setpoint / actual values.....	204	Type plate .....	73
State of relays (P711).....	155		

<b>U</b>	Voltage last error (P704).....	153
UL/CSA approval.....	Voltage –q (P724) .....	156
Usage rate brakeres. (P737) .....	<b>W</b>	
Usage rate Motor (P738) .....	Wall-mounting .....	36
USS address (P512).....	Warning messages .....	152, 169
USS baud rate (P511) .....	Warnings .....	152, 163, 164, 169
<b>V</b>	Watchdog.....	132
Var. ISD control (P213) .....	Watchdog time (P460) .....	132
Vector control .....	Weight.....	34
Ventilation .....	Wiring guidelines.....	46
Voltage –d (P723).....		



**NORD DRIVESYSTEMS Group**

**Headquarters and Technology Centre**  
in Bargteheide, close to Hamburg

**Innovative drive solutions**  
for more than 100 branches of industry

**Mechanical products**  
parallel shaft, helical gear, bevel gear and worm gear units

**Electrical products**  
IE2/IE3/IE4 motors

**Electronic products**  
centralised and decentralised frequency inverters,  
motor starters and field distribution systems

**7 state-of-the-art production plants**  
for all drive components

**Subsidiaries and sales partners**  
**in 98 countries on 5 continents**  
provide local stocks, assembly, production,  
technical support and customer service

**More than 4,000 employees throughout the world**  
create customer oriented solutions

[www.nord.com/locator](http://www.nord.com/locator)

**Headquarters:**

**Getriebebau NORD GmbH & Co. KG**

Getriebebau-Nord-Straße 1  
22941 Bargteheide, Germany

T: +49 (0) 4532 / 289-0

F: +49 (0) 4532 / 289-22 53

[info@nord.com](mailto:info@nord.com), [www.nord.com](http://www.nord.com)

**Member of the NORD DRIVESYSTEMS Group**

