

Intelligent Drivesystems, Worldwide Services



EN

BU 0500

SK 500E

Users Manual for Frequency Inverters





Safety and usage instructions for electronic drive technology

(drive power controller, motor starter¹⁾ and field distributor)

(in accordance with: Low Voltage Directive 2006/95/EC (as of 20.04.2016: 2014/35/EU))

1. General

The devices may have live, bare, moving or rotating parts or hot surfaces during operation, depending on their protection class.

Unauthorised removal of covers, improper use, incorrect installation or operation causes a risk of serious personal injury or material damage.

Further information can be found in this documentation.

All transportation, installation commissioning and maintenance work must be carried out by qualified personnel (compliant with IEC 364 or CENELEC HD 384 or DIN VDE 0100 and IEC 664 or DIN VDE 0110 and national accident prevention regulations).

For the purposes of these basic safety instructions, qualified personnel are persons who are familiar with the assembly, installation, commissioning and operation of this product and who have the relevant qualifications for their work.

2. Proper use in Europe

The devices are components intended for installation in electrical systems or machines.

When the devices are installed in machines, they must not be started up (i.e. commencement of use for intended purpose) until it has been ensured that the machine meets the provisions of the EC Directive 2006/42/EC (Machinery Directive); EN 60204 must also be complied with.

Starting up (i.e. commencement of use for intended purpose) is only permitted if EMC directive (2004/108/EC (as of 20.04.2016: 2014/30/EU)) has been complied with.

CE-labelled devices fulfil the requirements of the Low Voltage Directive 2006/95/EC (as of 20.04.2016: 2014/35/EU). The stated harmonized standards for the devices are used in the declaration of conformity.

Technical data and information for connection conditions can be found on the rating plate and in the documentation, and must be complied with.

The devices may only be used for safety functions which are described and explicitly approved.

3. Transport, storage

Information regarding transport, storage and correct handling must be complied with.

4. Installation

The installation and cooling of the equipment must be implemented according to the regulations in the corresponding documentation.

The devices must be protected against impermissible loads. Especially during transport and handling, components must not be deformed and/or insulation distances must not be changed. Touching of electronic components and contacts must be avoided.

The devices contain electrostatically sensitive components, which can be easily damaged by incorrect handling. Electrical components must not be mechanically damaged or destroyed (this may cause a health hazard!).

5. Electrical Connection

When working on live devices, the applicable national accident prevention regulations must be complied with (e.g. BGV A3, formerly VBG 4).

The electrical installation must be implemented according to the applicable regulations (e.g. cable cross-section, fuses, earth lead connections). Further instructions can be found in the documentation.

Information regarding EMC-compliant installation (such as shielding, earthing, location of filters and routing of cables) can be found in the documentation for the devices. CE marked devices must also comply with these instructions. Compliance with the limit values specified in the EMC regulations is the responsibility of the manufacturer of the system or machine.

6. Operation

Where necessary, systems in which the devices are installed must be equipped with additional monitoring and protective equipment according to the applicable safety requirements, e.g. legislation concerning technical equipment, accident prevention regulations, etc.

The parametrisation and configuration of the devices must be selected so that no hazards can occur.

All covers must be kept closed during operation.

7. Maintenance and repairs

Live equipment components and power connections should not be touched immediately after disconnecting the devices from the power supply because of possible charged capacitors. Observe the applicable information signs located on the device.

Further information can be found in this documentation.

These safety instructions must be kept in a safe place!

¹⁾ Direct starter, soft starter, reversing starter

Intended use of the frequency inverter

Compliance with the operating instructions is **necessary for fault-free** operation and the acceptance of any warranty claims. **These operating instructions must be read** before working with the device!

These operating instructions contain **important information about servicing**. They must therefore be kept **close to the device**.

SK 500E series frequency inverters are devices for industrial and commercial systems used for the operation of three-phase asynchronous motors with squirrel-cage rotors and **P**ermanent **M**agnet **S**ynchronous **M**otors – PMSM. These motors must be suitable for operation with frequency inverters, other loads must not be connected to the devices.

SK 5xxE frequency inverters are devices for stationary installation in control cabinets. All details regarding technical data and permissible conditions at the installation site must be complied with.

Commissioning (commencement of the intended use) is not permitted until it has been ensured that the machine complies with the EMC Directive 2004/108/EEC (from 04/20/2016: 2014/30/EU) and that the conformity of the end product meets the Machinery Directive 2006/42/EEC (observe EN 60204).

© Getriebebau NORD GmbH & Co. KG, 2016

Documentation

Title:	BU 0500	
Order – No.:	6075002	
Series:	SK 500E	
Device series:	SK 500E, SK 505E, SK 510E, SK 511E, SK 515E, SK 520E, SK 530E, SK 535E	(SK 540E, SK 545E see BU 0505)
Device types:	<i>SK 5xxE-250-112- ... SK 5xxE-750-112-</i>	(0.25 – 0.75kW, 1~ 115V, Out: 3~...230V)
	<i>SK 5xxE-250-323- ... SK 5xxE-221-323-</i>	(0.25 – 2.2kW, 1/3~ 230V, Out: 3~...230V)
	<i>SK 5xxE-301-323- ... SK 5xxE-182-323-</i>	(3.0 – 18.5kW, 3~ 230V, Out: 3~...230V)
	<i>SK 5xxE-550-340- ... SK 5xxE-163-340-</i>	(0.55 – 160.0kW, 3~ 400V, Out: 3~...400V)

Version list

Title, Date	Order number	Device software version	Remarks
BU 0500, March 2005	6075002 / 1005	V 1.1 R1	First issue.
Further revisions: May, June, August, December 2005, May, October 2006, May, August 2007, February, May 2008 (For an overview of the amendments to the above editions: please refer to the April 2009 version (Part No.: 6075002/1409))			
Further revisions: April 2009, November 2010, February, April 2011 (For an overview of the amendments to the above editions: please refer to the April 2011 version (Part No.: 6075002/1411))			
Further revisions: September 2011, March 2013 (For an overview of the amendments to the above editions: please refer to the March 2013 version (Part No.: 6075002/1013))			
Further revisions: February 2015 (For an overview of the amendments to the above editions: please refer to the February 2015 version (Part No.: 6075002/0715))			
BU 0500, April 2016	6075002 / 1516	V 3.1 R0	Including: <ul style="list-style-type: none"> • General corrections • Adaptation of parameters: P220, 241, 312, 315, 334, 504, 513, 520, 740, 741, 748 • Error message I000.8 and I000.9 added • Revision of section "Standards and Approvals" • Revision of section "UL/cUL" <ul style="list-style-type: none"> – for CSA: Voltage limitation filter (SK CIF) no longer required → Module removed from document – Size 10 and 11: Note "in progress" deleted, amendment of fuses • Revision of the "Technical / Electrical Data", size 10 and 11 Amendment of fuses (types and sizes) • Update of EC/EU Declaration of Conformity • Revision of the section "General conditions for ColdPlate technology"
BU 0500, July 2021	6075002 / 3021	V 1.3 R0	<ul style="list-style-type: none"> • Update "Standards and approvals" • Update of EU Declaration of Conformity • Addition of the energy efficiency levels according to the EU Ecodesign Regulation 1781

Table 1: Version list

Copyright notice

As an integral component of the device described here, this document must be provided to all users in a suitable form.

Any editing or amendment or other utilisation of the document is prohibited.

Publisher

Getriebebau NORD GmbH & Co. KG

Getriebebau-Nord-Straße 1 • 22941 Bargteheide, Germany • <http://www.nord.com/>

Fon +49 (0) 45 32 / 289-0 • Fax +49 (0) 45 32 / 289-2253

Table of Contents

1	General	10
1.1	Overview	10
1.2	SK 5xxE with or without integrated mains filter	12
1.2.1	Operation of an SK 5xxE-...-A frequency inverter	12
1.2.2	Operation of an SK 5xxE-...-O frequency inverter.....	12
1.2.3	Which type of inverter should be used?.....	13
1.3	Delivery	13
1.4	Scope of supply	13
1.5	Safety and installation notes	18
1.5.1	Explanation of labels used	19
1.5.2	List of safety and installation notes	19
1.6	Standards and approvals	21
1.7	UL and cUL (CSA) approval	21
1.8	Type code / nomenclature	27
1.8.1	Type plate.....	28
1.8.2	Frequency inverter type code	28
1.8.3	Optional technology units (module type codes)	28
2	Assembly and installation	29
2.1	SK 5xxE, standard version.....	30
2.2	SK 5xxE...-CP in ColdPlate version.....	31
2.3	External heat sink kit	32
2.4	Snap-on mounting rail kit SK DRK1-.....	34
2.5	EMC Kit	35
2.6	Brake resistor (BR).....	36
2.6.1	Electrical data for brake resistors	37
2.6.2	Dimensions of bottom-mounted BR SK BR4.....	38
2.6.3	Dimensions of chassis BR SK BR2.....	40
2.6.4	Brake resistor assignments.....	40
2.6.5	Combination of brake resistors	41
2.6.6	Monitoring of the brake resistor	44
2.6.6.1	Monitoring with a temperature switch	44
2.6.6.2	Monitoring with current measurement and calculation	44
2.7	Chokes.....	45
2.7.1	Mains chokes.....	45
2.7.1.1	Link circuit choke SK DCL-.....	45
2.7.1.2	Input choke SK CI1-.....	46
2.7.2	Output choke SK CO1	47
2.8	Line filter	49
2.8.1	Mains filter SK NHD (up to size 4).....	49
2.8.2	Mains filter SK LF2 (size 5 - 7)	49
2.8.3	Line filter SK HLD	50
2.9	Electrical connection	51
2.9.1	Wiring guidelines.....	52
2.9.2	Adaptation to IT networks.....	53
2.9.3	DC-coupling	55
2.9.4	Electrical connection of power unit.....	58
2.9.5	Electrical connection of the control unit	60
2.10	Colour and contact assignments for encoders	71
2.11	RJ45 WAGO- Connection module.....	73
3	Displays and control	74
3.1	Modular assemblies SK 5xxE	74
3.2	Overview of technology units.....	75
3.3	SimpleBox, SK CSX-0.....	78
3.3.1	PotentiometerBox, SK TU3-POT	81
3.4	Connection of multiple device to a parameterisation tool.....	82
4	Commissioning	83
4.1	Factory settings	83

4.2	Selecting the operating mode for motor control	84
4.2.1	Explanation of the operating modes (P300)	84
4.2.2	Overview of control parameter settings	85
4.2.3	Motor control commissioning steps	86
4.3	Minimal configuration of control connections	87
4.4	KTY84-130 connection (above software version 1.7)	88
4.5	Frequency addition and subtraction via operating boxes	89
5	Parameters	90
6	Operating status messages	159
6.1	Display of messages	159
6.2	Messages	160
7	Technical data	168
7.1	General Data SK 500E	168
7.2	Technical data for determining the energy efficiency level	170
7.3	Electrical data	172
7.3.1	Electrical data 115 V	172
7.3.2	Electrical data 230 V	173
7.3.3	Electrical data 400 V	176
7.4	General conditions for ColdPlate technology	181
8	Additional information	184
8.1	Setpoint processing	184
8.2	Process controller	186
8.2.1	Process controller application example	186
8.2.2	Process controller parameter settings	187
8.3	Electromagnetic compatibility (EMC)	188
8.3.1	General Provisions	188
8.3.2	EMC evaluation	188
8.3.3	EMC of device	189
8.3.4	EC Declaration of Conformity	192
8.4	Reduced output power	193
8.4.1	Increased heat dissipation due to pulse frequency	193
8.4.2	Reduced overcurrent due to time	194
8.4.3	Reduced overcurrent due to output frequency	195
8.4.4	Reduced output current due to mains voltage	196
8.4.5	Reduced output current due to the heat sink temperature	196
8.5	Operation with FI circuit breakers	197
8.6	Energy Efficiency	197
8.7	Standardisation of setpoint / target values	198
8.8	Definition of setpoint and actual value processing (frequencies)	199
9	Maintenance and servicing information	200
9.1	Maintenance Instructions	200
9.2	Service notes	201
9.3	Abbreviations	202

List of illustrations

Fig. 1 Mounting distances for SK 5xxE	29
Fig. 2: EMC Kit SK EMC2-x.....	35
Fig. 3: Bottom-mounted brake resistor SK BR4-.....	36
Fig. 4: chassis brake resistor SK BR2-.....	36
Fig. 5: Illustration of mounting the BR4- on the frequency inverter	38
Fig. 6: Typical brake resistor connections	43
Fig. 7 Diagram of a DC-coupling	56
Fig. 8 Diagram of a DC coupling with an input/feedback unit	57
Fig. 9: Modular assemblies SK 5xxE	74
Fig. 10 SimpleBox SK CSX-0	78
Fig. 11 Top side of FI with RJ12 / RJ45 connection	78
Fig. 12: SimpleBox, SK CSX-0 menu structure	80
Fig. 13 Motor type plate	83
Fig. 14: Setpoint processing	185
Fig. 15: Process controller flow diagram.....	186
Figure 16: Wiring recommendation.....	191
Figure 17: Heat losses due to pulse frequency.....	193
Figure 18: Output current due to mains voltage.....	196
Figure 19: Energy efficiency due to automatic flux optimisation	197

List of tables

Table 1: Version list	4
Table 2: Overview of SK 500E performance grading features.....	11
Table 3: Overview of differing hardware features	11
Table 4: Standards and approvals.....	21
Table 5: EMC Kit SK EMC2-x.....	35
Table 6: Electrical data for brake resistor SK BR2-... and SK BR4-... ..	37
Table 7: Brake resistor temperature switch data	38
Table 8: Dimensions of bottom-mounted brake resistor SK BR4-... ..	38
Table 9: Dimensions of chassis brake resistor SK BR2-... ..	40
Table 10: Combination of standard brake resistors	43
Table 11: Link circuit choke SK DCL-.....	45
Table 12: Input choke data for SK CI1-..., 1~ 240 V	46
Table 13: Input choke data for SK CI1-..., 3~ 240 V	46
Table 14: Input choke data for SK CI1-..., 3~ 480 V	47
Table 15: Output choke data for SK CO1-..., 3~ 240 V	48
Table 16: Output choke data for SK CO1-..., 3~ 480 V	48
Table 17: Mains filter NHD-.....	49
Table 18: Mains filter LF2-.....	49
Table 19: Mains filter HLD-.....	50
Table 20: Adaptation of integrated mains filter	53
Table 21: Tools.....	58
Table 22: Connection data	58
Table 23: Colour and contact assignments for NORD – TTL / HTL incremental encoders.....	72
Table 24: RJ45 WAGO connection module.....	73
Table 25: Overview of Technology Units and Control Boxes.....	75
Table 26: Overview of Technology Units and Bus Systems	76
Table 27: Overview of technology units, other optional modules.....	76
Table 28: SimpleBox SK CSX-0, functions	79
Table 29: Technical data, ColdPlate 115V devices	181
Table 30: Technical data, ColdPlate 230V devices, single phase operation	181
Table 31: Technical data, ColdPlate 230V devices, three phase operation.....	182
Table 32: Technical data, ColdPlate 400V devices	182
Table 33: EMC comparison between EN 61800-3 and EN 55011	189
Table 34: EMC, max. shielded motor cable length with regard to compliance with the limit value classes	190
Table 35: Overview according to product standard EN 61800-3	191
Table 36: Overcurrent relative to time	194
Table 37: Overcurrent relative to pulse and output frequency	195
Table 38: Scaling of setpoints and actual values (Selection).....	198
Table 39: Processing of setpoints and actual values in the frequency inverter	199

1 General

The SK 500E - SK 535E series is based on the tried and tested NORD platform. The devices are characterised by their compact design and optimum control characteristics, and have uniform parametrisation.

The devices have sensor-less current vector control with a wide range of settings. In combination with suitable motor models, which always provide an optimised voltage/frequency ratio, all three-phase asynchronous motors that are suitable for inverter operation and permanently excited synchronous motors can be driven. For the drive unit, this means very high starting and overload torques with constant speed.

The performance range extends from 0.25 kW bis 160.0 kW.

The use of modular modules means that the device series can be adapted to individual customer requirements.

This manual is based on the device software as stated in the version list (see P707). If the frequency inverter uses a different software version, this may cause differences. If necessary, the current manual can be downloaded from the Internet (<http://www.nord.com/>).

Additional descriptions for optional functions and bus systems exist (<http://www.nord.com/>).



Information

Accessories

The accessories mentioned in the manual are also subject to change. Current details of these are summarised in separate data sheets, which are available at www.nord.com under the heading *Documentation* → *Manuals* → *Electronic Drive Technology* → *Techn. Info / Data Sheet*. The data sheets available at the date of publication of this manual are listed by name in the relevant sections (TI ...).

As standard, the frequency inverters are equipped with a fixed heat sink, via which the power losses are dissipated to the environment. Alternatively, for sizes 1 - 4 there is the ColdPlate version and for sizes 1 and 2 there is also an external heat sink version.

As standard, inverters for 230V or 400V operating voltage are supplied with an integrated mains filter. However, versions without a mains filter are available for frequency inverters above Size 7. Frequency inverters for 115V operating voltage are normally supplied without mains filters.

1.1 Overview

Properties of the basic frequency inverter **SK 500E**:

- High starting torque and precise motor speed control setting with sensorless current vector control
- Can be mounted next to each other without additional spacing
- Permissible ambient temperature range 0 to 50°C (please refer to the technical data)
- Frequency inverters Type SK 5xxE ... **-A**: Integrated **EMC mains filter** for limit curve A1 (and B1 for inverters Size 1 - 4) according to EN 55011, Category C2 (and C1 for inverters Size 1 - 4) according to EN 61800-3 (not for 115 V inverters)
- Frequency inverters Type SK 5xxE ... **-O**: **without** integrated **EMC mains filter**.
- Automatic measurement of the stator resistance or determination of the precise motor data
- Programmable direct current braking
- Integrated brake chopper for 4 quadrant operation (optional brake resistors)
- Four separate online switchable parameter sets
- RS232/485 interface via RJ12 plug connector
- Integrated USS and Modbus RTU (see [BU 0050](#))

Feature	SK ...	50xE	51xE	511E	520E	53xE	54xE	Additional options
Operating manual		BU 0500					BU 0505	
Safe pulse block (STO / SS1)*			x	x		x	x	BU 0530
2 x CANbus/CANopen interfaces via RJ45 plug				x	x	x	x	BU 0060
RS485 interface additionally via terminals					x	x	x	
Speed feedback via incremental encoder input					x	x	x	
Integrated "POSICON" positioning control						x	x	BU 0510
CANopen absolute encoder evaluation						x	x	BU 0510
PLC / SPS – functionality					x	x	x	BU 0550
Universal encoder interface (SSI, BISS, Hiperface, EnDat and SIN/COS)							x	BU 0510
Operation of PM synchronous motors (Permanent Magnet Synchronous Motors)	x	x	x	x	x	x	x	
Number of digital inputs / outputs**	5 / 0	5 / 0	5 / 0	7 / 2	7 / 2	5 / 3 / 6 / 2 / 7 / 1		
Additional potential-isolated PTC input***							x	
Number of analog inputs / outputs	2 / 1	2 / 1	2 / 1	2 / 1	2 / 1	2 / 1	2 / 1	
Number of relay messages	2	2	2	2	2	2	2	
* not with 115 V devices ** SK 54xE: 2 I/Os can be variably parameterised as inputs or outputs *** alternative "thermistor" function on digital input 5 possible (above size 5 an additional thermistor input is available as standard)								

Table 2: Overview of SK 500E performance grading features

Differing hardware features

Version	Description
SK 5xxE-...-CP compared with SK 5xxE	<ul style="list-style-type: none"> ColdPlate or external heat sink
SK 5x5E compared with SK 5x0E	<ul style="list-style-type: none"> External 24V supply voltage. Communication with the frequency inverter is possible even without a power connection
For size 5 and above in comparison with sizes 1 – 4 (> 4 kW, 230V or > 11 kW, 400V)	<ul style="list-style-type: none"> Additional, separately mounted PTC input (potential isolated) External 24V supply voltage with automatic switchover to the internal 24V low voltage generator on failure of the external control voltage. Processing of both bipolar and analog signals 2 x CANbus/CANopen interfaces via RJ45 plug as standard

Table 3: Overview of differing hardware features

1.2 SK 5xxE with or without integrated mains filter

NORD supplies the inverter series (SK 500E ... SK 545E) in two different versions, which differ in that in contrast to the type Typ SK 5xxE-...-**A**, the inverter type SK 5xxE-...-**O** is equipped with an **EMC mains filter** at the factory.

The **EMC mains filter** which is integrated into the SK 5xx-...-**A** types is fitted to the mains input and is used to fulfil the requirements of the EMC Directive 2004/108/EC (issue of the CE mark).

1.2.1 Operation of an SK 5xxE-...-A frequency inverter

If an **input choke** is connected upstream of the frequency inverter, a resonance circuit results from the mains impedance, the input choke and the X2-capacitors of the internal EMC filter.

This resonance circuit is excited by harmonics in the mains voltage as well as by switching actions in the mains, however, due to the typically high damping level, this does not result in permanent oscillations of increasing amplitude.

If devices are connected to the supply network in parallel, e.g. compensation systems, wind energy plant, etc., which permanently or temporarily generate harmonics in the frequency range stated above, stronger excitation of the resonance circuit may occur, as a result of which there is an increase of the harmonic voltage, which is superimposed on the mains voltage.

Result:

- Overload up to total failure of the X2 capacitors
- Impermissible charging of the link circuit with error messages, up to exceeding of the permissible link circuit voltage with total failure.

In both cases, permanent damage to the frequency inverter is possible

Information

Devices above 45 kW (Size 8 – 11)

For inverters of Size 8 to 11 **link circuit chokes** are available, which are used in place of the input choke. In the resonance circuit described above, there is no inductance due to the input choke, so that the resulting resonant frequency is in a non-critical high frequency range.

1.2.2 Operation of an SK 5xxE-...-O frequency inverter

The SK 5xxE-xxx-340-O is not equipped with an EMC mains filter and only has reduced X2-capacitors for the basic reduction of interference at the mains input. In "O" frequency inverters, the mains-side filtration is reduced to an absolute minimum, so that with the use of an input / mains choke, resonant frequencies in excess of the maximum permissible pulse frequency (16 kHz) of the frequency inverter result.

In this considerably higher frequency range, adequate damping can be assumed, as a result of which the resonance phenomena with the consequences described above is not to be expected.

A suitable bottom-mounted filter is available in order to comply with the EMC requirements for these inverters (please see chapter 8.3 "Electromagnetic compatibility (EMC)", (please see chapter 2.8 "Line filter").

1.2.3 Which type of inverter should be used?

There is no general answer to this question. In principle, an inverter with an integrated EMC-mains filter (...-A) is preferable, as the EMC requirements are fulfilled by this device. However, under certain circumstances an "...-O" inverter must be used.

In particular for critical (harmonic) mains supplies, or with the use of an input choke, (SK C11-...) an "...-O" inverter should be used.

How can critical mains supplies be recognised?

- a. Increased link circuit voltages in Standby or even overvoltage error messages indicate resonance effects. The actual applied voltage can be checked and investigated for plausibility via the information parameters of the frequency inverter (P728 - Input voltage/Mains voltage, P736 - Link circuit voltage, or P753 - Statistics for overvoltage/Number of E005 error messages).
- b. In the network there have already been failures of frequency inverters with damage to the link circuit capacitors or to the EMC mains filter circuits.
- c. Sliding contacts in power rails may cause brief power interruptions (e.g. transport carriages in high bay storage warehouses).

1.3 Delivery

Check the equipment **immediately** after delivery / unpacking for transport damage such as deformation or loose parts.





If there is any damage, contact the carrier immediately and carry out a thorough assessment.







Important! This also applies even if the packaging is undamaged.





1.4 Scope of supply







- Standard version:
- IP20
 - Integrated brake chopper
 - Integrated EMC mains filter for limit curve A1 or Category C2 (only inverters of type SK 5xxE-...-A)
 - Blanking cover for the technology unit slot
 - Screening terminal for control terminals
 - Covering for the control terminals
 - Size 1 to Size 7: Accessory bag with wall mounting brackets
 - Size 8 and above: miscellaneous electrical connection material
 - Screw (2.9 mm x 9.5 mm) for fastening the blanking cover or an optional SK TU3-... technology unit
 - Operating instructions on CD



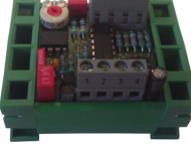

Available accessories:

	Designation	Example	Description
Control and parameterisation options	Technology units for attachment to the inverter		For commissioning, parameterisation and control of the device. Type SK TU3-CTR, SK TU3-PAR, SK CSX-0 (please see chapter 3.2 "Overview of technology units")
	Technology units for installation in the control cabinet		For commissioning, parameterisation and control of the device. Type SK CSX-3E, SK PAR-3E (please see chapter 3.2 "Overview of technology units")
	Hand-held control boxes		For control of the inverter, Typ SK POT- ... Refer to BU 0040
	NORD CON MS Windows® - based software		For commissioning, parameterisation and control of the device. Refer to www.nord.com NORD CON

Designation		Example	Description
Bus interfaces			Technology units which are clipped onto the inverter for: AS-Interface, CANopen, DeviceNet, InterBus, Profibus DP, EtherCat, Ethernet/IP, Profinet IO, Powerlink, Type SK TU3-... (please see chapter 3.2 "Overview of technology units")
Brake resistor	Chassis-mounted brake resistor		Dissipation of generated energy from the drive system by conversion into heat. Energy is generated by the braking processes, Type SK BR2- ... (please see chapter 2.6 "Brake resistor (BR)")
	Bottom-mounted brake resistor		Refer to: <i>Chassis-mounted brake resistor,</i> Type SK BR4- ... (please see chapter 2.6 "Brake resistor (BR)")
Choke	Output choke		Reduction of radiated interference (EMC) from the motor cable, compensation of cable capacitances, Type SK CO1- ... (please see chapter 2.7.2 "Output choke SK CO1")
	Input choke		Reduction of mains-induced harmonic components and charging currents, Type SK CI1... (please see chapter 2.7.1.2 "Input choke SK CI1-...")
	Link circuit choke		Reduction of mains-induced voltage distortions and harmonic components, Type SK DCL- ... (please see chapter 2.7.1.1 "Link circuit choke SK DCL-")

	Designation	Example	Description
Mains filter	Chassis-mounted mains filter		Reduction of radiated interference (EMC) Type SK HLD ... (please see chapter 2.8.3 "Line filter SK HLD")
	Bottom-mounted mains filter		Reduction of radiated interference (EMC) Type SK LF2 ... (please see chapter 2.8.2 "Mains filter SK LF2 (size 5 - 7)")
	Bottom-mounted combination filter		Reduction of radiated interference (EMC) and compensation of cable capacitances, Type SK NHD ... (please see chapter 2.8.1 "Mains filter SK NHD (up to size 4)")
Installation versions	Mounting rail mounting set		Set for mounting the inverter on a standard TS35 mounting rail (EN 50022), Type SK DRK1- ... (please see chapter 2.4 "Snap-on mounting rail kit SK DRK1-...")
	External heat sink kit		Heat sink kit for mounting on a ColdPlate inverter version (SK 5xxE...-CP). This enables waste heat to be directly removed from the control cabinet, Type SK TH1- ... (please see chapter 2.3 "External heat sink kit")

Designation	Example	Description
EMC Kit		Screening bracket for EMC-compliant connection of shielded cables, Type SK EMC2- ... (please see chapter 2.5 "EMC Kit")
Electronic brake rectifier		Direct control of electro-mechanical brakes Type SK EBGR-1 Refer to Link
IO extension		External IO extension (analog and digital) Type SK EBIOE-2 Refer to Link
Interface converter		Signal converter from RS232 → RS485, Type SK IC1-232/485 Refer to Link
Setpoint converter ± 10 V		Signal converter to convert bipolar to unipolar analog signals (only for FI Sizes 1 - 4), Type setpoint converter ± 10 V Refer to Link
Connection module V/F converter		Signal converter for conversion of the 0 – 10 V analog signals from a potentiometer into pulse signals for evaluation at the digital input of the frequency inverter (SK 500E ... SK 535E), Type connection module V/F converter Refer to Link
Connection module V/I converter		Signal converter to convert 0 – 10 V analog signals to 0 – 20 mA signals, for example for evaluation by a PLC with a current signal input, Type connection module V/F converter Refer to Link
RJ45 connection module		Adapter for single wire signal cables to RJ 45, Type WAGO Ethernet connection module with CAGE CLAMP connection (please see chapter 2.11 "RJ45 WAGO-Connection module")

Software (Free download)	NORD CON MS Windows® - based software		For commissioning, parametrisation and control of the device. Refer to www.nord.com NORD CON
	ePlan macros		Macros for producing electrical circuit diagrams Refer to www.nord.com ePlan
	Device master data		Device master data / device description files for NORD field bus options NORD fieldbus files
	S7 standard modules for PROFIBUS DP and PROFINET IO		Standard modules for NORD frequency converters Refer to www.nord.com NORD S7_files
	Standard modules for the TIA portal for PROFIBUS DP and PROFINET IO		Standard modules for NORD frequency converters <i>In preparation</i>

1.5 Safety and installation notes

The devices are operating materials intended for use in industrial high voltage systems, and are operated at voltages that could lead to severe injuries or death if they are touched.





The device and its accessories must only be used for the purpose which is intended by the manufacturer. Unauthorised modifications and the use of spare parts and additional equipment which has not been purchased from or recommended by the manufacturer of the device may cause fire, electric shock and injury.

All of the associated covers and protective devices must be used.



Installation and other work may only be carried out by qualified electricians with strict adherence to the operating instructions. Therefore keep these Operating Instructions at hand, together with all supplementary instructions for any options which are used, and give them to each user.

Local regulations for the installation of electrical equipment and accident prevention must be complied with.

1.5.1 Explanation of labels used

 DANGER	Indicates an immediate danger, which may result in death or serious injury.
 WARNING	Indicates a possibly dangerous situation, which may result in death or serious injury.
 CAUTION	Indicates a possibly dangerous situation, which may result in slight or minor injuries.
NOTICE	Indicates a possibly harmful situation, which may cause damage to the product or the environment.
 Note	Indicates hints for use and useful information.



1.5.2 List of safety and installation notes

 DANGER!	Electric shock
<p>The device operates with a dangerous voltage. Touching certain conducting components (connection terminals, contact rails and supply cables as well as the PCBs) will cause electric shock with possibly fatal consequences.</p> <p>Even when the motor is at a standstill (e.g. caused by an electronic block, blocked drive or output terminal short-circuit), the line connection terminals, motor terminals and braking resistor terminals (if present), contact rails, PCBs and supply cables may still conduct hazardous voltages. A motor standstill is not identical to electrical isolation from the mains.</p> <p>Only carry out installations and work if the device is disconnected from the voltage and wait at least 5 minutes after the mains have been switched off! (The equipment may continue to carry hazardous voltages for up to 5 minutes after being switched off at the mains).</p> <p>Follow the 5 Safety Rules (1. Switch off the power, 2. Secure against switching on, 3. Check for no voltage, 4. Earthing and short circuiting, 5. Cover or fence off neighbouring live components).</p>	
 DANGER!	Electric shock
<p>Even if the drive unit has been disconnected from the mains, a connected motor may rotate and possible generate a dangerous voltage. Touching electrically conducting components may then cause an electric shock with possible fatal consequences.</p> <p>Therefore prevent connected motors from rotating.</p>	
 WARNING	Electric shock
<p>The voltage supply of the device may directly or indirectly put it into operation, or touching electrically conducting components may then cause an electric shock with possible fatal consequences.</p> <p>Therefore, all poles of the voltage supply must be disconnected. For devices with a 3-phase supply, L1 / L2 / L3 must be disconnected. For devices with a single phase supply, L1 / N must be disconnected. For devices with a DC supply, -DC / +B must be disconnected. Also, the motor cables U / V / W must be disconnected.</p>	

**WARNING****Electric shock**

In case of a fault, insufficient earthing may cause an electric shock with possibly fatal consequences if the device is touched.

Because of this, the device is only intended for permanent connection and may not be operated without effective earthing connections which comply with local regulations for large leakage currents (> 3.5 mA).

EN 50178 / VDE 0160 stipulates the installation of a second earthing conductor or an earthing conductor with a cross-section of at least 10 mm². ( [TI 80-0011](#)), ( [TI 80-0019](#))

**WARNING****Danger of injury if motor starts**

With certain setting conditions, the device or the motor which is connected to it may start automatically when the mains are switched on. The machinery which it drives (press / chain hoist / roller / fan etc.) may then make an unexpected movement. This may cause various injuries, including to third parties.

Before switching on the mains, secure the danger area by warning and removing all persons from the danger area.

**CAUTION****Danger of burns**

The heat sink and all other metal components can heat up to temperatures above 70 °C.

Touching such components may cause local burns to the affected parts of the body (hands, fingers, etc.).

To prevent such injuries, allow sufficient time for cooling down before starting work - the surface temperature should be checked with suitable measuring equipment. In addition, keep a sufficient distance from adjacent components during installation, or install protection against contact.

NOTICE**Damage to the device**

For single phase operation (115 / 230 V) the mains impedance must be at least 100 µH for each conductor. If this is not the case, a mains choke must be installed.

Failure to comply with this may cause damage to the device due to impermissible currents in the components.

NOTICE**EMC - Interference**

The device is a product which is intended for use in an industrial environment and is subject to sales restrictions according to IEC 61800-3. Use in a residential environment may require additional EMC measures. ( Document [TI 80_0011](#))

For example, electromagnetic interference can be reduced by the use of an optional mains filter.

NOTICE**Leakage and residual currents**

Due to their principle of operation (e.g. due to integrated mains filters, mains units and capacitors), the devices generate leakage currents. For correct operation of the device on a current-sensitive RCD, the use of an all-current sensitive earth leakage circuit breaker (Type B) compliant with EN 50178 / VDE 0160 is necessary.

**Information****Operation on TN- / TT- / IT- networks**

The devices are suitable for operation on TN or TT networks as well as for IT networks with the configuration of the integrated mains filter. ( Section 2.9.2 "Adaptation to IT networks")

i Information

Maintenance

In normal use, soft starter are maintenance-free.

The cooling surfaces must be regularly cleaned with compressed air if the ambient air is dusty.

In the event of taking out of service or storage for long periods, special measures must be taken (📖 Section 9.1 "Maintenance Instructions").

Failure to do this will damage these components and will cause a considerable reduction of the service life - including the immediate destruction of the devices.

1.6 Standards and approvals

All devices of the entire series comply with the standards and directives listed below.





Approval	Directive	Applied standards	Certificates	Label
CE <i>(European Union)</i>	Low Voltage 2014/35/EU	EN 61800-5-1 EN 60529 EN 61800-3 EN 63000 EN 61800-9-1 EN 61800-9-2	C310600	
	EMC 2014/30/EU			
	RoHS 2011/65/EU			
	Delegated directive (EU) 2015/863			
	Ecodesign 2009/125/EC			
	Regulation (EU) Ecodesign 2019/1781			
UL <i>(USA)</i>		UL 61800-5-1	E171342	
CSA <i>(Canada)</i>		C22.2 No.274-13	E171342	
RCM <i>(Australia)</i>	F2018L00028	EN 61800-3	133520966	
EAC <i>(Eurasia)</i>	TR CU 004/2011, TR CU 020/2011	IEC 61800-5-1 IEC 61800-3	EAЭC N RU Д- DE.HB27.B.0272 1/20	

Table 4: Standards and approvals

1.7 UL and cUL (CSA) approval

File No. E171342

Categorisation of protective devices approved by the UL according to United States Standards for the inverters described in this manual is listed below with essentially the original wording. The categorisation of individually relevant fuses or circuit breakers can be found in this manual under the heading "Electrical Data". All devices include motor overload protection.

1.8 (📖 section 7.2 "

Technical data for determining the energy efficiency level

The following tables relate to the provisions of the Ecodesign EU Regulation 2019/1781.

Manufacturer	FI type	Rel. losses (rel. motor stator frequency / rel. torque-producing current)								Standby	IE rating
		90/100	90/50	50/100	50/50	50/25	0/100	0/50	0/25		
Getriebebau NORD GmbH & Co. KG	SK 5xxE-	[%]	[%]	[%]	[%]	[%]	[%]	[%]	[%]	[W]	
	250-323	4,8	4,1	4,3	3,9	3,8	4,0	3,7	3,7	6,2	IE2
	370-323	4,1	3,3	3,6	3,2	3,1	3,3	3,0	3,0	6,2	IE2
	550-323	3,6	2,8	3,2	2,7	2,6	2,9	2,5	2,5	6,2	IE2
	750-323	3,4	2,6	2,9	2,4	2,3	2,6	2,2	2,2	6,2	IE2
	111-323	3,1	2,1	2,6	1,9	1,6	2,2	1,8	1,6	6,5	IE2
	151-323	3,1	2,1	2,6	1,9	1,6	2,2	1,7	1,5	6,5	IE2
	221-323	3,2	2,1	2,7	1,9	1,6	2,4	1,8	1,6	6,5	IE2
	301-323	3,0	2,0	2,5	1,8	1,5	2,2	1,6	1,4	6,9	IE2
	401-323	3,0	1,9	2,4	1,7	1,3	2,1	1,5	1,3	6,9	IE2
	551-323	4,2	3,0	3,7	2,8	2,4	3,3	2,6	2,3	50,0	IE2
	751-323	4,0	2,4	3,3	2,2	1,8	2,9	2,0	1,7	50,0	IE2
	112-323	4,0	2,3	3,4	2,2	1,7	3,1	2,0	1,7	50,0	IE2
	152-323	3,4	1,9	2,7	1,6	1,3	2,3	1,4	1,2	50,0	IE2
	182-323	3,5	1,9	2,9	1,7	1,3	2,4	1,5	1,2	50,0	IE2
	550-340	3,9	3,4	3,7	3,3	3,2	3,6	3,2	3,2	8,5	IE2
	750-340	3,4	2,7	3,2	2,6	2,4	3,1	2,5	2,3	8,5	IE2
	111-340	3,1	2,3	2,9	2,2	2,0	2,7	2,2	2,0	8,9	IE2
	151-340	3,0	2,2	2,8	2,1	1,8	2,6	2,0	1,8	8,9	IE2
	221-340	2,9	2,0	2,6	1,9	1,6	2,4	1,8	1,5	8,9	IE2
	301-340	2,9	2,0	2,6	1,9	1,6	2,4	1,8	1,5	10,6	IE2
	401-340	2,8	1,9	2,6	1,8	1,5	2,3	1,7	1,4	10,6	IE2
	551-340	2,5	1,4	2,2	1,3	1,0	2,0	1,2	1,0	11,8	IE2
	751-340	2,4	1,3	2,1	1,2	0,9	1,8	1,1	0,9	11,8	IE2
	112-340	2,7	1,6	2,4	1,5	1,2	2,2	1,5	1,2	24,9	IE2
	152-340	2,5	1,5	2,3	1,4	1,1	2,0	1,3	1,1	24,9	IE2
	182-340	2,7	1,6	2,4	1,5	1,2	2,2	1,4	1,1	24,6	IE2
	222-340	2,7	1,5	2,4	1,4	1,1	2,1	1,3	1,0	24,6	IE2
	302-340	2,3	1,3	2,0	1,2	0,9	1,9	1,1	0,9	30,7	IE2
	372-340	2,6	1,5	2,3	1,4	1,0	2,1	1,3	1,0	30,7	IE2
	452-340	1,7	0,9	1,5	0,8	0,6	1,4	0,8	0,6	21,1	IE2
	552-340	1,8	0,9	1,6	0,8	0,6	1,4	0,7	0,5	21,1	IE2
752-340	2,0	1,0	1,7	0,9	0,6	1,5	0,8	0,6	25,2	IE2	
902-340	2,1	1,0	1,7	0,9	0,6	1,5	0,8	0,6	25,2	IE2	
113-340	1,7	0,8	1,4	0,8	0,5	1,2	0,7	0,5	32,0	IE2	
133-340	1,9	0,9	1,6	0,9	0,6	1,4	0,8	0,6	32,0	IE2	
163-340	2,0	1,0	1,7	0,9	0,6	1,4	0,8	0,6	49,8	IE2	
203-340	2,1	1,0	1,7	0,9	0,6	1,4	0,7	0,5	60,5	IE2	

Manuf	FI type	Output power	Indicative output power	Rated output current	Max. operating temperature	Rated input frequency	Rated input voltage range
Getriebebau NORD GmbH & Co. KG	SK 5xxE-	[kVA]	[kW]	[A]	[°C]	[Hz]	[V]
	250-323	0,5	0,3	1,3	40	50	200 V - 240 V
	370-323	0,7	0,4	1,8	40	50	200 V - 240 V
	550-323	1,0	0,6	2,6	40	50	200 V - 240 V
	750-323	1,3	0,8	3,4	40	50	200 V - 240 V
	111-323	1,7	1,1	4,5	40	50	200 V - 240 V
	151-323	2,3	1,5	6,0	40	50	200 V - 240 V
	221-323	3,3	2,2	8,7	40	50	200 V - 240 V
	301-323	4,4	3,0	11,7	40	50	200 V - 240 V
	401-323	5,9	4,0	15,3	40	50	200 V - 240 V
	551-323	7,9	5,5	20,8	40	50	200 V - 240 V
	751-323	10,0	7,5	26,1	40	50	200 V - 240 V
	112-323	14,4	11,0	37,8	40	50	200 V - 240 V
	152-323	19,5	15,0	51,1	40	50	200 V - 240 V
	182-323	23,9	18,5	62,6	40	50	200 V - 240 V
	550-340	1,2	0,6	1,7	40	50	380 V – 480 V
	750-340	1,6	0,8	2,3	40	50	380 V – 480 V
	111-340	2,1	1,1	3,1	40	50	380 V – 480 V
	151-340	2,8	1,5	4,0	40	50	380 V – 480 V
	221-340	3,8	2,2	5,5	40	50	380 V – 480 V
	301-340	5,2	3,0	7,5	40	50	380 V – 480 V
	401-340	6,6	4,0	9,5	40	50	380 V – 480 V
	551-340	8,7	5,5	12,5	40	50	380 V – 480 V
	751-340	11,1	7,5	16,0	40	50	380 V – 480 V
	112-340	16,6	11,0	24,0	40	50	380 V – 480 V
	152-340	21,5	15,0	31,0	40	50	380 V – 480 V
	182-340	26,3	18,5	38,0	40	50	380 V – 480 V
	222-340	31,9	22,0	46,0	40	50	380 V – 480 V
	302-340	41,6	30,0	60,0	40	50	380 V – 480 V
	372-340	52,0	37,0	75,0	40	50	380 V – 480 V
	452-340	62,4	45,0	90,0	40	50	380 V – 480 V
	552-340	76,2	55,0	110,0	40	50	380 V – 480 V
752-340	103,9	75,0	150,0	40	50	380 V – 480 V	
902-340	124,7	90,0	180,0	40	50	380 V – 480 V	
113-340	135,4	110,0	205,6	40	50	380 V – 480 V	
133-340	162,1	132,0	246,3	40	50	380 V – 480 V	
163-340	196,0	160,0	297,9	40	50	380 V – 480 V	
203-340	244,5	200,0	371,5	40	50	380 V – 480 V	

Electrical data ")

UL / cUL conditions according to the report

i Information

Art der Information (optional)

"Integral solid state short circuit protection does not provide branch circuit protection. Branch circuit protection must be provided in accordance with manufacturer instructions, the National Electric Code and any additional local codes."

"Use 75°C Copper Conductors Only"

„These products are intended for use in a pollution degree 2 environment“

"Maximum Surrounding Air Temperature 40°C"

"Intended to be connected in the field only to an isolated secondary sources rated 24Vdc. Fuse in accordance with UL 248 rated max. 4 A must be provided externally between the isolated source and this device input".

Size	valid	description
1 - 4	For 120 V, 240 V, 400 V, 500 V models only:	"Suitable For Use On A Circuit Capable Of Delivering Not More Than 5000 rms Symmetrical Amperes, 480 Volts Maximum" and minimum one of the two following alternatives. "When Protected by Fuses manufactured by Bussmann, type _____", as listed in ¹⁾ . "When Protected by class J Fuses, rated _____ Amperes, and 600 Volts", as listed in ¹⁾ .
	For 120 V models only:	"Suitable For Use On A Circuit Capable Of Delivering Not More Than 100 000 rms Symmetrical Amperes, 120 Volts Maximum, When Protected by High-Interrupting Capacity, Current Limiting Class CC, G, J, L, R, T, etc. Fuses". The specific fuse ratings are shown in ¹⁾ . "Suitable For Use On A Circuit Capable Of Delivering Not More Than 10 000 rms Symmetrical Amperes, 120 Volts Maximum, When Protected by A Circuit Breaker Having An Interrupting Rating Not Less Than 10 000 rms Symmetrical Amperes, 480 Volts Maximum". The specific Circuit Breaker ratings are shown in ¹⁾ .
	For 240 V models only:	For 240V models only: "Suitable For Use On A Circuit Capable Of Delivering Not More Than 100 000 rms Symmetrical Amperes, 240 Volts Maximum, When Protected by High-Interrupting Capacity, Current Limiting Class CC, G, J, L, R, T, etc. Fuses". The specific fuse ratings are shown in ¹⁾ . "Suitable For Use On A Circuit Capable Of Delivering Not More Than 10 000 rms Symmetrical Amperes, 240 Volts Maximum, When Protected by A Circuit Breaker Having An Interrupting Rating Not Less Than 10 000 rms Symmetrical Amperes, 480 Volts Maximum". The specific Circuit Breaker ratings are shown in ¹⁾ .
	For 480 V models only:	"Suitable For Use On A Circuit Capable Of Delivering Not More Than 100 000 rms Symmetrical Amperes, 480 Volts Maximum, When Protected by High-Interrupting Capacity, Current Limiting Class CC, G, J, L, R, T, etc. Fuses". The specific fuse ratings are shown in ¹⁾ . "Suitable For Use On A Circuit Capable Of Delivering Not More Than 10 000 rms Symmetrical Amperes, 480 Volts Maximum, When Protected by A Circuit Breaker Having An Interrupting Rating Not Less Than 10 000 rms Symmetrical Amperes, 480 Volts Maximum". The specific Circuit Breaker ratings are shown in ¹⁾ .
	For 500 V models only:	"Suitable For Use On A Circuit Capable Of Delivering Not More Than 100 000 rms Symmetrical Amperes, 500 Volts Maximum, When Protected by High-Interrupting Capacity, Current Limiting Class CC, G, J, L, R, T, etc. Fuses". The specific fuse ratings are shown in ¹⁾ .

Size	valid	description
5 - 6	For 240 V models only:	<p>"Suitable For Use On A Circuit Capable Of Delivering Not More Than 5000 rms Symmetrical Amperes, 240 Volts Maximum."</p> <p>"Suitable For Use On A Circuit Capable Of Delivering Not More Than 65000 rms Symmetrical Amperes, 240 V Maximum When Protected By CC, J, T or R Class Fuses or When Protected By A Circuit Breaker Having An Interrupting Rating Not Less Than 65000 rms Symmetrical Amperes, 240 Volts Maximum."</p> <p>"The specific fuse/circuit breaker sizes for each models are shown in ¹⁾. Voltage rating of the fuses and circuit breakers must at least be suitable for the input voltage."</p>
	For 480 V models only:	<p>"Suitable For Use On A Circuit Capable Of Delivering Not More Than 5000 rms Symmetrical Amperes, 480 Volts Maximum."</p> <p>"Suitable For Use On A Circuit Capable Of Delivering Not More Than 65000 rms Symmetrical Amperes, 480 V Maximum When Protected By CC, J, T or R Class Fuses or When Protected By A Circuit Breaker Having An Interrupting Rating Not Less Than 65000 rms Symmetrical Amperes, 480/277 Volts Y Maximum."</p> <p>"The specific fuse/circuit breaker sizes for each models are shown in ¹⁾. Voltage rating of the fuses and circuit breakers must at least be suitable for the input voltage."</p> <p>"480V models only for use in WYE 480/277V source, when protected by Circuit Breakers."</p>
	For 500 V models only:	<p>"Suitable For Use On A Circuit Capable Of Delivering Not More Than 5000 rms Symmetrical Amperes, 500 Volts Maximum."</p> <p>"Suitable For Use On A Circuit Capable Of Delivering Not More Than 65000 rms Symmetrical Amperes, 500 V Maximum When Protected By CC, J, T or R Class Fuses or When Protected By A Circuit Breaker Having An Interrupting Rating Not Less Than 65000 rms Symmetrical Amperes, 480/277 Volts Y Maximum."</p> <p>"The specific fuse/circuit breaker sizes for each models are shown in ¹⁾. Voltage rating of the fuses and circuit breakers must at least be suitable for the input voltage."</p> <p>"480V models only for use in WYE 480/277V source, when protected by Circuit Breakers."</p>
7	For 240 V models only:	<p>"Suitable For Use On A Circuit Capable Of Delivering Not More Than 100 000 rms Symmetrical Amperes, 240 Volts Maximum, When Protected by High-Interrupting Capacity, Current Limiting Class CC, G, J, L, R, T, etc. Fuses". The specific fuse ratings are shown in ¹⁾.</p> <p>"Suitable For Use On A Circuit Capable Of Delivering Not More Than 65 000 rms Symmetrical Amperes, 240 Volts Maximum, When Protected by A Circuit Breaker Having An Interrupting Rating Not Less Than 65 000 rms Symmetrical Amperes, 480 Volts Maximum". The specific Circuit Breaker ratings are shown in ¹⁾.</p>
	For 480 V models only:	<p>"Suitable For Use On A Circuit Capable Of Delivering Not More Than 100 000 rms Symmetrical Amperes, 480 Volts Maximum, When Protected by High-Interrupting Capacity, Current Limiting Class CC, G, J, L, R, T, etc. Fuses". The specific fuse ratings are shown in ¹⁾.</p> <p>"Suitable For Use On A Circuit Capable Of Delivering Not More Than 65 000 rms Symmetrical Amperes, 480 Volts Maximum, When Protected by A Circuit Breaker Having An Interrupting Rating Not Less Than 65 000 rms Symmetrical Amperes, 480 Volts Maximum". The specific Circuit Breaker ratings are shown in ¹⁾.</p>

Size	valid	description
8 – 11	For 480 V models only:	<p>“Suitable For Use On A Circuit Capable Of Delivering Not More Than 10 000 (18 000 for cat. No. ...-163-340) rms Symmetrical Amperes, 480 Volts Maximum” and minimum one of the two following alternatives.</p> <p>“When Protected by class RK5 Fuses or faster, rated _____ Amperes, and 480 Volts”, as listed in ¹⁾.</p> <p>“When Protected by class J Fuses or faster, rated _____ Amperes, and 480 Volts”, as listed in ¹⁾.</p> <p>“When Protected by Circuit Breaker (inverse time trip type) in accordance with UL 489, rated _____ Amperes, and 480 Volts”, as listed in ¹⁾.</p> <p>“Suitable For Use On A Circuit Capable Of Delivering Not More Than 10 000 (18 000 for cat. No. ...-163-340) rms Symmetrical Amperes, 480 Volts Maximum”</p> <p>“When Protected by Circuit Breaker (inverse time trip type) in accordance with UL 489, rated _____ Amperes, and 480 Volts”, as listed in ¹⁾.</p>
		<p>“Suitable For Use On A Circuit Capable Of Delivering Not More Than 100 000 rms Symmetrical Amperes, 480 Volts Maximum, When Protected by High-Interrupting Capacity, Current Limiting Class CC, G, J, L, R, T, etc. Fuses”. The specific fuse ratings are shown in ¹⁾.</p>
		<p>“Suitable For Use On A Circuit Capable Of Delivering Not More Than 65 000 rms Symmetrical Amperes, 480 Volts Maximum, When Protected by A Circuit Breaker Having An Interrupting Rating Not Less Than 65 000 rms Symmetrical Amperes, 480 Volts Maximum”. The specific Circuit Breaker ratings are shown in ¹⁾.</p>

1)  7.2

1.9 Type code / nomenclature

Unique type codes have been defined for the individual modules and devices. These provide individual details of the device type and its electrical data, protection class, fixing version and special versions. A differentiation is made according to the following groups:



Frequency inverter



Option module (Technology Unit)

1.9.1 Type plate

All of the information which is relevant for the device, including information for the identification of the device can be obtained from the type plate.

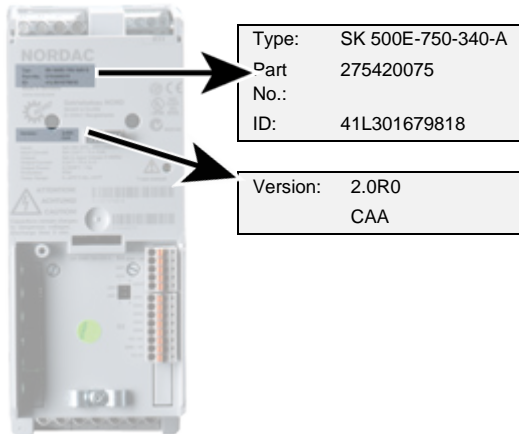

Type:	Type / designation
Part No.:	Part Number
ID:	Identification number
Version:	Software / Hardware version

1.9.2 Frequency inverter type code

SK 530E-370-323-A(-CP)

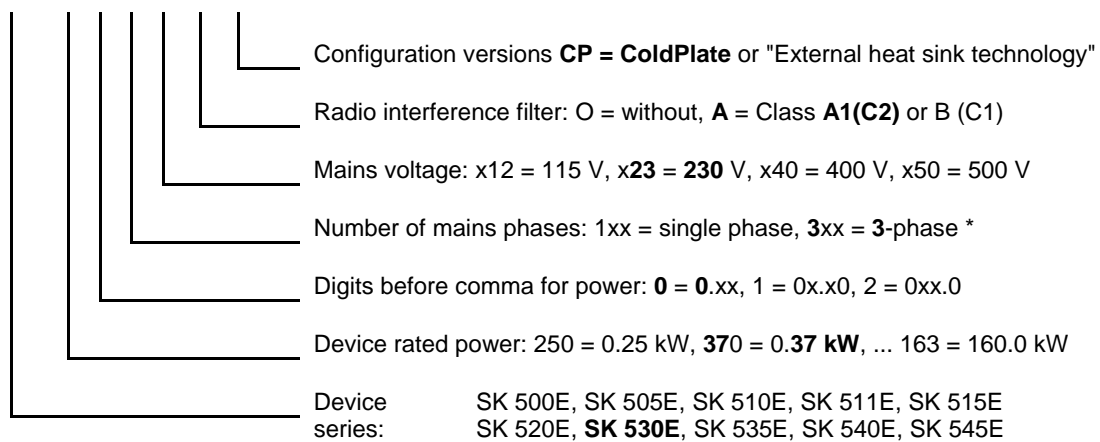

- (...) Options, only implemented if required.
- *) Designation - 3 - also includes combined devices which are intended for single and three-phase operation (please refer to the technical data)

1.9.3 Optional technology units (module type codes)

SK TU3-CAO(-...)

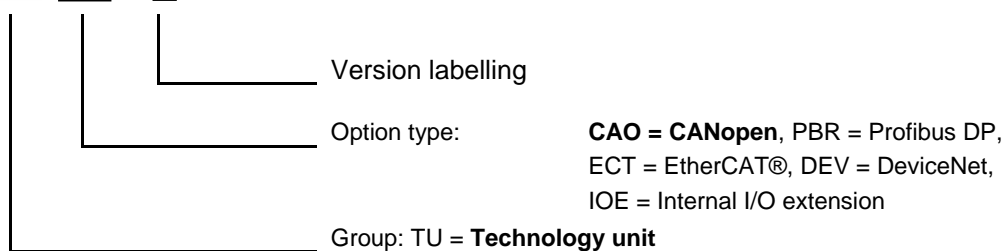

- (...) Options, only implemented if required.

2 Assembly and installation

SK 500E frequency inverters are available in various sizes depending on the output. Attention must be paid to a suitable position when installing.

The equipment requires sufficient ventilation to protect against overheating. For this the minimum guideline distances from adjacent components above and below the frequency inverter, which could obstruct the air flow apply. (above > 100 mm, below > 100 mm)

Distance from device: Mounting can be immediately next to each other. However, for the use of brake resistances mounted below the frequency inverter (not possible with ...-CP devices), the greater width must be taken into consideration, particularly in combination with temperature switches on the brake resistor!

Installation position: The installation position is normally vertical. It must be ensured that the cooling ribs on the rear of the frequency inverter are covered with a flat surface to provide good convection.



Warm air must be vented above the device!

Fig. 1 Mounting distances for SK 5xxE

If several inverters are arranged above each other, it must be ensured that the upper air entry temperature limit is not exceeded (chapter 7). If this is the case, it is recommended that an "obstacle" (e.g. a cable duct) is mounted between the inverters so that the direct air flow (rising warm air) is impeded.

Heat dissipation: If the frequency inverter is installed in a control cabinet, adequate ventilation must be ensured. The heat dissipation in operation is approx. 5% (according to the size and equipment of the device) of the rated power of the frequency inverter.

2.1 SK 5xxE, standard version

Normally the frequency inverter is mounted directly on the rear wall of a control cabinet. For this, two, or for Size 5 to 7 four, suitable wall-mounting brackets are supplied, which must be pushed into the heat sink on the rear of the inverter. Above Size 8, the mounting device is already integrated.

Alternatively, for Size 1 to 4 the wall mounting brackets can be inserted at the side of the cooling element in order to minimise the necessary depth of the control cabinet.

In general, care must be taken that the rear of the cooling element is covered with a flat surface and that the device is mounted vertically. This enables optimum convection, which ensures fault-free operation.



Device type	Size	Housing dimensions			Wall-mounting		
		A	B	C	D	E 1	∅
SK 5xxE-250- ... to SK 5xxE-750- ...	Size 1	186	74 ²⁾	153	220	/	5.5
SK 5xxE-111- ... to SK 5xxE-221- ...	Size 2	226	74 ²⁾	153	260	/	5.5
SK 5xxE-301- ... to SK 5xxE-401- ...	Size 3	241	98	181	275	/	5.5
SK 5xxE-551- 340... to SK 5xxE-751- 340...	Size 4	286	98	181	320	/	5.5
SK 5xxE-551- 323... to SK 5xxE-751- 323...	Size 5	327	162	224	357	93	5.5
SK 5xxE-112- 340... to SK 5xxE-152- 340...	Size 5	327	162	224	357	93	5.5
SK 5xxE-112- 323...	Size 6	367	180	234	397	110	5.5
SK 5xxE-182- 340... to SK 5xxE-222- 340...	Size 6	367	180	234	397	110	5.5
SK 5xxE-152- 323... to SK 5xxE-182- 323...	Size 7	456	210	236	485	130	5.5
SK 5xxE-302- 340... to SK 5xxE-372- 340...	Size 7	456	210	236	485	130	5.5
SK 5xxE-452- 340... to SK 5xxE-552- 340...	Size 8	598	265	286	582	210	8.0
SK 5xxE-752- 340... to SK 5xxE-902- 340...	Size 9	636	265	286	620	210	8.0
SK 5xxE-113- 340... to SK 5xxE-133- 340...	Size 10	720	395	292	704	360	8.0
SK 5xxE-163- 340...	Size 11	799	395	292	783	360	8.0

400 V (...-340...) and 500 V (...-350...) - FI:
identical dimensions and weights

All dimensions in [mm]

- 1) Size 10 and 11: The stated value corresponds to the distance between the outer fasteners. A third fastening hole is provided in the middle
- 2) For the use of bottom-mounted brake resistors = 88 mm

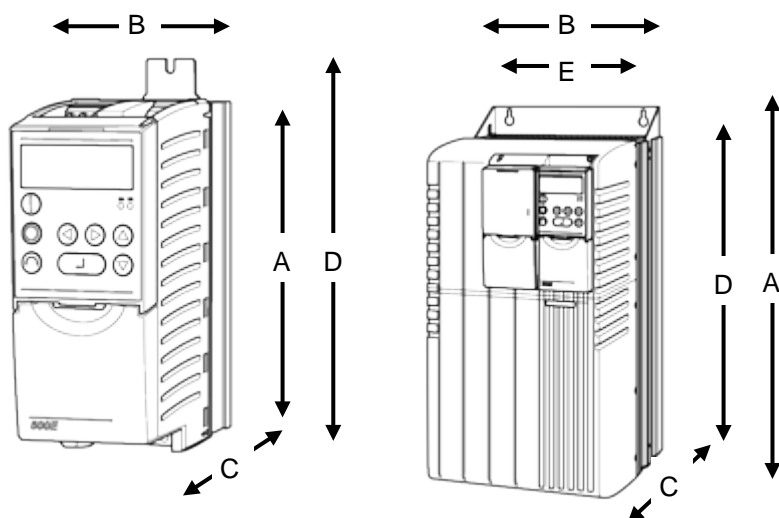

A=	Total length ¹⁾
B=	Total width ¹⁾
C=	Total height ¹⁾
D=	Longitudinal hole spacing ²⁾
E=	Lateral hole spacing ²⁾

- 1) Delivery condition
- 2) Fixing dimensions

2.2 SK 5xxE...-CP in ColdPlate version

Instead of a cooling element/fan, ColdPlate versions of the frequency inverter have a flat metal plate on the rear side which is mounted on an existing mounting plate (e.g. the rear wall of the control cabinet) so as to provide thermal conduction. A liquid cooling medium (water, oil) may also be passed through the mounting surface. In this way, not only is the waste heat from the frequency inverter dissipated more effectively, but also the waste heat from the inverter is prevented from remaining inside the control cabinet. In addition to the optimisation of the power reserved and the service life of the inverter, this also causes less thermal load on the inside of the control cabinet.

A further advantage of the ColdPlate version is the reduced installation depth of the device and the fact that in general, there is no need for a fan on the frequency inverter.

Bottom-mounted brake resistors (SK BR4-...) cannot be mounted directly.

Frequency inverter type	Size	Envelope dimensions [mm]			ColdPlate dimensions [mm]				Weight Approx. [kg]
		A / H	B	C	h1	h2	u / k	Thickness	
SK 5xxE-250- ...-CP SK 5xxE-750- ...-CP	1	182	95	119	91	-	5.5	10	1.3
SK 5xxE-111- ...-CP SK 5xxE-221- ...-CP	2	222	95	119	111	-	5.5	10	1.6
SK 5xxE-301- ...-CP SK 5xxE-401- ...-CP	3	237	120	119	75.33	75.33	5.5	10	1.9
SK 5xxE-551- 340...-CP SK 5xxE-751- 340...-CP	4	282	120	119	90.33	90.33	5.5	10	2.3

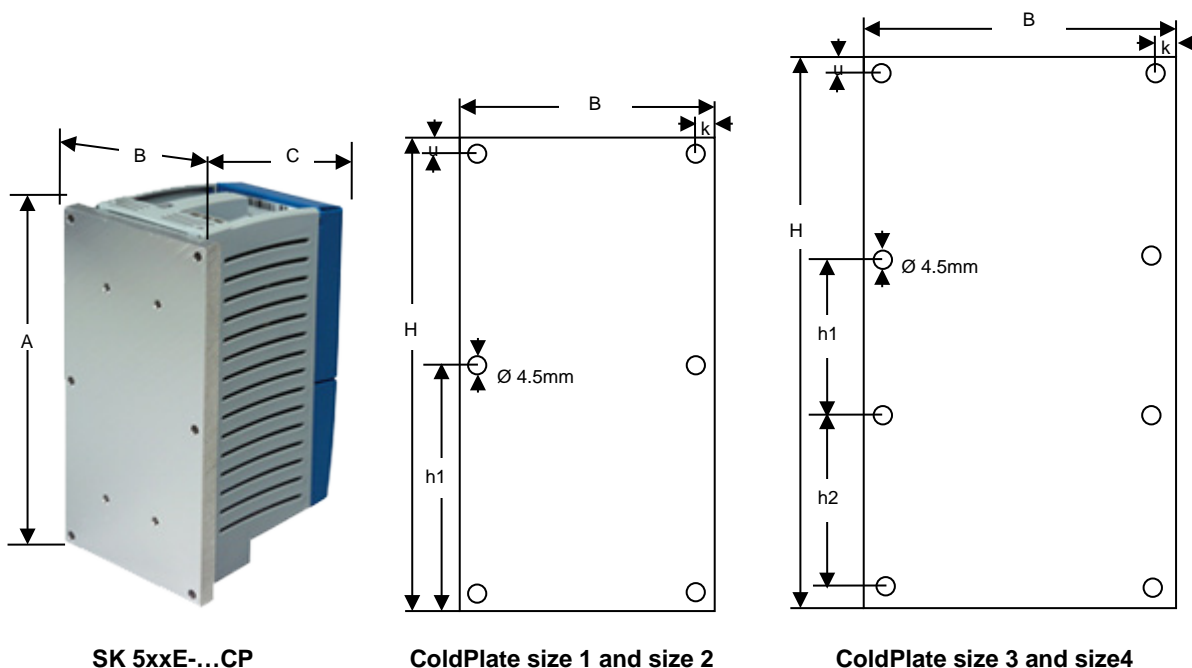

(Please see also chapter 7.4 "General conditions for ColdPlate technology".)

2.3 External heat sink kit

External heat sink technology is an optional supplement for ColdPlate devices. This is used if an external cooling system is provided, but no liquid-cooled mounting plate is available. A cooling element is mounted on the ColdPlate device, which passes through an opening in the rear panel of the control cabinet into the exterior air-cooled environment. Convection takes place outside of the control cabinet, which results in the same advantages as with ColdPlate technology.



Frequency inverter type	Size	Type External heat sink kit	Part. No.
SK 5xxE-250- ...-CP SK 5xxE-750- ...-CP	1	SK TH1-1	275999050
SK 5xxE-111- ...-CP SK 5xxE-221- ...-CP	2	SK TH1-2	275999060

Scope of delivery

- 1= Heat sink
- 2= Gasket
- 3= Heat-conducting paste
- 4= Cylindrical-head screws with internal hexagon socket M4x16 (4x)

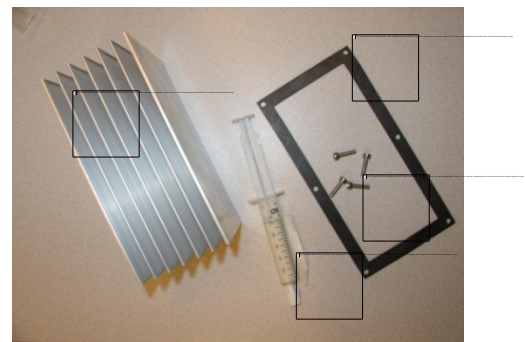

Dimensions

Type External heat sink kit	Heat sink dimensions [mm]			Weight Heat sink Approx. [kg]
	H _k	B _k	T _k	
SK TH1-1	157	70	100	1.5
SK TH1-2	200	70	110	1.7

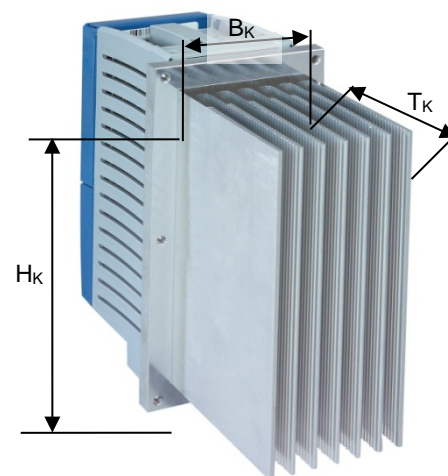

Assembly

For installation, a hole with the size of the heat sink must be made in the wall of the control cabinet (note the load bearing capacity).

1. Apply heat-conducting paste to the ColdPlate of the SK 5xxE;
2. firmly fasten the heat sink to the ColdPlate with the 4 enclosed screws;
3. remove any heat conducting paste which exudes;
4. Place the seal between the frequency inverter and the wall of the control cabinet (inside of the control cabinet);
5. Insert the frequency inverter and guide the external heat sink out of the control cabinet through the hole in the wall of the control cabinet;
6. Fasten the frequency inverter to the wall of the control cabinet through all of the 6 or 8 holes in the ColdPlate.

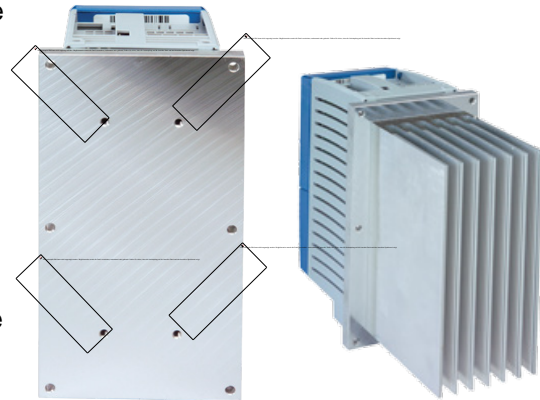

Information

Protection class IP54

With correct installation, the control cabinet achieves IP54 from the outside at the point of installation.

2.4 Snap-on mounting rail kit SK DRK1-...

The snap-on mounting rail set SK DRK1-1 enables size 1 or 2 frequency inverters to be mounted on a standard TS35 (EN 50022) mounting rail.

Frequency inverter type	Size	Type Snap-on rail mounting kit	Part. No.
SK 5xxE-250- ... SK 5xxE-750- ...	1	SK DRK1-1	275999030
SK 5xxE-111- ... SK 5xxE-221- ...	2	SK DRK1-2	275999040



Scope of delivery

- 1= Adapter for snap-on rail mounting
- 2= Clamp
- 3= Spacer
- 4= Fastening plate
- 5= Screws(2x)

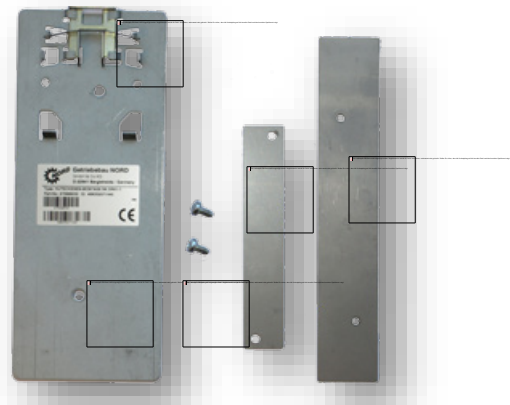

Assembly

1. Push the fastening plate (4) into the guide on the heat sink (arrow);
2. place the spacer plate (3) on the fastening plate (4);
3. connect the snap-on rail mounting adapter (1) and the components (3) + (4) with screws (5).

During assembly, take care that the stirrup (2) points upwards (mains connection side of the inverter).

Then the inverter can be clipped directly onto the snap-on rail. To release the frequency inverter, the stirrup (2) must be pulled a few millimetres out of the snap-on rail.

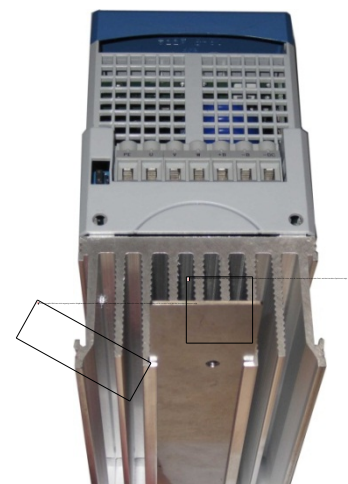

2.5 EMC Kit

For optimum EMC-compliant wiring, the optional EMC Kit must be used.

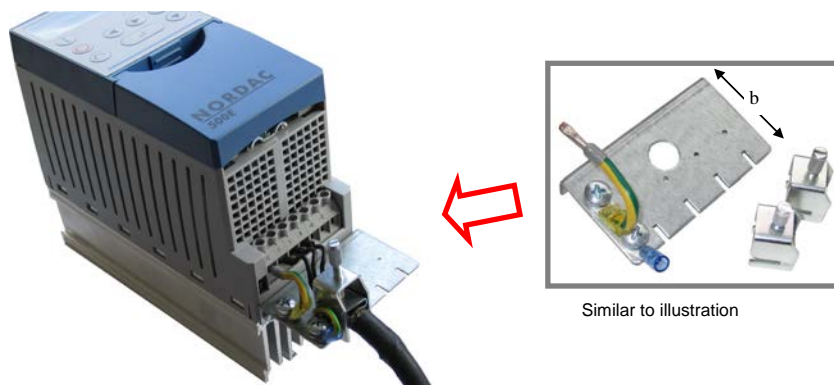

Fig. 2: EMC Kit SK EMC2-x

Frequency inverter type	Size	EMC Kit	Document	Dimension "b"
SK 5xxE-250- ... SK 5xxE-750-	Size 1	SK EMC 2-1	TI 275999011	42 mm
SK 5xxE-111- ... SK 5xxE-221-	Size 2	Part No. 275999011		
SK 5xxE-301- ... SK 5xxE-401-	Size 3	SK EMC 2-2	TI 275999021	42 mm
SK 5xxE-551-340- ... SK 5xxE-751- 340-	Size 4	Part No. 275999021		
SK 5xxE-551-323- ... SK 5xxE-751- 323- SK 5xxE-112-340- ... SK 5xxE-152- 340-	Size 5	SK EMC 2-3 Part No. 275999031	TI 275999031	52 mm
SK 5xxE-112-323- SK 5xxE-182-340- ... SK 5xxE-222- 340-	Size 6	SK EMC 2-4 Part No. 275999041	TI 275999041	57 mm
SK 5xxE-152-323- ... SK 5xxE-182- 323- SK 5xxE-302-340- ... SK 5xxE-372- 340-	Size 7	SK EMC 2-5 Part No. 275999051	TI 275999051	57 mm
SK 5xxE-452-340- ... SK 5xxE-902- 340-	Size 8/9	SK EMC 2-6 Part No. 275999061	TI 275999061	100 mm
SK 5xxE-113-340- ... SK 5xxE-163- 340-	Size 10/11	SK EMC 2-7 Part No. 275999071	TI 275999071	82 mm

Table 5: EMC Kit SK EMC2-x

Information

The EMC Kit cannot be combined with ...-CP (ColdPlate) devices. Any cable shielding must be earthed to a large area of the mounting surface.

Alternatively, the EMC kit can also be used purely as a strain relief (e.g. for the connection cables of a bus system) (observe the bending radii).

2.6 Brake resistor (BR)

CAUTION

Danger of burns

The heat sink and all other metal components can heat up to temperatures above 70 °C.

Touching such components may cause local burns to the affected parts of the body (hands, fingers, etc.).

To prevent such injuries, allow sufficient time for cooling down before starting work - the surface temperature should be checked with suitable measuring equipment. In addition, keep a sufficient distance from adjacent components during installation, or install protection against contact.

During dynamic braking (frequency reduction) of a three-phase motor, electrical energy is returned to the inverter. An external brake resistor can be used in order to prevent the FI from being shut down due to overvoltage. With this, the integrated brake chopper (electronic switch) pulses the intermediate circuit voltage (switching wave approx. 420 V / 775 V (/825 V) DC, according to the mains voltage) (115 V, 230 V/400 V(/500 V)) to the brake resistor. Here the excess energy is converted into heat.

For inverter powers **up to 7.5 kW** (230 V: bis 4,0 kW) a standard bottom-mounted resistor (**SK BR4-...**, **IP54**) can be used. Approval: UL, cUL

Note: Brake resistors cannot be directly mounted below ...-CP (ColdPlate) devices.



Fig. 3: Bottom-mounted brake resistor SK BR4-...

For frequency inverters **above 3kW** chassis-mounted resistors (**SK BR2-...**, **IP20**) are also available. These must be mounted in the control cabinet, close to the frequency inverter. Approval: UL, cUL



Fig. 4: chassis brake resistor SK BR2-...

2.6.1 Electrical data for brake resistors

Item	Type	Part. No.	R [Ω]	P [W]	Short circuit power [kW]				Connecting cable/ terminals
					1.2 s	7.2 s	30 s	72 s	
1	SK BR4-240/100	275991110	240	100	2.2	0.8	0.3	0.15	2 x 1.9 mm ² , AWG 14/19 L = 0.5 m
2	SK BR4-150/100	275991115	150	100	2.2	0.8	0.3	0.15	
3	SK BR4-75/200	275991120	75	200	4.4	1.6	0.6	0.3	
4	SK BR4-35/400	275991140	35	400	8.8	3.2	1.2	0.6	2 x 2.5 mm ² , AWG 14/19 L = 0.5 m
5	SK BR2-35/400-C	278282045	35	400	12	3.8	1.2	0.6	Terminals 2 x 10 mm ²
6	SK BR2-22/600-C	278282065	22	600	18	5.7	1.9	0.9	
7	SK BR2-12/1500-C	278282015	12	1500	45	14	4.8	2.2	
8	SK BR2-9/2200-C	278282122	9	2200	66	20	7.0	3.3	
9	SK BR4-400/100	275991210	400	100	2.2	0.8	0.3	0.15	2 x 1.9 mm ² , AWG 14/19 L = 0.5 m
10	SK BR4-220/200	275991220	220	200	4.4	1.6	0.6	0.3	
11	SK BR4-100/400	275991240	100	400	8.8	3.2	1.2	0.6	2 x 2.5 mm ² , AWG 14/19 L = 0.5 m
12	SK BR4-60/600	275991260	60	600	13	4.9	1.8	0.9	
13	SK BR2-100/400-C	278282040	100	400	12	3.8	1.2	0.6	Terminals 2 x 10 mm ²
14	SK BR2-60/600-C	278282060	60	600	18	5.7	1.9	0.9	
15	SK BR2-30/1500-C	278282150	30	1500	45	14	4.8	2.2	
16	SK BR2-22/2200-C	278282220	22	2200	66	20	7.0	3.3	
17	SK BR2-12/4000-C	278282400	12	4000	120	38	12	6.0	
18	SK BR2-8/6000-C	278282600	8	6000	180	57	19	9.0	
19	SK BR2-6/7500-C	278282750	6	7500	225	71	24	11	Terminals 2 x 25 mm ²
20	SK BR2-3/7500-C	278282753	3	7500	225	71	24	11	
21	SK BR2-3/17000-C	278282754	3	17000	510	161	54	25	

*) Maximum duration within 120s

Table 6: Electrical data for brake resistor SK BR2-... and SK BR4-...

The chassis brake resistors (SK BR2-...) listed above are equipped with a temperature switch at the factory. Two different temperature switches with different triggering temperatures are optionally available for bottom-mounted brake resistors (SK BR4-...)

In order to use the signal from the temperature switch it must be connected to a free digital input of the frequency inverter and, for example, parameterised with the function "Voltage block" or "Fast stop".

NOTICE
Impermissible heating

If the bottom-mounted resistor is mounted below the frequency inverter, a temperature switch with a rated switch-off temperature of 100°C (Part No. 275991200) must be used. This is necessary to prevent impermissible heating of the frequency inverter.

Failure to comply with this may result in damage to the cooling system of the device (fan).

Bi-metal temperature switch							
for SK...	Part No.	Protection class	Voltage	Current	Nominal switching temperature	Dimensions	Connecting cable/ terminals
BR4-...	275991100	IP40	250 Vac	2.5 A with $\cos\varphi=1$	180°C ± 5 K	Width +10 mm (one side)	2 x 0.8 mm ² , AWG 18 L = 0.5 m
BR4-...	275991200			1.6 A with $\cos\varphi=0.6$	100°C ± 5 K		
BR2-...	integrated	IP00	250 Vac 125 Vac 30 Vdc	10 A 15 A 5 A	180°C ± 5 K	Internal	terminals 2 x 4 mm ²

Table 7: Brake resistor temperature switch data

2.6.2 Dimensions of bottom-mounted BR SK BR4

Resistor type	Size	A	B	C	Fixing dimensions	
					D	Ø
SK BR4-240/100 SK BR4-150/100 SK BR4-400/100	Size 1	230	88	175	220	5.5
SK BR4- 75/200 SK BR4-220/200	Size 2	270	88	175	260	5.5
SK BR4-35/400 SK BR4-100/400	Size 3	285	98	239	275	5.5
SK BR4-60/600	Size 4	330	98	239	320	5.5

C = installation depth of the frequency inverter + bottom-mounted brake resistor all dimensions in mm

Table 8: Dimensions of bottom-mounted brake resistor SK BR4-...

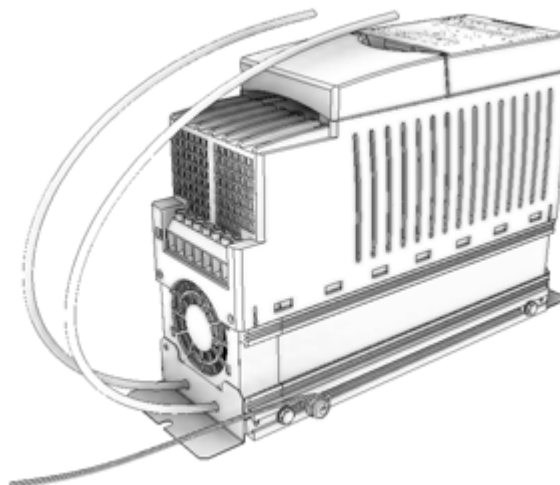

Example: SK 500E, BG2 and BR4-75-... with temperature switch (Part No. 275991200)

Fig. 5: Illustration of mounting the BR4- on the frequency inverter

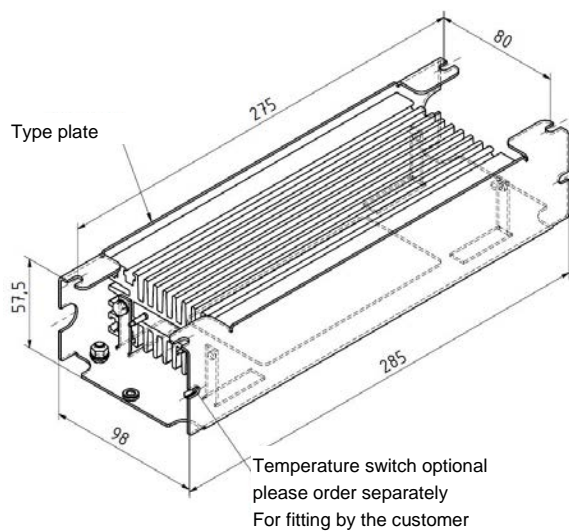
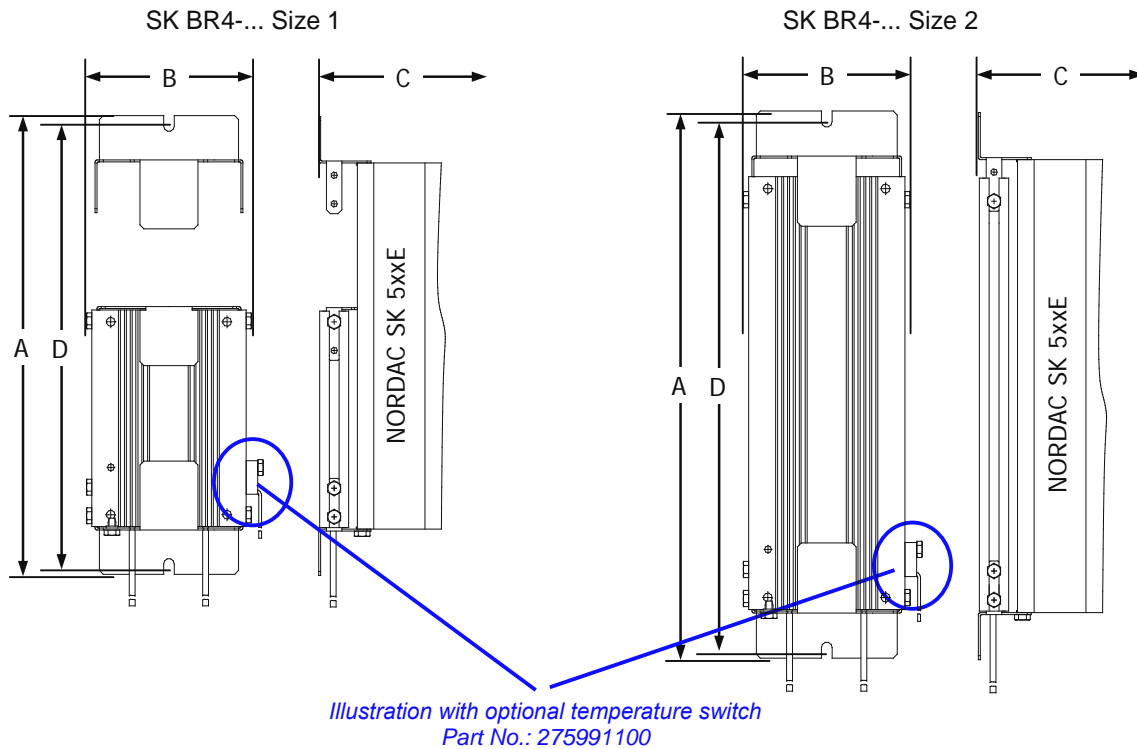

SK BR4... Size 3

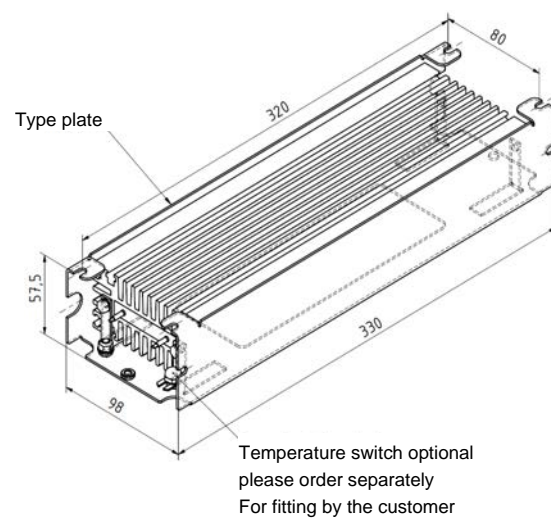

SK BR4... Size 4

Separate data sheets are available for bottom-mounted SK BR4 brake resistors above Size 3. These can be downloaded from www.nord.com.

Inverter type	Brake resistor type	Part No.	Data sheet
SK 5xxE-301-323- ... -401-323-	SK BR4-35/400	275991140	TI014 275991140
SK 5xxE-301-340- ... -401-340-	SK BR4-100/400	275991240	TI014 275991240
SK 5xxE-551-340- ... -751-340-	SK BR4-60/600	275991260	TI014 275991260

2.6.3 Dimensions of chassis BR SK BR2

Resistor type	A	B	C	Fixing dimensions			Weight
				D	E	Ø	
SK BR2-100/400-C	178	100	252	150	90	4.3	1.6
SK BR2- 35/400-C							
SK BR2- 60/600-C	385	92	120	330	64	6.5	1.7
SK BR2- 22/600-C							
SK BR2- 30/1500-C	585	185	120	526	150	6.5	5.1
SK BR2- 12/1500-C							
SK BR2- 22/2200-C	485	275	120	426	240	6.5	6.4
SK BR2- 9/2200-C							
SK BR2- 12/4000-C	585	266	210	526	240	6.5	12.2
SK BR2- 8/6000-C	395	490	260	370	380	10.5	13.0
SK BR2- 6/7500-C	595	490	260	570	380	10.5	22.0
SK BR2- 3/7500-C							
SK BR2- 3/17000-C	795	490	260	770	380	10.5	33.0
All dimensions in mm							[kg]

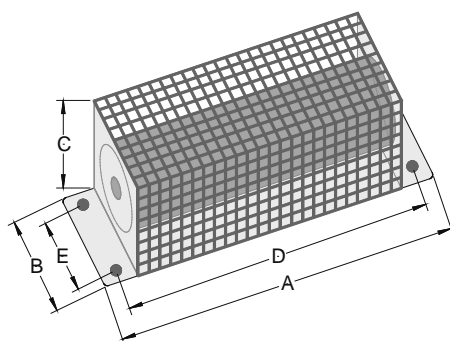

SK BR2-... FI size 3 and above
(Schematic diagram, model varies according to power)

Table 9: Dimensions of chassis brake resistor SK BR2-...

2.6.4 Brake resistor assignments

The brake resistor (BW) which is directly assigned to the frequency inverter according to the following table is dimensioned for approx. 10% of the rated power of the inverter. It is therefore suitable for brief brake operation or brake operation with a flat brake ramp, in which only a low total braking energy occurs.

Frequency inverter				BW ¹⁾
U [V]	P _{100%} [kW]	R _{min} [Ω]	SK 5xxE-	
115	0.25	240	250-112-	1 / -
	0.37	190	370-112-	1 / -
	0.55	140	550-112-	2 / -
	0.75	100	750-112-	2 / -
	1.1	75	111-112-	2 / -
230	0.25	240	250-323-	1 / -
	0.37	190	370-323-	1 / -
	0.55	140	550-323-	2 / -
	0.75	100	750-323-	2 / -
	1.1	75	111-323-	3 / -
	1.5	62	151-323-	3 / -
	2.2	46	221-323-	3 / -
	3.0	35	301-323-	4 / 5
	4.0	26	401-323-	4 / 5
	5.5	19	501-323-	6 / -
	7.5	14	751-323-	6 / -
	11.0	10	112-323-	7 / -
	15.0	7	152-323-	8 / -
	18.5	6	182-323-	8 / -

Frequency inverter				BW ¹⁾
U [V]	P _{100%} [kW]	R _{min} [Ω]	SK 5xxE-	
400	0.55	390	550-340-	9 / -
	0.75	300	750-340-	9 / -
	1.1	220	111-340-	10 / -
	1.5	180	151-340-	10 / -
	2.2	130	221-340-	10 / -
	3.0	91	301-340-	11 / 13
	4.0	74	401-340-	11 / 13
	5.5	60	501-340-	12 / 14
	7.5	44	751-340-	12 / 14
	11.0	29	112-340-	15 / -
	15.0	23	152-340-	15 / -
	18.5	18	182-340-	16 / -
	22.0	15	222-340-	16 / -
	30.0	9	302-340-	17 / -
	37.0	9	372-340-	17 / -
	45.0	8	452-340-	18 / -
	55.0	8	552-340-	18 / -
	75.0	6	752-340-	19 / -
	90.0	6	902-340-	19 / -
	110	3.2	113-340-	19 / -
	132	3	133-340-	20 / 21
	160	2.6	163-340-	21 / 20

1) Standard brake resistor according to Table (chapter 2.6.1), "Standard type / Alternative type (if available)"

Special brake resistors must be planned if higher brake powers occur (steeper braking ramps, longer braking processes (lifting equipment)). Alternatively, it may also be possible to implement the required braking power by the combination of standard brake resistors (please see chapter 2.6.5 "Combination of brake resistors").

2.6.5 Combination of brake resistors

By the combination of 2 or more standard brake resistors it is possible to implement considerably higher braking powers than are possible with the directly assigned standard brake resistor.

However, the following must be noted when doing this:

- **Series connection**

The powers and ohmic resistances are added. If the resulting ohmic resistance is too high, the braking power (e.g. a brief higher braking pulse) may not be able to be dissipated. As a result, the frequency inverter goes into an error state (Error E 5.0).

- **Parallel connection**

The powers and conduction values are added, the total resistance reduces. If the resulting ohmic resistance is too low, the current to the brake chopper will be too high. As a result, the frequency inverter goes into an error state (Error E 3.1). **In addition, the inverter may also be damaged.**

With the brake resistor combinations from the standard range which are listed below, at least 80% of the braking power in comparison with the rated power of the frequency inverter can be implemented. Taking into account the efficiency of the drive unit as a whole, these combinations can be used for almost all drive applications. It must be noted that in this case, the bottom-mounted brake resistors must be mounted close to the inverter.

Above an inverter power of > 55 kW or for greater required continuous powers or brief powers, a suitable brake resistor must be planned, as the necessary parameters can no longer be achieved with a sensible combination of brake resistors from the standard range.

Frequency inverter				Braking resistors		Resulting values			
U [V]	P _{100%} [kW]	R _{min} [Ω]	SK 5xxE-	Connection ¹⁾	Example ²⁾	R [Ω]	P [kW]	P _{peak} [kW] ³⁾	Pulse energy [kWs] ⁴⁾
115	0.25	240	250-112-	2 – 2	b	300	0.2	0.6	0.8
	0.37	190	370-112-	2 – 2 – 2	b	450	0.3	0.4	0.5
	0.55	140	550-112-	3 – 3 – 3	b	225	0.6	0.8	1.0
	0.75	100	750-112-	3 – 3 – 3	b	225	0.6	0.8	1.0
	1.1	75	111-112-	5 – 5 – 5	b	105	1.2	1.8	2.2
230	0.25	240	250-323-	2 – 2	b	300	0.2	0.6	0.8
	0.37	190	370-323-	2 – 2 – 2	b	450	0.3	0.4	0.5
	0.55	140	550-323-	3 – 3 – 3	b	225	0.6	0.8	1.0
	0.75	100	750-323-	3 – 3 – 3	b	225	0.6	0.8	1.0
	1.1	75	111-323-	5 – 5 – 5	b	105	1.2	1.8	2.2
	1.5	62	151-323-	5 – 5 – 5	b	105	1.2	1.8	2.2
	2.2	46	221-323-	6 – 6 – 6	b	66	1.8	2.9	3.5
	3.0	35	301-323-	(14 // 14) – (14 // 14)	a	60	2.4	3.2	3.8
	4.0	26	401-323-	(15 // 15) – (15 // 15)	a	30	6.0	6.4	6.0
	5.5	19	501-323-	(6 // 6) – (16 // 16)	a	22	5.6	8.8	7.5
	7.5	14	751-323-	17 – 17	b	24	8.0	8.0	7.5
	11.0	10	112-323-	18 – 18	b	16	12	12	14
	15.0	7	152-323-	19 – 19	b	12	15	16	19
18.5	6	182-323-	20 – 20	b	6	15	32	28	

Frequency inverter				Braking resistors		Resulting values			
U [V]	P _{100%} [kW]	R _{min} [Ω]	SK 5xxE-	Connection ¹⁾	Example ²⁾	R [Ω]	P [kW]	P _{peak} [kW] ³⁾	Pulse energy [kWs] ⁴⁾
400	0.55	390	550-340-	10 – 10 – 10	b	660	0.6	0.9	1.0
	0.75	300	750-340-	10 – 10 – 10	b	660	0.6	0.9	1.0
	1.1	220	111-340-	13 – 13 – 13	b	300	1.2	2.1	2.5
	1.5	180	151-340-	13 – 13 – 13	b	300	1.2	2.1	2.5
	2.2	130	221-340-	14 – 14 – 14	b	180	1.8	3.5	3.0
	3.0	91	301-340-	14 – 14 – 14 – 14	b	240	2.4	2.6	3.2
	4.0	74	401-340-	15 – 15 – 15	b	90	4.5	7.1	6.0
	5.5	60	501-340-	15 – 15 – 15	b	90	4.5	7.1	8.5
	7.5	44	751-340-	16 – 16 – 16	b	66	6.6	9.7	9.0
	11.0	29	112-340-	17 – 17 – 17	b	36	12	17	20
	15.0	23	152-340-	17 – 17 – 17	b	36	12	17	20
	18.5	18	182-340-	18 – 18 – 18	b	24	18	26	28
	22.0	15	222-340-	18 – 18 – 18	b	24	18	26	28
	30.0	9	302-340-	20 – 20 – 20 – 20	b	12	30	53	52
	37.0	9	372-340-	20 – 20 – 20 – 20	b	12	30	53	52
	45.0	8	452-340-	20 – 21 – 21	b	9	41	71	78
	55.0	8	552-340-	21 – 21 – 21	b	9	51	71	78

1) Type of connection of standard brake resistors from Table (chapter 2.6.1), Here: "/" = connected in parallel, "-" = connected in series

2) Connection example according to the following diagram

3) Maximum possible peak braking power with the stated resistor combination

4) Maximum possible pulse energy with 1% switch-on duration (1.2 sec once within 120 sec.) taking into account the absolute limit of the frequency inverter

Table 10: Combination of standard brake resistors

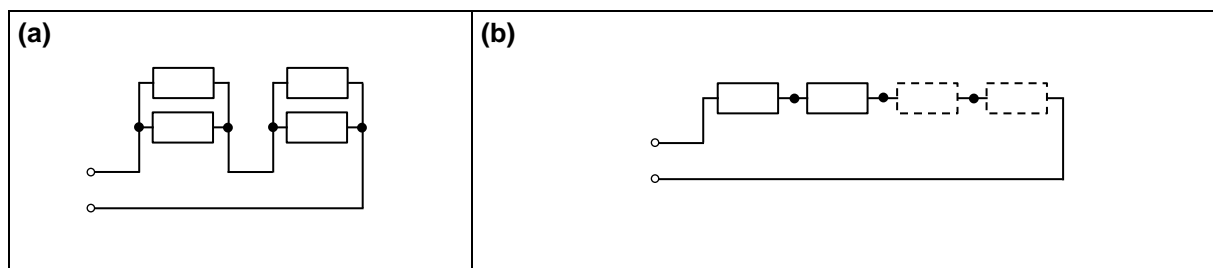

Fig. 6: Typical brake resistor connections

2.6.6 Monitoring of the brake resistor

To prevent overload of the brake resistor, it should be monitored during operation. The most reliable method is thermal monitoring with a temperature switch which is mounted directly on the brake resistor.

2.6.6.1 Monitoring with a temperature switch

Type SK BR2-... brake resistors are equipped with a suitable temperature switch as standard; suitable temperature switches are available as options for types SK BR4-... (please see chapter 2.6.1 "Electrical data for brake resistors"). If the bottom-mounted brake resistor is mounted below the frequency inverter (**SK BR4-...**) it must be noted that a temperature switch with a **reduced switching threshold (100°C)** must be used.

Typically, evaluation of the temperature switch is carried out by an external control system.

Alternatively, the temperature switch can be evaluated directly by the frequency inverter. To do this, it must be connected to a free digital input. This digital input must be parameterised with the function {10} "Block voltage".

Example, SK 520E

- Connect the temperature switch to digital input 4 (Terminal 42 / 24)
- Parameterise P423 to function {10} "Block voltage"

The switch opens if the maximum permissible temperature of the brake resistor is reached. The output of the frequency inverter is blocked. The motor runs down to a standstill.

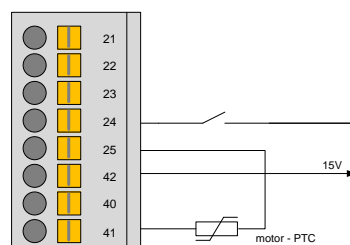

2.6.6.2 Monitoring with current measurement and calculation

As an alternative to monitoring with a temperature switch it is also possible to use an indirect, arithmetical monitoring of the the brake resistor load on the basis of measurement values.

This software-assisted indirect monitoring is activated by setting parameter (P556) "Brake resistor" and (P557) "Brake resistor power". The actual calculated brake resistor load can be read out in parameter (P737) "Brake resistor load". Overload of the brake resistor results in a shut-down of the frequency inverter with the error message E3.1 "Overcurrent Chopper I²t"

NOTICE

Overload of the brake resistor

The supported indirect monitoring using measurement of electrical data and calculation is based on standard ambient conditions. In addition, the calculated values are reset when the device is switched off. It is therefore not possible to detect the actual load on the brake resistor.

It is therefore possible that an overload may not be detected or its environment may be damaged due to excess temperatures.

Reliable temperature monitoring is only possible with the use of a temperature switch.

2.7 Chokes

Due to their operating principle, frequency inverters also generate effects on the motor side (e.g. harmonics, steep flanks, EMC interference) which may cause faults in the operation of the system or in the device itself. Input or link circuit chokes are primarily used for mains protection; in contrast, output chokes reduce effects caused by the motor.

2.7.1 Mains chokes

In principle, there are two types of chokes which are used to provide mains protection. Input chokes are connected into the supply cables directly upstream of the inverter; on the other hand, link circuit chokes are installed in the direct current link circuit of the frequency inverter. The functions of both chokes are comparable.

With the input choke / link circuit choke, the charging current from the mains and the harmonics are reduced.

For this, chokes fulfil several functions:

1. Reduction of the harmonics in the mains voltage upstream of the choke
2. Increase of efficiency due to lower input currents
3. Extension of the service life of the link circuit capacitors

The use of chokes is recommended if e.g. the component of the installed inverter power exceeds 20% of the transformer power. In addition, the use of chokes is advisable for very hard networks or capacitive compensation systems. Chokes also reduce the negative effects of asymmetrical mains voltages.

Above an inverter power of **45kW (Size 8)** use of a **link circuit choke** is always recommended.

If large voltage fluctuations occur in the supply network due to switching actions, e.g. frequent switching of large consumers connected in parallel, supply via power rails, or if other devices cause harmonics, the use of chokes is also recommended.

2.7.1.1 Link circuit choke SK DCL-

The link circuit choke is installed in the immediate vicinity of the frequency inverter and is connected directly to the direct current link circuit of the inverter. All chokes have a protection class corresponding to IP00. The choke used must therefore be installed in a control cabinet.

Inverter ID	Filter type	Part No.	Data sheet
SK 5xxE-452-340-A ... -552-340-A	SK DCL-950/120-C	276997120	TI 276997120
SK 5xxE-752-340-A ... -902-340-A	SK DCL-950/200-C	276997200	TI 276997200
SK 5xxE-113-340-A	SK DCL-950/260-C	276997260	TI 276997260
SK 5xxE-133-340-A	SK DCL-950/320-C	276997320	TI 276997320
SK 5xxE-163-340-A	SK DCL-950/380-C	276997380	TI 276997380

Table 11: Link circuit choke SK DCL-...

2.7.1.2 Input choke SK CI1-...

Type SK CI1- chokes are specified for a maximum supply voltage of 230 V or 480 V at 50/60 Hz.

All chokes have a protection class corresponding to IP00. The choke used must therefore be installed in a control cabinet.

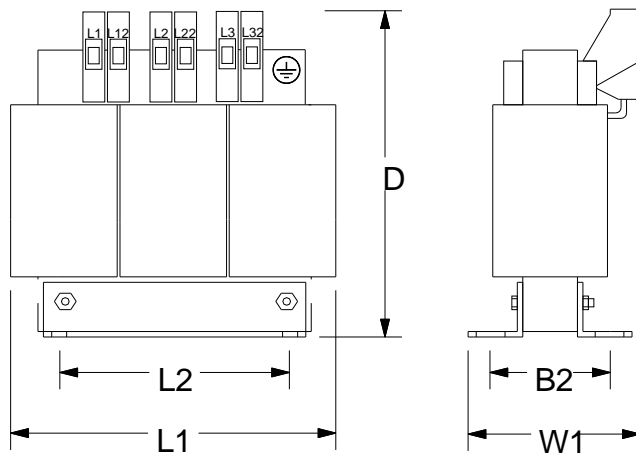

Similar to illustration

Inverter ID SK 500E	Input choke 1 x 220 - 240 V			L1	W1	D	Detail: Fastening			Connection	Weight
	Type	Continuous current [A]	Inductivity [mH]				L2	B2	Assembly		
0.25 ... 0.75 kW	SK CI1-230/8-C Part. No.: 278999030	8	2 x 1.0	78	65	89	56	40	M4	4	1.1
1.1 ... 2.2 kW	SK CI1-230/20-C Part. No.: 278999040	20	2 x 0.4	96	90	106	84	65	M6	10	2.2
All dimensions in [mm]										[mm ²]	[kg]

Table 12: Input choke data for SK CI1-..., 1~ 240 V

Inverter ID SK 500E	Input choke 3 x 200 - 240 V			L1	W1	D	Detail: Fastening			Connection	Weight
	Type	Continuous current [A]	Inductivity [mH]				L2	B2	Assembly		
0.25 ... 0.75 kW	SK CI1-480/6-C Part. No.: 276993006	6	3 x 4.88	96	60	117	71	45	M4	4	0.6
1.1 ... 1.5 kW	SK CI1-480/11-C Part. No.: 276993011	11	3 x 2.93	120	85	140	105	70	M4	4	2.1
2.2 ... 3.0 kW	SK CI1-480/20-C Part. No.: 276993020	20	3 x 1.47	155	110	177	135	95	M5	10	5.7
4.0 ... 7.5 kW	SK CI1-480/40-C Part. No.: 276993040	40	3 x 0.73	155	115	172	135	95	M5	10	7.5
11 ... 15 kW	SK CI1-480/70-C Part. No.: 276993070	70	3 x 0.47	185	122	220	170	77	M6	35	10.1
18.5 kW	SK CI1-480/100-C Part. No.: 276993100	100	3 x 0.29	240	148	263	180	122	M6	35	18.4
All dimensions in [mm]										[mm ²]	[kg]

Table 13: Input choke data for SK CI1-..., 3~ 240 V

Inverter ID SK 500E	Input choke 3 x 380 - 480 V			L1	W1	D	Detail: Fastening			Connection	Weight
	Type	Continuous current [A]	Inductivity [mH]				L2	B2	Assembly		
0.55 ... 2.2 kW	SK CI1-480/6-C Part. No.: 276993006	6	3 x 4.88	96	60	117	71	45	M4	4	0.6
3.0 ... 4.0 kW	SK CI1-480/11-C Part. No.: 276993011	11	3 x 2.93	120	85	140	105	70	M4	4	2.1
5.5 ... 7.5 kW	SK CI1-480/20-C Part. No.: 276993020	20	3 x 1.47	155	110	177	135	95	M5	10	5.7
11 ... 15 kW	SK CI1-480/40-C Part. No.: 276993040	40	3 x 0.73	155	115	172	135	95	M5	10	7.5
18.5 ... 30 kW	SK CI1-480/70-C Part. No.: 276993070	70	3 x 0.47	185	122	220	170	77	M6	35	10.1
37 ... 45 kW	SK CI1-480/100-C Part. No.: 276993100	100	3 x 0.29	240	148	263	180	122	M6	35	18.4
55 ... 75 kW	SK CI1-480/160-C Part. No.: 276993160	160	3 x 0.18	352	140	268	240	105	M8	M8*	27.0
90 kW	SK CI1-480/280-C Part. No.: 276993280	280	3 x 0.10	352	169	268	240	133	M10	M16*	40.5
110 ... 132 kW	SK CI1-480/350-C Part. No.: 276993350	350	3 x 0.08	352	169	268	328	118	M10	M16*	41.5
All dimensions in [mm]										[mm ²]	[kg]

* Bolt for copper rail, PE: M8

Table 14: Input choke data for SK CI1-..., 3~ 480 V

2.7.2 Output choke SK CO1

To reduce interference signals from the motor cable or to compensate for cable capacitance in long motor cables, an additional output choke (motor choke) can be installed into the inverter output.

During installation take care that the pulse frequency of the frequency inverter is set to 3 - 6 kHz (P504 = 3 - 6).

These chokes are specified for a maximum supply voltage of 480 V at 0 - 100 Hz.

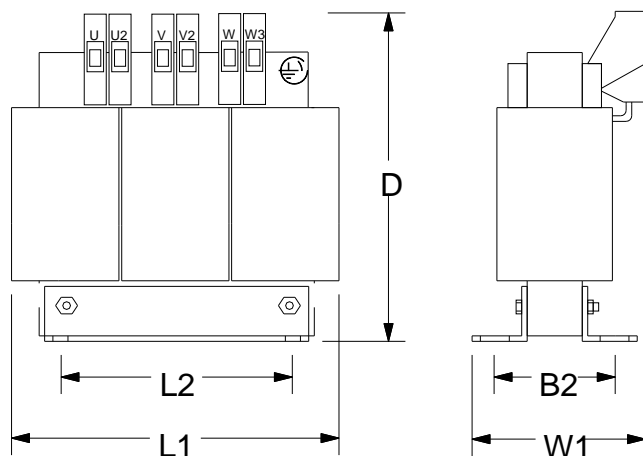

Similar to illustration

An output choke should be fitted for cable lengths over **100 m/30 m** (unshielded/shielded). All chokes have a protection class corresponding to **IP00**. The choke used must therefore be installed in a control cabinet.

Inverter ID SK 5xxE	Output choke 3 x200 – 240 V			L1	W1	D	Detail: Fastening			Connection	Weight
	Type	Continuous current [A]	Inductivity [mH]				L2	B2	Assembly		
0.25 ... 0.75 kW	SK CO1-460/4-C Part. No.: 276996004	4	3 x 3.5	120	104	140	84	75	M6	4	2.8
1.1 ... 1.5 kW	SK CO1-460/9-C Part. No.: 276996009	9	3 x 2.5	155	110	160	130	71.5	M6	4	5.0
2.2 ... 4.0 kW	SK CO1-460/17-C Part. No.: 276996017	17	3 x 1.2	185	102	201	170	57.5	M6	10	8.0
5.5 ... 7.5 kW	SK CO1-460/33-C Part. No.: 276996033	33	3 x 0.6	185	122	201	170	77.5	M6	10	10.0
11 ... 15 kW	SK CO1-480/60-C Part. No.: 276992060	60	3 x 0.33	185	112	210	170	67	M8	16	13.8
18.5 kW	SK CO1-460/90-C Part. No.: 276996090	90	3 x 0.22	352	144	325	224	94	M10	35	21.0
All dimensions in [mm]										[mm ²]	[kg]

Table 15: Output choke data for SK CO1-..., 3~ 240 V

Inverter ID SK 5xxE	Output choke 3 x 380 – 480 V			L1	W1	D	Detail: Fastening			Connection	Weight
	Type	Continuous current [A]	Inductivity [mH]				L2	B2	Assembly		
0.55 ... 1.5 kW	SK CO1-460/4-C Part. No.: 276996004	4	3 x 3.5	120	104	140	84	75	M6	4	2.8
2.2 ... 4.0 kW	SK CO1-460/9-C Part. No.: 276996009	9	3 x 2.5	155	110	160	130	71.5	M6	4	5.0
5.5 ... 7.5 kW	SK CO1-460/17-C Part. No.: 276996017	17	3 x 1.2	185	102	201	170	57.5	M6	10	8.0
11 ... 15 kW	SK CO1-460/33-C Part. No.: 276996033	33	3 x 0.6	185	122	201	170	77.5	M6	10	10.0
18.5 ... 30 kW	SK CO1-480/60-C Part. No.: 276992060	60	3 x 0.33	185	112	210	170	67	M8	16	13.8
37 ... 45 kW	SK CO1-460/90-C Part. No.: 276996090	90	3 x 0.22	352	144	325	224	94	M10	35	21.0
55 ... 75 kW	SK CO1-460/170-C Part. No.: 276996170	170	3 x 0.13	412	200	320	264	125	M10	M12*	47.0
90 ... 110 kW	SK CO1-460/240-C Part. No.: 276996240	240	3 x 0.07	412	225	320	388	145	M10	M12*	63.5
132 ... 160 kW	SK CO1-460/330-C Part. No.: 276996330	330	3 x 0.03	352	188	268	328	129	M10	M16*	52.5
All dimensions in [mm]										[mm ²]	[kg]

* Bolt for copper rail, PE M8

Table 16: Output choke data for SK CO1-..., 3~ 480 V

2.8 Line filter

An additional external line filter can be installed into the line supply of the frequency inverter to maintain the increased noise suppression level (class B as per EN 55011).

2.8.1 Mains filter SK NHD (up to size 4)

SK NHD type mains filters are so-called bottom-mounted combination filters with integrated mains choke. The mains filter is only intended for three-phase operation.

This provides a compact unit to improve the level of radio interference suppression, which can also be mounted underneath the frequency inverter if there is a shortage of space.

For further information about the mains filter, please refer to the relevant data sheet. These data sheets can be downloaded from www.nord.com.

Inverter ID	Filter type	Part No.	Data sheet
SK 5xxE-250-323-A ... -750-323-A	SK NHD-480/6-F	278273006	TI 278273006
SK 5xxE-111-323-A ... -221-323-A	SK NHD-480/10-F	278273010	TI 278273010
SK 5xxE-301-323-A ... -401-323-A	SK NHD-480/16-F	278273016	TI 278273016
SK 5xxE-550-340-A ... -750-340-A	SK NHD-480/3-F	278273003	TI 278273003
SK 5xxE-111-340-A ... -221-340-A	SK NHD-480/6-F	278273006	TI 278273006
SK 5xxE-301-340-A ... -401-340-A	SK NHD-480/10-F	278273010	TI 278273010
SK 5xxE-551-340-A ... -751-340-A	SK NHD-480/16-F	278273016	TI 278273016

Table 17: Mains filter NHD-...

2.8.2 Mains filter SK LF2 (size 5 - 7)

SK LF2 type mains filters are mains filters which can be bottom mounted, and their dimensions are matched to those of the relevant frequency inverter. This enables space-saving installation. These data sheets can be downloaded from www.nord.com.

Inverter ID	Filter type	Part No.	Data sheet
SK 5xxE-551-323-A ... -751-323-A	SK LF2-480/45-F	278273045	TI 278273045
SK 5xxE-112-323-A	SK LF2-480/66-F	278273066	TI 278273066
SK 5xxE-152-323-A ... -182-323-A	SK LF2-480/105-F	278273105	TI 278273105
SK 5xxE-112-340-A ... -152-340-A	SK LF2-480/45-F	278273045	TI 278273045
SK 5xxE-182-340-A ... -222-340-A	SK LF2-480/66-F	278273066	TI 278273066
SK 5xxE-302-340-A ... -372-340-A	SK LF2-480/105-F	278273105	TI 278273105

Table 18: Mains filter LF2-...

2.8.3 Line filter SK HLD

With a chassis-mounted mains filter, radio interference class **B** (Class C1) can be achieved up to a maximum motor cable length of 25 m.

When connecting the line filter, the "Wiring guidelines" Section (chapter 2.9.1) and "EMC" Section (chapter 8.3) must be complied with. In particular, care must be taken that the pulse frequency is set to the default value (P504 = 6kHz). The line filter should be placed as close to the side of the inverter as possible.

The connection is by means of screw connections on the upper (mains) and lower (inverter) ends of the filter

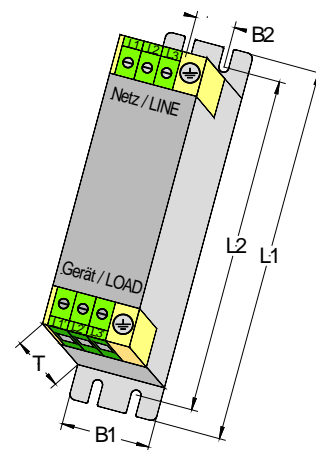

Inverter ID	Filter type [-V/A]	L1	W1	D	Detail: Fastening		Connection cross- section
					L2	B2	
SK 5xxE-250-323-A ... SK 5xxE-111-323-A	SK HLD 110-500/8	190	45	75	180	20	4
SK 5xxE-151-323-A ... SK 5xxE-221-323-A	SK HLD 110-500/16	250	45	75	240	20	4
SK 5xxE-301-323-A ... SK 5xxE-551-323-A	SK HLD 110-500/30	270	55	95	255	30	10
SK 5xxE-751-323-A	SK HLD 110-500/42	310	55	95	295	30	10
SK 5xxE-112-323-A	SK HLD 110-500/75	270	85	135	255	60	35
SK 5xxE-152-323-A... SK 5xxE-182-323-A	SK HLD 110-500/100	270	95	150	255	65	50
SK 5xxE-550-340-A... SK 5xxE-221-340-A	SK HLD 110-500/8	190	45	75	180	20	4
SK 5xxE-301-340-A ... SK 5xxE-551-340-A	SK HLD 110-500/16	250	45	75	240	20	4
SK 5xxE-751-340-A	SK HLD 110-500/30	270	55	95	255	30	10
SK 5xxE-112-340-A	SK HLD 110-500/42	310	55	95	295	30	10
SK 5xxE-152-340-A... SK 5xxE-182-340-A	SK HLD 110-500/55	250	85	95	235	60	16
SK 5xxE-222-340-A	SK HLD 110-500/75	270	85	135	255	60	35
SK 5xxE-302-340-A	SK HLD 110-500/100	270	95	150	255	65	50
SK 5xxE-372-340-A... SK 5xxE-452-340-A	SK HLD 110-500/130	270	95	150	255	65	50
SK 5xxE-552-340-A	SK HLD 110-500/180	380	130	181	365	102	95
SK 5xxE-752-340-A... SK 5xxE-902-340-A	SK HLD 110-500/250	450	155	220	435	125	150
SK 5xxE-113-340-A... SK 5xxE-163-340-A	In preparation						

All dimensions in mm mm²

Table 19: Mains filter HLD-...

Information

Use in UL-relevant area

If the frequency inverter is used in a UL-relevant area, the mains filter can be selected according to the FLA value which is assigned to the frequency inverter.

Example: SK 5xxE-302-340-A → Input current rms: 84 A / **FLA: 64.A → HLD 110-500/75**

2.9 Electrical connection

DANGER!

Danger due to electricity

THE DEVICES MUST BE EARTHED.

Safe operation of the devices requires that it is installed and commissioned by qualified personnel in compliance with the instructions provided in this Manual.

In particular, the general and regional installation and safety regulations for work on high voltage systems (e.g. VDE) must be complied with as must the regulations concerning correct use of tools and the use of personal protection equipment.

Dangerous voltages can be present at the mains input and the motor connection terminals even when the device is not in operation. Always use insulated screwdrivers on these terminal fields.

Ensure that the input voltage source is not live before setting up or changing an electrical connection to the unit.

Ensure that the device and the motor are specified for the correct supply voltage.

i Information

Temperature sensor and PTC (TF)

As with other signal cables, thermistor cables must be laid separately from the motor cables. Otherwise the interfering signals from the motor winding that are induced into the line affect the device.

Depending on the size of the frequency inverter, the connection terminals for the supply cables and the control cables are located in different positions. According to the configuration of the frequency inverter, various terminals are not present.

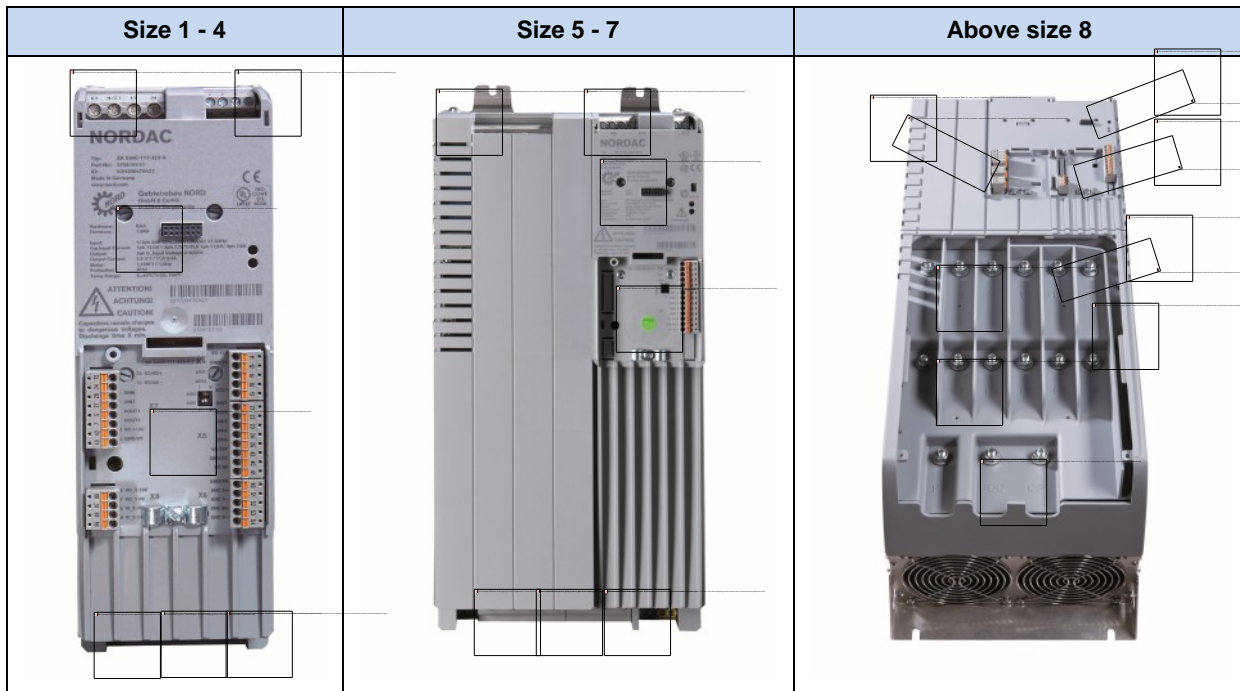

1 = Mains connection	L1, L2/N, L3, PE	X1	Above size 8:	X1.1, X1.2
2 = Motor connection	U, V, W, PE	X2	Above size 8:	X2.1, X2.2
3 = multi-function relay	1 - 4	X3		
4 = Braking resistor	+B, -B	X2	Above size 8:	X30
5 = DC - link circuit	-DC	X2	Above Size 8: + DC, - DC	X32
6 = Control terminals	IOs, GND, 24Vout, IG, DIP for AIR	→	X4, X5, X6, X7, X14	
7 = Technology unit				
8 = Link circuit choke			Above size 8: -DC, CP, PE	X31

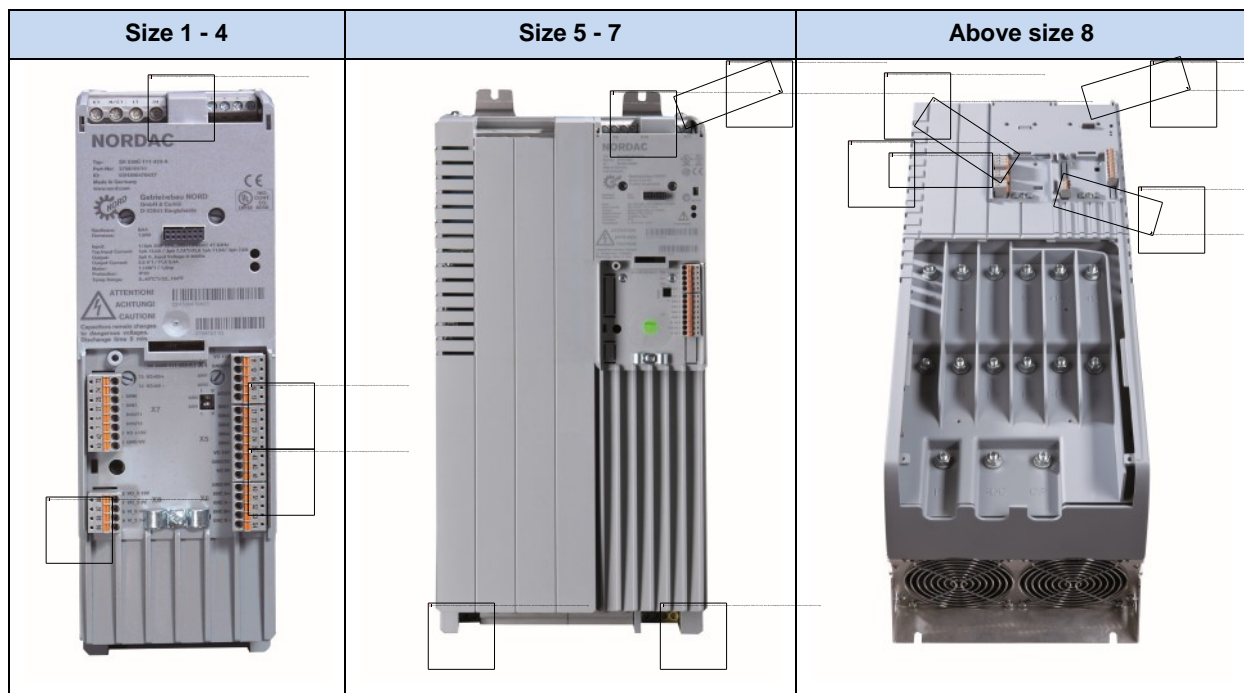

9 = communication	CAN/CANopen; RS232/RS485	→	X9/X10; X11
10 = Thermistor	T1/2 or TF+/-		X13 Up to size 4 (except SK 54xE): to DIN 5
11 = Safe pulse block	86, 87, 88, 89		X8
12 = Control voltage VI 24V	40, 44		X12 Except SK 5x0E and SK 511E

2.9.1 Wiring guidelines

The frequency inverters have been developed for use in an industrial environment. In this environment, high levels of electromagnetic interference can act on the frequency inverter. In general, correct installation ensures safe and problem-free operation. To meet the limiting values of the EMC directives, the following instructions should be complied with.

1. Ensure that all equipment in the control cabinet is securely earthed using short earthing cables which have large cross-sections and are connected to a common earthing point or earthing bar. It is especially important that each control unit which is connected to the electronic drive technology (e.g. an automatic device) has a short cable with a large cross-section, which is connected to the same earthing point as the frequency inverter itself. Flat cables (e.g. metal stirrups) are preferable, as they have a lower impedance at high frequencies.
2. The bonding cable of the motor controlled by the frequency inverter should be connected directly to the earthing terminal of the associated controller. The presence of a central earthing bar in the control cabinet and the grouping together of all bonding conductors to this bar normally ensures safe operation.
3. Where possible, shielded cables should be used for control circuits. The shielding at the cable end should be carefully sealed and it must be ensured that the wires are not laid over longer distances without shielding.

The shields of analog setpoint cables should only be earthed on one side on the device.

4. The control cables should be installed as far as possible from power cables, using separate cable ducts, etc. Where cables cross, an angle of 90° should be ensured as far as possible.
5. Ensure that the contactors in the cabinet are interference protected, either by RC circuits in the case of AC contactors or by free-wheeling diodes for DC contactors, for which **the interference traps must be positioned on the contactor coils**. Varistors for over-voltage limitation are also effective. This interference suppression is particularly important when the contactors are controlled by the relay in the frequency inverter.

6. Shielded or armoured cables should be used for the load connections (motor cable). The shielding or armouring must be earthed at both ends. If possible, earthing should be made directly to the electrically conducting mounting plate of the control cabinet or the screening angle of the EMC Kit.

In addition, EMC-compliant wiring must be ensured. If required, an optional output choke can be supplied

The safety regulations must be complied with under all circumstances when installing the frequency inverter!

NOTICE

Interference and damage

The control cables, mains cables and motor cables must be laid separately. Under no circumstances may they be installed in a common conduit or installation duct, in order to prevent interference.

The test equipment for high voltage insulations must not be used on cables that are connected to the motor controller. Failure to comply with this will cause damage to the drive electronics.

2.9.2 Adaptation to IT networks

As delivered, the inverter is configured for operation in TN or TT networks. For operation in IT networks, simple adaptations must be made. However, these impair the suppression of radio interference.

Up to and including Size 7, the adaptation is made with jumpers. As delivered, the jumpers are set in the "normal position". With this, the mains filter has its normal effect and leakage current. Above Size 8 a DIP switch element is provided. According to the position of the DIP switch, the frequency inverter is configured for TN/TT network operation or for IT network operation (also refer to Section 8.3 and 8.3.3)

Frequency inverter	Jumper A ¹⁾	Jumper B	Comments	Leakage current
Size 1 - 4	Position 1	Position 1	Operation in IT network	Not applicable
Size 1 - 4	Position 3	Position 2	Large filtering effect	< 30 mA
Size 1 - 4	Position 3	Position 3 ²⁾	Reduced filtering effect ²⁾	<< 30 mA > 3. mA
Size 5 - 7	Position 0	Position 1	Operation in IT network	Not applicable
Size 5 - 7	Position 4	Position 2	Large filtering effect	< 6 mA
	DIP-Switch "EMC Filter"			
Size 8 - 11	OFF		Operation in IT network	< 30 mA
Size 8 - 11	ON		Large filtering effect	< 10 mA
<small>1) Jumper "A" is only for type SK 5xxE-...-A inverters 2) Only valid for type SK 5xxE-...-A inverters. For type SK 5xxE-...-O inverters, this jumper position is similar to position 1</small>				

Table 20: Adaptation of integrated mains filter

NOTICE

Operation in IT networks

The use of this frequency inverter on an **IT network** is possible after modification of the integrated mains filter.

It is urgently recommended that the frequency inverter is only operated on a IT network if a braking resistor is connected. If an earthing fault occurs in the IT network, this measure prevents an impermissible charging of the link circuit capacitor and the associated destruction of the frequency inverter.

For operation with an insulation monitor, the insulation resistance of the frequency inverter must be taken into account.

Adaptation for Size 1 – 7

NOTICE

Jumper positions

Jumper positions which are not illustrated below must not be used, as these may cause the destruction of the frequency inverter.

Jumper 'A' network input (only type SK 5xxE-...-A inverters)

Size 1 – 4



Operation in IT network = Position 1
(reduced leakage current)



Normal position = Position 3

Top side of device



Size 5 – 7



Operation in IT network = Position 0
(reduced leakage current)



Normal position = Position 4

Top side of device



Jumper 'B' motor output

Size 1 – 4



Operation in IT network = Position 1
(reduced leakage current)



Normal position = Position 2



Reduced leakage current – Position 3
(The set pulse frequency (P504) only has a slight influence on the leakage current.)
(for type **SK 5xxE-...-O** inverters the function is identical to position 1))

Underside of the device

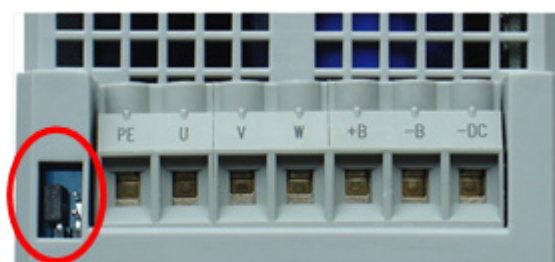

Size 5 – 7



Operation in IT network = Position 1
(reduced leakage current)



Normal position = Position 2

Underside of the device



Adaptation above size 8:

Adaptation to an IT network is carried out via the DIP switch "EMC filter" (1). As delivered, this switch is in the "ON" position.

For operation in an IT network the switch must be set to the "OFF" position. The leakage current is reduced, with impairment of EMC compatibility.

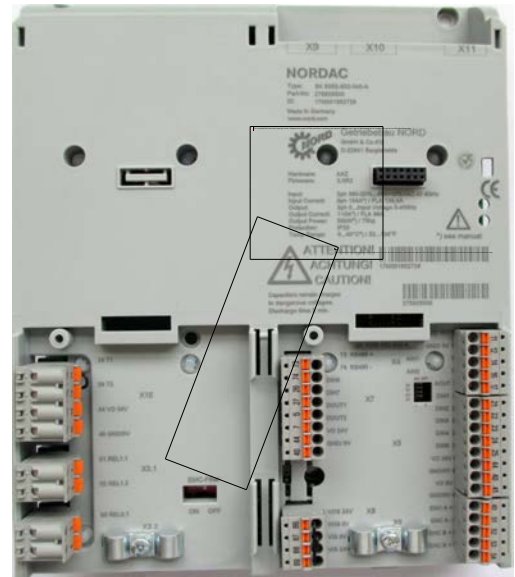

2.9.3 DC-coupling

NOTICE

Overload of link circuits

It is essential to note the following summary of criteria for the setup of a DC supply or the coupling of the link circuits of frequency inverters.

Errors in the link circuit coupling have especially negative effects on the charging circuits in the inverters or on the life span of the link circuits - including their complete destruction.

In drive engineering, DC-coupling is advisable if motors act as drivers and generators at the same time in the system. Here, the energy from the drive which is acting as a generator can be fed back to the drive which is acting as a motor. The advantages are lower energy consumption and the sparing use of braking resistors. In addition, the energy balance can be made even more efficient with the use of a regenerative feedback unit or an input/feedback unit. *In general, in case of DC coupling, wherever possible, devices with the same power should be connected together. Furthermore, only operational devices (whose link circuits are charged) must be coupled.*

Connection

Size 1 ... 7	+B, - DC
Above size 8:	+ DC, - DC

NOTICE

DC coupling for single phase devices

For direct current coupling of single-phase devices, care must be taken that the coupling to the same external conductor is used. Otherwise the device may be destroyed.

For the 115V devices (SK 5xx-xxx-112-O), no DC coupling is possible.

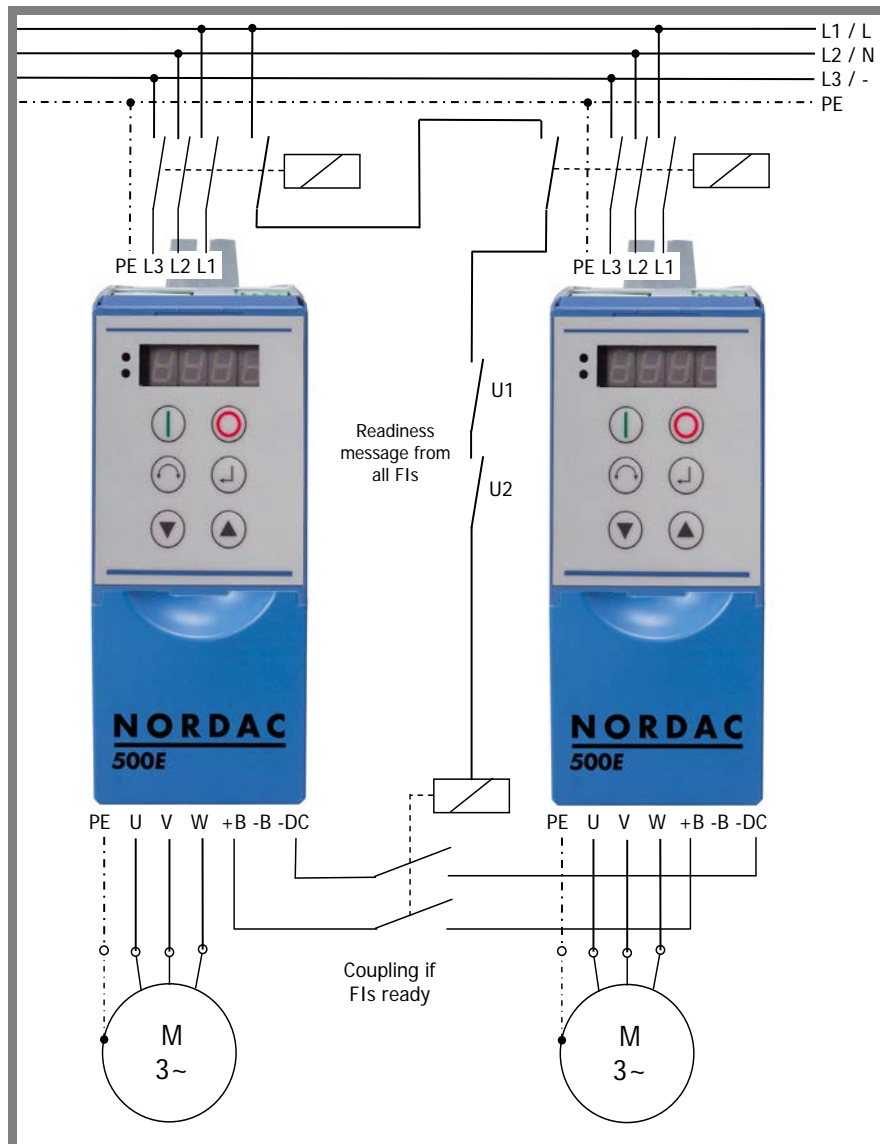

Fig. 7 Diagram of a DC-coupling

- 1 The link circuits of the individual frequency inverters must be protected with suitable fuses.
- 2 The frequency inverters only obtain their power supply via the link circuit. Electrical isolation is carried out via the power circuit breakers which must be provided in the supplies to the devices.
- 3 **CAUTION!** Ensure that the coupling is only made after readiness is reported. Otherwise, there is a danger that all the frequency inverters will be charged by a single one.
- 4 Ensure that the coupling is disconnected as soon as one of the devices is no longer ready for operation.
- 5 For a high availability a braking resistor must be used. If different sizes of frequency inverters are used, the braking resistor must be connected to the larger of the two frequency inverters.
- 6 If devices with the same rating (identical type) are coupled, and the same mains impedances are in effect (identical lengths of cable to the mains rail), the frequency inverters may be operated without mains chokes. Otherwise a mains choke must be installed in the mains cable of each frequency inverter.

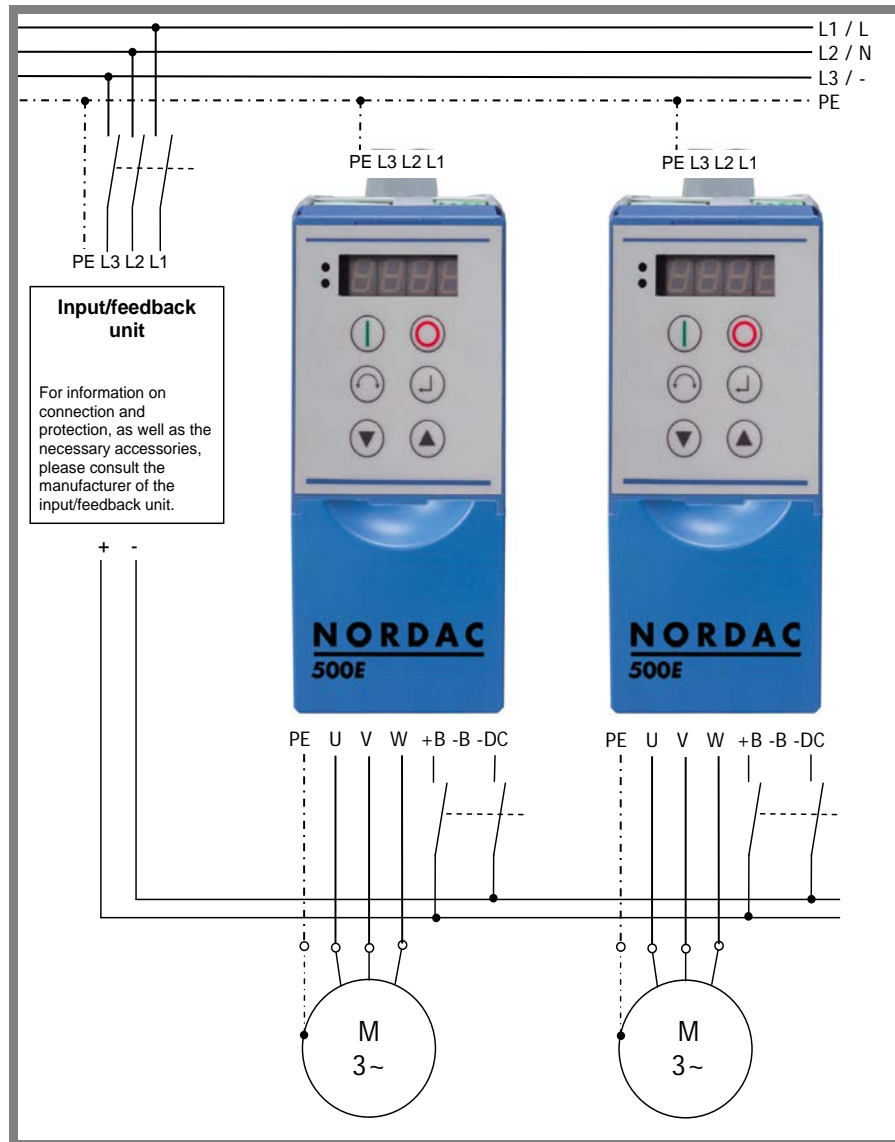

Fig. 8 Diagram of a DC coupling with an input/feedback unit

The following points must be taken into consideration in association with a DC supply:

- 1 Use a connecting cable which is as short as possible between the DC bus and the equipment to be connected. The connection and protection of the devices in the DC circuit must be carried out for cable protection and the maximum cross-section of the device.
- 2 The link circuits of the individual frequency inverters must be protected with suitable fuses.
- 3 The frequency inverters only obtain their supply via the link circuit. Electrical isolation is carried out via the power circuit breakers which must be provided in the supplies to the devices.
- 4 For frequency inverters above size 8, a DC supply is only permissible with an external charging device.
- 5 Set the value **P538** = 4 „dc-supply“.

2.9.4 Electrical connection of power unit

The following information relates to all power connections to the frequency inverter. This includes:

- Mains cable connection (L1, L2/N, L3, PE)
- Motor cable connection (U, V, W, PE)
- Brake resistor connection (B+, B-)
- Link circuit connection (-DC, (+DC))
- Link circuit choke connection (-DC, CP, PE)

Before connecting the frequency inverter, the following must be observed:

1. Ensure that the mains supply provides the correct voltage and is suitable for the current required.
2. Ensure that suitable circuit breakers with the specified nominal current range are installed between the voltage source and the inverter.
3. Connect the mains voltage directly to the mains terminals L1-L2/N-L3-PE (for each device)
4. A four-core cable must be used to connect the motor. The cable is connected to the motor terminals PE-U-V-W.
5. If screened motor cables (recommended) are used, the cable screening must also be connected to a large area of the metallic screening angle of the EMC Kit, however, at least to the electrically conducting mounting surface of the control cabinet.
6. Above size 8, the cable lugs which are included in the scope of delivery must be used. After crimping, these must be insulated with shrink hose.

Information

The use of shielded cables is essential in order to maintain the specified radio interference suppression level.

If certain wire end sleeves are used, the maximum cross-section which can be connected can be reduced.

To connect the power unit, the following **tools** must be used:

Frequency inverter	Tools	Type
Size 1 - 4	Screwdriver	SL / PZ1; SL / PH1
Size 5 - 7	Screwdriver	SL / PZ2; SL / PH2
Size 8 - 11	Socket wrench	SW 13

Table 21: Tools

Connection data:

Frequency inverter	Cable Ø [mm²]		AWG	Tightening torque	
	rigid	flexible		[Nm]	[lb-in]
1 ... 4	0.2 ... 6	0.2 ... 4	24-10	0.5 ... 0.6	4.42 ... 5.31
5	0.5 ... 16	0.5 ... 10	20-6	1.2 ... 1.5	10.62 ... 13.27
6	0.5 ... 35	0.5 ... 25	20-2	2.5 ... 4.5	22.12 ... 39.82
7	0.5 ... 50	0.5 ... 35	20-1	2.5 ... 4	22.12 ... 35.4
8	50	50	1/0	15	135
9	95	95	3/0	15	135
10	120	120	4/0	15	135
11	150	150	5/0	15	135

Table 22: Connection data

NOTICE

Brake voltage supply

The voltage supply for an electro-mechanical brake (or its brake rectifier) must be via the mains.

Connection to the output side (connection to the motor terminals) may cause the destruction of the brake or the frequency inverter.

Mains connections (X1 – PE, L1, L2/N, L3)

No special safety measures are required on the mains input side of the frequency inverter. It is advisable to use the normal mains fuses (see technical data) and a main switch or circuit breaker.

Frequency inverter data		Permissible mains data			
Voltage	Power	1 ~ 115 V	1 ~ 230 V	3 ~ 230 V	3 ~ 400 V
115 VAC	0.25 ... 0.75 kW	X			
230 VAC	0.25 ... 2.2 kW		X	X	
230 VAC	≥ 3.0 kW			X	
400 VAC	≥ 0.37 kW				X
Connections		L/N = L1/L2	L/N = L1/L2	L1/L2/L3	L1/L2/L3

Isolation from or connection to the mains must always be carried out for all the poles and synchronously (L1/L2/L3 or L1/N).

NOTICE

Operation in IT networks

The use of this frequency inverter on an **IT network** is possible after modification of the integrated mains filter.

It is urgently recommended that the frequency inverter is only operated on a IT network if a braking resistor is connected. If an earthing fault occurs in the IT network, this measure prevents an impermissible charging of the link circuit capacitor and the associated destruction of the frequency inverter.

For operation with an insulation monitor, the insulation resistance of the frequency inverter must be taken into account.

Motor cable (X2 - U, V, W, PE)

The motor cable may have a **total length of 100m** if this is a standard cable (take EMC into consideration). If a screened motor cable is used, or if the cable is laid in a metal conduit which is well earthed, the **total length should not exceed 30m**.

For greater lengths of cable, an additional output choke (accessory) must be used.

For multiple motor operation the total motor cable length consists of the sum of the individual cable lengths.

NOTICE

Output switching

The motor cable must not be switched as long as the inverter is pulsing (The inverter must be in "Standby" or "Starting disabled" status).

Otherwise the inverter may be damaged.

Brake resistor (X2 - +B, -B)

The terminals +B/ -B are intended for the connection of a suitable braking resistor. A short screened connection should be selected. For the installation of a braking resistor, the large amount of heat which is generated due to its operation (> 70°C) must be taken into account.

2.9.5 Electrical connection of the control unit

The control connections are located under the front cover (above size 8 under the two front covers) of the frequency inverter. The configuration differs according to the size. Up to size 7, the individual control terminals (X3, X8, X13) are in staggered positions (please see chapter 2.9 "Electrical connection").

Connection data:

Frequency inverter	All	Size 1 ... 4	Size 5 ... 7	Above size 8:
Terminal block	Typically	X3	X3, X8, X12, X13	X3.1/2, X15
Rigid cable Ø [mm²]	0.14 ... 1.5	0.14 ... 2.5	0.2 ... 6	0.2 ... 2.5
Flexible cable Ø [mm²]	0.14 ... 1.5	0.14 ... 1.5	0.2 ... 4	0.2 ... 2.5
AWG standard	26-16	26-14	24-10	24-12
Starting torque [Nm] [lb-in]	Clamping	0.5 ... 0.6	0.5 ... 0.6	Clamping
		4.42 ... 5.31	4.42 ... 5.31	

GND/0V is a common reference potential for analog and digital inputs.

Furthermore, it must be taken into account that with **SK 5x5E** size 1 ... 4 frequency inverters, terminal 44 is used to feed in the control voltage. However with devices of size 5 and above, this terminal provides a 24V control voltage.

Information

Total currents

5 V / 15 V (24 V) can be obtained from several terminals if required. This also includes e.g. digital outputs or a operating module connected via RJ45

With size 1 ... 4, the total output current must not exceed 250 mA / 150 mA (5 V / 15 V). Above Size 5 the limiting value is 250 mA / 200 mA (5 V/24 V).

NOTICE

Cable laying

All control cables (including thermistors) must be routed separately from the mains and the motor cables to prevent interference in the device.

If the cables are routed in parallel, a minimum distance of 20 cm must be maintained from cables which carry a voltage of > 60 V. The minimum distance may be reduced by screening the cables which carry a voltage, or by the use of earthed metal partitions within the cable conduits.

Terminal block X3, (above size 8: X3.1 and X3.2) - Relay

Relevance	SK 500E	SK 505E	SK 510E	SK 511E	SK 515E	SK 520E	SK 530E	SK 535E
	√	√	√	√	√	√	√	√
Terminals X3:	1	2	3	4				
Name	K1.1	K1.2	K2.1	K2.2				

Terminal	Function [Factory setting]	Data	Description / wiring suggestion	Parameter
1	Output 1 [Braking control]	Relay closing contact	Brake control (closes on enabling)	P434
2		230 VAC, 24 VDC,		
3	Output 2 [Ready/Fault]	< 60 VAC in circuits with safe isolation,	Fault / Ready (closes when FI ready / no fault)	P441
4		≤ 2 A		

Terminal block X4 – Analog I/O

Relevance	SK 500E	SK 505E	SK 510E	SK 511E	SK 515E	SK 520E	SK 530E	SK 535E
	√	√	√	√	√	√	√	√
Terminals X4:	11	12	14	16	17			
Name	VO 10V	GND/0V	AIN1	AIN2	AOUT1			

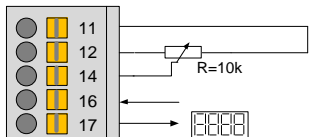
Terminal	Function [factory setting]	Data	Description / wiring suggestion	Parameter
11	10V Reference voltage	10V, 5mA, Not short circuit resistant	The analog input controls the output frequency of the frequency inverter.	
12	Reference potential for analog signals	0V analog		
14	Analog input 1 [set point frequency]	V=0...10V, R _i =30kΩ, I=0/4...20mA, R _i =250Ω, can be switched over with DIP switch, reference voltage GND.	 <p>The possible digital functions are described in Parameter P420.</p> <p><u>Above Size 5:</u> Configuration of analog input with DIP switch (see below)</p>	P400
16	Analog input 2 [no function]	For the use of digital functions 7.5...30V. <u>Above Size 5:</u> also -10 ... + 10 V signals		
17	Analog output [no function]	0...10V Reference potential GND Max. load current: 5mA analog, 20mA digital	Can be used for an external display or for further processing in a following machine.	P418

Analog signal configuration

Size 1 ... 4

1 = DIP switch: left = I / right = V

AIN2:	I	= Current 0/4 ... 20 mA
	V	= Voltage
AIN1:	I	= Current 0/4 ... 20 mA
	V	= Voltage

Above Size 5:

1 = DIP switch: left = ON / right = OFF

S4:	AIN2:	ON	= ± 10 V
		OFF	= 0 ... 10 V
S3:	AIN1:	ON	= ± 10 V
		OFF	= 0 ... 10 V
S2:	AIN2:	I	= ON = current 0/4...20 mA
		V	= OFF = voltage
S1:	AIN1:	I	= ON = current 0/4...20 mA
		V	= OFF = voltage

Note:

If S2 = ON (AIN2 = Current input), S4 must be = OFF.

If S1 = ON (AIN1 = Current input), S3 must be = OFF.

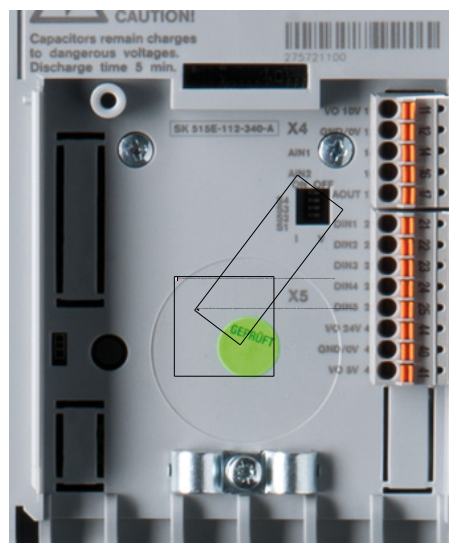

Terminal block X5 – Digital In

Relevance	SK 500E	SK 505E	SK 510E	SK 511E	SK 515E	SK 520E	SK 530E	SK 535E
	√		√	√		√	√	
Terminals X5:	21	22	23	24	25	42	40	41
Designation	DIN1	DIN2	DIN3	DIN4	DIN5	VO 15V	GND/0V	VO 5V

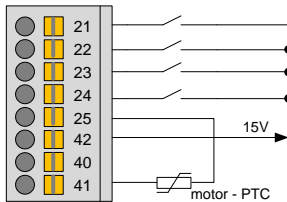
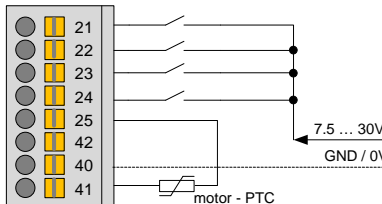
Terminal	Function [factory setting]	Data	Description / wiring suggestion	Parameter
21	Digital input 1 [ON right]	7.5...30V, $R_i=6.1k\Omega$ Not suitable for thermistor evaluation. HTL encoders can only be connected to DIN2 and DIN4 Limiting frequency: max. 10 kHz	Each digital input has a reaction time of $\leq 5ms$. Connection with internal 15V: 	P420
22	Digital input 2 [ON left]			P421
23	Digital input 3 [parameter set bit0]			P422
24	Digital input 4 [Fixed frequency 1, P429]			P423
25	Digital input 5 [no function]	2.5...30V, $R_i=2.2k\Omega$ Not suitable for evaluation of a safety device. Suitable for thermistor evaluation with 5V. NOTE: For the motor thermistor P424 = 13 must be set.	Connection with external 7.5-30V: 	P424
42	15V supply voltage output	15V \pm 20% max. 150 mA (output)	Supply voltage provided by the frequency inverter for connection to the digital inputs or the supply of a 10-30V encoder.	
40	Reference potential for digital signals	0V digital	Reference potential	
41	5V supply voltage output	5V \pm 20% max. 250 mA (output) short-circuit resistant	Voltage supply for motor-PTC	

Relevance	SK 500E	SK 505E	SK 510E	SK 511E	SK 515E	SK 520E	SK 530E	SK 535E	
		√			√			√	
Terminals X5:	21	22	23	24	25	44*	40	41	* Terminal 44: up to Size 4: VI Size 5 and above: VO
Designation	DIN1	DIN2	DIN3	DIN4	DIN5	V...24V	GND/0V	VO 5V	

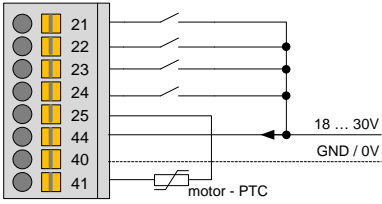
Terminal	Function [factory setting]	Data	Description / wiring suggestion	Parameter
21	Digital input 1 [ON right]	7.5...30V, R _i =6.1kΩ Not suitable for thermistor evaluation. HTL encoders can only be connected to DIN2 and DIN4 Limiting frequency: max. 10 kHz	Each digital input has a reaction time of ≤ 5ms. 	P420
22	Digital input 2 [ON left]			P421
23	Digital input 3 [parameter set bit0]			P422
24	Digital input 4 [Fixed frequency 1, P429]			P423
25	Digital input 5 [no function]	<u>Only S1 – S4</u> 2.5...30V, R _i =2.2kΩ Not suitable for evaluation of a safety device. Suitable for thermistor evaluation with 5V. NOTE: For the motor thermistor P424 = 13 must be set. <u>Size 5 and above</u> Thermistor on X13:T1/T2		P424
44	<u>Size 1 to Size 4</u> VI 24V supply voltage input	18...30V min. 800 mA (input)	Voltage supply for the FI control unit. Is essential for the function of the frequency inverter.	
	<u>Size 5 and above</u> VO 24V supply voltage output	24V ± 25% max. 200 mA (output) short circuit resistant	Supply voltage provided by the frequency inverter for connection to the digital inputs or the supply of a 10-30V encoder. The 24V control voltage is generated by the FI, however it can also be supplied via the terminals X12:44/40 (Size 8 and above: X15:44/40). Supply via terminal X5:44 is not possible.	
40	Reference potential for digital signals	0V digital	Reference potential	
41	5V supply voltage output	5V ± 20% max. 250 mA (output) short-circuit resistant	Voltage supply for motor-PTC	

Terminal block X6 – Encoder

Relevance	SK 500E	SK 505E	SK 510E	SK 511E	SK 515E	SK 520E	SK 530E	SK 535E	
						√	√	√	
Terminals X6:	40	51	52	53	54				
Name	GND/0V	ENC A+	ENC A-	ENC B+	ENC B-				

Terminal	Function [factory setting]	Data	Description / wiring suggestion	Parameter
40	Reference potential for digital signals	0V digital	<p>The incremental encoder input can be used for the exact regulation of the speed of rotation, additional set point functions or positioning (SK530E and above).</p> <p>An encoder system with 10-30V supply voltage must be used in order to compensate for voltage drop in long cable connections.</p> <p>Note: Encoders with 5V supply are not suitable in order to set up a system which operates reliably.</p>	P300
51	Track A	TTL, RS422 500...8192Imp./Rpm. Limiting frequencies: max. 205 kHz		
52	Track A inverse			
53	Track B			
54	Track B inverse			

Terminal block X7 – Digital I/O

Relevance	SK 500E	SK 505E	SK 510E	SK 511E	SK 515E	SK 520E	SK 530E	SK 535E	
						√	√		
Terminals X7:	73	74	26	27	5	7	42	40	
Designation	RS485 +	RS485 -	DIN6	DIN7	DOUT1	DOUT2	VO 15V	GND/0V	

Terminal	Function [factory setting]	Data	Description / wiring suggestion	Parameter
73	Data cable RS485	Baud rate 9600...38400Baud Termination resistor R=120Ω	BUS connection parallel to RS485 on RJ12 plug NOTE: The termination resistance of DIP switch 1 (see RJ12/RJ45) can also be used for terminal 73/74.	P503 P509
74				
26	Digital input 6 [no function]	7.5...30V, R _i =3.3kΩ	As described for terminal block X5, DIN1 to DIN5. Not suitable for the evaluation of a motor thermistor.	P425 P470
27	Digital input 7 [no function]			
5	Output 3 (DOUT1) [no function]	Digital output 15V, max. 20 mA With inductive loads: provide protection via free-wheeling diode.	For evaluation in a control system. The scope of functions corresponds to that of the relay (P434).	P450 P455
7	Output 4 (DOUT2) [no function]			
42	15V supply voltage output	15V ± 20% max. 150 mA (output) short-circuit resistant	Voltage supply for connection to the digital inputs or the supply of a 10-30V encoder	
40	Reference potential for digital signals	0V digital		

Relevance	SK 500E SK 505E SK 510E SK 511E SK 515E SK 520E SK 530E SK 535E								
Terminals X7:	73	74	26	27	5	7	44*	40	* Terminal 44: up to Size 4: VI Size 5 and above: VO
Designation	RS485 +	RS485 -	DIN6	DIN7	DOUT1	DOUT2	V...24V	GND/0V	

Terminal	Function [factory setting]	Data	Description / wiring suggestion	Parameter
73	Data cable RS485	Baud rate 9600...38400Baud Termination resistor R=120Ω	BUS connection parallel to RS485 on RJ12 plug NOTE: The termination resistance of DIP switch 1 (see RJ12/RJ45) can also be used for terminal 73/74.	P503 P509
74				
26	Digital input 6 [no function]	7.5...30V, R _i =3.3kΩ	As described for terminal block X5, DIN1 to DIN5. Not suitable for the evaluation of a motor thermistor.	P425
27	Digital input 7 [no function]			P470
5	Output 3 (DOUT1) [no function]	Digital output <u>S1 to S4</u>	For evaluation in a control system. The scope of functions corresponds to that of the relay (P434).	P450
7	Output 4 (DOUT2) [no function]	18-30V, according to VI 24V, max. 20 mA <u>above Size 5</u> DOUT1 and DOUT2: 24V, max. 200 mA With inductive loads: provide protection via free- wheeling diode.		P455
44	<u>Size 1 to Size 4</u> VI 24V supply voltage input	18...30V min. 800 mA (input)	Voltage supply for the FI control unit. Is essential for the function of the frequency inverter.	
	<u>Size 5 and above</u> VO 24V supply voltage output	24V ± 25% max. 200 mA (output) short circuit resistant	Supply voltage provided by the frequency inverter for connection to the digital inputs or the supply of a 10-30V encoder. The 24V control voltage is generated by the FI, however it can also be supplied via the terminals X12:44/40. Supply via terminal X7:44 is not possible.	
40	Reference potential for digital signals	0V digital		

Terminal block X8 – Safe pulse lock (not with 115V devices)

Relevance	SK 500E	SK 505E	SK 510E	SK 511E	SK 515E	SK 520E	SK 530E	SK 535E
			√	√			√	
Terminal X8:	86	87	88	89				
Designation	VO_S 15V	VO_S 0V	VI_S 0V	VI_S 24V				

Terminal	Function [factory setting]	Data	Description / wiring suggestion	Parameter
86	Supply voltage	Not short circuit resistant, Details: BU0530!	When setting-up without using a safety function, wire directly to V_IS 24V.	P420 et seq.
87	Reference potential			
88	Reference potential	Details: BU0530!	Fail-safe input	
89	Input 'Safe Pulse Block'			

Relevance	SK 500E	SK 505E	SK 510E	SK 511E	SK 515E	SK 520E	SK 530E	SK 535E
					√			√
Terminal X8:	86	87	88	89				
Designation	VO_S 24V	VO_S 0V	VI_S 0V	VI_S 24V				

Terminal	Function [factory setting]	Data	Description / wiring suggestion	Parameter
86	Supply voltage	Not short circuit resistant Details: BU0530!	When setting up without using a safety function, wire directly to V_IS 24V.	P420 et seq.
87	Reference potential			
88	Reference potential	Details: BU0530!	Fail-safe input	
89	Input 'Safe Pulse Block'			

Control block X9 and X10 – CAN / CANopen

Relevance	SK 500E	SK 505E	SK 510E	SK 511E	SK 515E	SK 520E	SK 530E	SK 535E
				√	√	√	√	√
Terminals X9: / X10:	1	2	3	4	5	6	7	8
Name	CAN_H	CAN_L	CAN_GND	nc	nc	CAN_SHD	CAN_GND	CAN_24V

Contact	Function [factory setting]	Data	Description / wiring suggestion	Parameter
1	CAN/CANopen signal	Baud rate ...500 kBaud RJ45 sockets are connected in parallel internally. Terminal resistance R=240 Ω DIP 2 (see below) NOTE: To operate CANbus/CANopen the interface must be externally supplied with 24 V (capacity at least 30 mA).	<div style="display: flex; justify-content: space-around;"> <div style="text-align: center;"> X10 </div> <div style="text-align: center;"> X9 </div> </div> <p>2x RJ45: Pin No. 1 ... 8</p> <p>NOTE: For frequency inverters SK 530E and above, this CANopen interface can be used for the evaluation of an absolute encoder. Further details can be found in manual BU 0510.</p> <p>Recommendation: Provide strain relief (e.g. with EMC Kit)</p>	P503 P509
2				
3	CAN GND			
4	No function			
5				
6	Cable shield			
7	GND/0V			
8	External 24VDC voltage supply			

DIP switch 1/2 (top side of frequency inverter)

DIP-1	Termination resistor for RS485 interface (RJ12); ON = switched in [Default = "OFF"] For RS232 communication DIP1 to "OFF"	X11 	X10 X9
DIP 2	Terminal resistor for CAN/CANopen interface (RJ12); ON = switched in [Default = "OFF"]	RS232/485 	CAN/CANopen

Plug connector block X11 – RS485 / RS232

Relevance	SK 500E	SK 505E	SK 510E	SK 511E	SK 515E	SK 520E	SK 530E	SK 535E
	√	√	√	√	√	√	√	√
Terminals X11:	1	2	3	4	5	6		
Name	RS485 A +	RS485 A-	GND	232 TXD	232 RXD	+5V		

Contact	Function [factory setting]	Data	Description / wiring suggestion	Parameter
---------	----------------------------	------	---------------------------------	-----------

Note: Coupling of two frequency inverters via the RJ12 socket must only be made via the USS BUS (RS485). Care must be taken that no connection to the data cable **is possible via RS232**, in order to prevent damage to this interface.

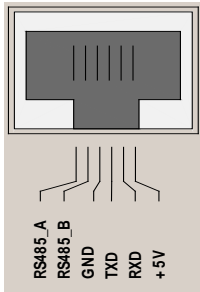
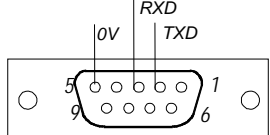
1	Data cable RS485	Baud rate 9600...38400 Baud	 <p>RJ12: Pin No. 1 ... 6</p>	P503 P509
2		Terminal resistance R=240 Ω DIP 1 (see below)		
3	Reference potential for bus signals (must always be wired!)	0 V digital		
4	Data cable RS232	Baud rate 9600...38400 Baud		
5				
6	Internal 5V supply voltage	5 V ± 20 %		
optional	Adapter cable RJ12 to SUB-D9 for RS232 communication for direct connection to a PC with NORD CON	Length 3 m Assignment of the SUB-D9 plug socket:	 <p>Part No. 278910240</p>	

DIP switch 1/2 (top side of frequency inverter)

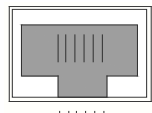
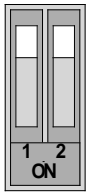
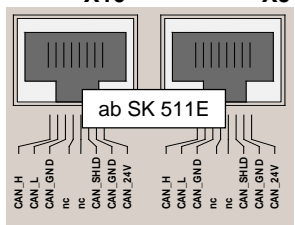
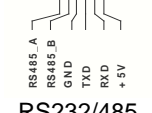
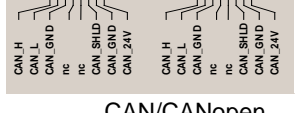
DIP-1	Termination resistor for RS485 interface (RJ12); ON = switched in [Default = "OFF"] For RS232 communication DIP1 to "OFF"	 <p>X11</p>	 <p>DIP</p>	 <p>X10 X9</p>
DIP 2	Terminal resistor for CAN/CANopen interface (RJ12); ON = switched in [Default = "OFF"]	 <p>RS232/485</p>		 <p>CAN/CANopen</p>

Terminal block X12 – 24 VDC input (only Size 5 ... 7)

Relevance	SK 500E	SK 505E	SK 510E	SK 511E	SK 515E	SK 520E	SK 530E	SK 535E	
					√			√	
Terminal X12:	40	44							
Designation	GND	VI 24V							

Terminal	Function [factory setting]	Data	Description / wiring suggestion	Parameter
44	Supply voltage input	24V ... 30V min. 1000mA	Connection optional If no control voltage is available, the control voltage can be supplied via an internal mains unit.	
40	Reference potential for digital signals	GND/0V	Reference potential	

Terminal block X13 – motor PTC (only size 5 ... 7)

Relevance	SK 500E	SK 505E	SK 510E	SK 511E	SK 515E	SK 520E	SK 530E	SK 535E	
					√			√	
Terminals X13:	T1	T2							
Name	T1	T1							

Terminal	Function [factory setting]	Data	Description / wiring suggestion	Parameter
T1	Thermistor input +	EN 60947-8 On: >3.6 kΩ Off: < 1.65 kΩ Measurement voltage 5 V at R < 4 kΩ	The function cannot be switched off, set a jumper if no PTC is present.	
T2	Thermistor input -			

Terminal block X15 – motor PTC and 24V input (above size 8)

Relevance	SK 500E	SK 505E	SK 510E	SK 511E	SK 515E	SK 520E	SK 530E	SK 535E
					√			√
Terminals X15:	38	39	44	40				
Name	T1	T2	VI 24V	GND				

Terminal	Function [factory setting]	Data	Description / wiring suggestion	Parameter
38	Thermistor input +	EN 60947-8 On: >3.6 kΩ	The function cannot be switched off, set a jumper if no PTC is present.	
39	Thermistor input -	Off: < 1.65 kΩ Measurement voltage 5 V at R < 4 kΩ		
44	Voltage supply input	24V ... 30V min. 3000mA	Voltage supply for the FI control unit. Is essential for the function of the frequency inverter.	
40	Reference potential for digital signals	GND/0V	Reference potential	

2.10 Colour and contact assignments for encoders

Encoder input X6

The incremental encoder connection is an input for a type with two tracks and TTL-compatible signals for EIA RS 422-compliant drivers. The maximum current consumption of the incremental encoder must not exceed 150 mA

The pulse number per rotation can be between 500 and 8192 increments. This is set with the normal scaling via parameter P301 "Incremental encoder pulse number" in the menu group "Control parameters". For cable lengths > 20 m and motor speeds above 1500 rpm the encoder should not have more than 2048 pulses/revolution.

For longer cable lengths the cable cross-section must be selected large enough so that the voltage drop in the cable is not too great. This particularly affects the supply cable, in which the cross-section can be increased by connecting several conductors in parallel.

Unlike incremental encoders, for sine encoders or SIN/COS encoders the signals are not in the form of pulses, but rather in the form of sine signals (shifted by 90°).



Information

Rotary encoder counting direction

The direction of rotation of the incremental encoder must correspond to that of the motor. Therefore, depending on the rotation direction of the encoder to the motor (possibly reversed), a negative number must be set in parameter P301.



Information

Rotary encoder function test

The voltage difference between tracks A and B can be measured with the aid of parameter P709 [-09] and [-10]. If the incremental encoder is rotated, the value of both tracks must jump between -0.8V and 0.8V. If the voltage only jumps between 0 and 0.8V the relevant rack is faulty. The position can no longer be reliably determined via the incremental encoder. We recommend replacement of the encoder!

Incremental encoder

According to the resolution (pulse number), incremental encoders generate a defined number of pulses for each rotation of the encoder shaft (Track A / Track A inverse) With this, the precise speed of the encoder or motor can be measured by the frequency inverter. By the use of a second track (B / B inverse) shifted by 90° (¼ period), the direction of rotation can also be determined.

The supply voltage for the encoder is 10-30V. The voltage source can be an external source or the internal voltage (according to the frequency inverter version: 12 V /15 V /24 V).

Special terminals are available for connection of a rotary encoder with TTL signals. Parameterisation of the corresponding functions is made with the parameters from the group "Control parameters" (P300 et seq.) TTL encoders enable the best performance for control of a drive unit with frequency inverters SK 520E and above.

The digital inputs DIN 2 and DIN 4 are used to connect an encoder with an HTL signal. Parameterisation of the corresponding functions is carried out with parameters P420 [-02/-04] or P421 and P423 as well as P461 – P463. In contrast to TTL encoders, HTL encoders only enable restricted performance for speed control (lower limit frequencies). However, they can be used with a considerably lower resolution and also for SK 500E

Function	Cable colours,for incremental encoder	Signal type TTL		Signal type HTL	
		Assignment for SK 5xxE Terminal block X5 or X6			
10-30 V supply	brown / green	42(/44 /49)	15V (/24V /12V)	42(/44 /49)	15V (/24V /12V)
0 V supply	white / green	40	GND/0V	40	GND/0V
Track A	brown	51	ENC A+	22	DIN2
Track A inverse	green	52	ENC A-	-	-
Track B	grey	53	ENC B+	24	DIN4
Track B inverse	pink	54	ENC B-	-	-
Track 0	red	-	-	-	-
Track 0 inverse	black	-	-	-	-
Cable shield	Connected to a large area of the frequency inverter housing or shielding angle				

Table 23: Colour and contact assignments for NORD – TTL / HTL incremental encoders



Information

Incremental encoder data sheet

If the equipment deviates from the standard equipment (Type 5820.0H40, 10-30V encoder, TTL/RS422 or encoder type 5820.0H30, 10-30V encoder, HTL) for the motors, please note the accompanying data sheet or consult your supplier.

2.11 RJ45 WAGO- Connection module

This adapter module can be used for the simple wiring of functions of the RJ45 connection (24V supply voltage, CANopen absolute encoder, CANbus) with normal cables.

Pre-assembled RJ45 patch cables are connected to the spring-loaded terminals (1-8 + S) with this adapter.

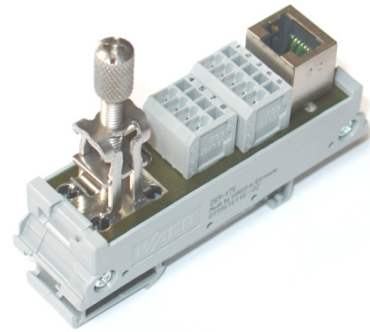

Contact	1	2	3	4	5	6	7	8	S
Meaning	CAN_H	CAN_L	CAN_GND	nc	nc	CAN_SHD	CAN_GND	CAN_24V	Shield

The shield clamp should be used in order to ensure the correct connection and relief of tension on the shield.

Supplier	Name	Article number
WAGO Kontakttechnik GmbH	Ethernet connection module with CAGE CLAMP connection RJ45 transfer module	289-175
WAGO Kontakttechnik GmbH	Accessories: WAGO shield clamp	790-108
Alternative, complete connection module and shield clamp		Part No.
Getriebbau NORD GmbH & Co.KG	Adapter module RJ45/terminal	278910300

Table 24: RJ45 WAGO connection module

3 Displays and control

As delivered, without the technology unit, 2 LEDs (green/red) are visible externally. These indicate the actual device status.

The **green LED** indicates that the mains voltage is present and operational, while a flashing code that increases in speed shows the degree of overload at the frequency inverter output.

The **red LED** signals actual error by flashing with a frequency which corresponds to the number code of the fault (please see chapter 6 "Operating status messages").

3.1 Modular assemblies SK 5xxE

By the use of various modules for display, control and parameterisation, the SK 5xxE can be easily adapted to a wide range of requirements.

Alphanumerical display and operating modules can be used for simple commissioning. For more complex tasks, various connections to a PC or an automation system can be selected.

The **Technology Unit (Technology Unit, SK TU1-...)** is connected externally to the front of the frequency inverter and is therefore easy to access and replace at any time.

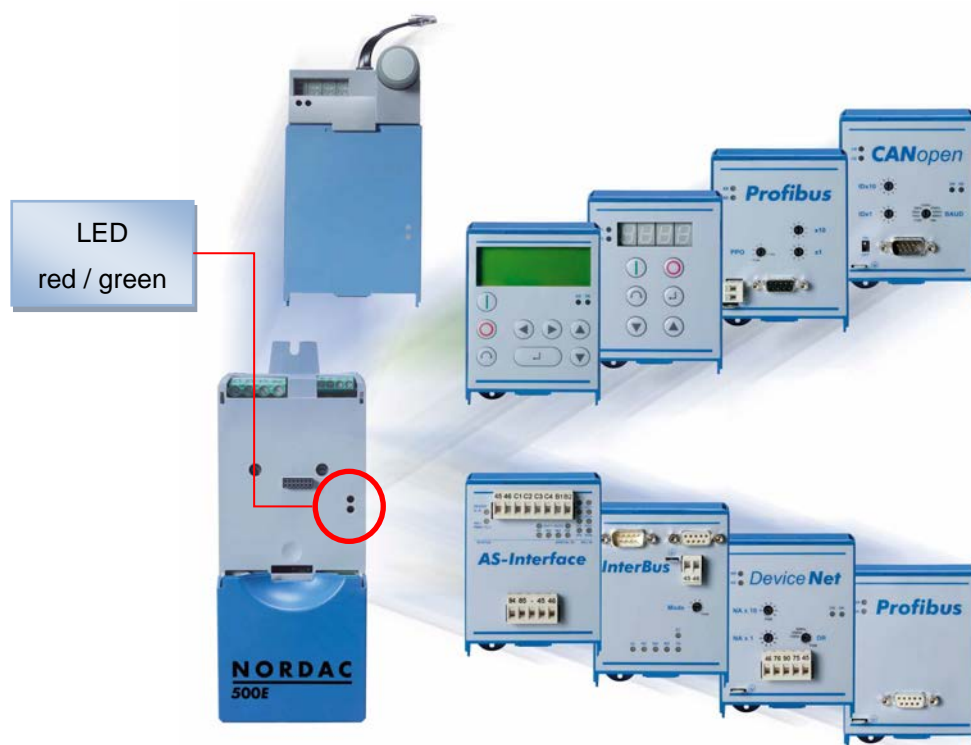

Fig. 9: Modular assemblies SK 5xxE

3.2 Overview of technology units

Detailed information about the options listed below can be found in the relevant documentation.

Control boxes

Module	Name	Description	Data	Part No.	Document
SK CSX-0	SimpleBox	Commissioning, parameterisation and control of the frequency inverter	7-segment, 4-digit LED display, single button control	275900095	BU 0500 (chapter 3.3)
SK TU3-CTR	ControlBox	As for SK CSX-0 + saving of the parameters of an inverter	7-segment, 4-digit LED display, keyboard	275900090	BU 0040
SK TU3-PAR	ParameterBox	As for SK CSX-0 + saving of parameters from up to 5 inverters	4-line LCD display (illuminated), keyboard	275900100	BU 0040
SK TU3-POT	PotentiometerBox	Direct control of the FI	ON, OFF, R/L, 0...100%	275900110	BU 0500 (chapter 3.3.1)

Table 25: Overview of Technology Units and Control Boxes

Interfaces

Module	Interface	Data	Part No.	Document
<i>Normal field bus protocols</i>				
SK TU3-AS1	AS Interface	4 sensors / 2 actuators 5/8 pin screw terminals	275900170	BU 0090
SK TU3-CAO	CANopen	Baud rate 1 Mbit/s Connector: Sub-D9	275900075	BU 0060
SK TU3-DEV	DeviceNet	Baud rate: 500 KBit/s 5-pole screw terminal	275900085	BU 0080
SK TU3-IBS	InterBus	Baud rate: 500 kBit/s (2Mbit/s) Connector: 2 x Sub-D9	275900065	BU 0070
SK TU3-PBR	Profibus DP	Baud rate: 1.5 MBaud Connector: Sub-D9	275900030	BU 0020
SK TU3-PBR-24V	Profibus DP	Baud rate: 12 MBaud Connector: Sub-D9 24V DC connection via terminal	275900160	BU 0020

Module	Interface	Data	Part No.	Document
<i>Ethernet-based Bus systems</i>				
SK TU3-ECT	EtherCAT	Baud rate: 100 MBaud Connector: 2 x RJ45 24V DC connection via terminal	275900180	BU 0570 and TI 275900180
SK TU3-EIP	EtherNet IP	Baud rate: 100 MBaud Connector: 2 x RJ45 24V DC connection via terminal	275900150	BU 2100 and TI 275900150
SK TU3-PNT	PROFINET IO	Baud rate: 100 MBaud Connector: 2 x RJ45 24V DC connection via terminal	275900190	BU 0590 and TI 275900190
SK TU3-POL	POWERLINK	Baud rate: 100 MBaud Connector: 2 x RJ45 24V DC connection via terminal	275900140	BU 2200 and TI 275900140

Table 26: Overview of Technology Units and Bus Systems

Note
USS Bus modules and Modbus RTU

No optional modules are required for communication via USS or Modbus RTU.

The protocols are integrated into all SK 5xxE series devices. An interface is available via terminal X11, or if present, also via X7:73/74.

A detailed description of both of these protocols can be found in Manual BU 0050.

Other optional modules

Module	Interface	Data	Part No.	Document
SK EBGR-1	Electronic brake rectifier	Extension for direct control of an electro-mechanical brake, IP20, snap-on rail mounting	19140990	TI 19140990
SK EBIOE-2	IO extension	Extension with 4 DIN, 2 AIN, 2 DOUT and 1 AOOUT, IP20, snap-on rail mounting, SK 54xE and higher	275900210	TI 275900210

Table 27: Overview of technology units, other optional modules

Installation

Information

Installing the SK TU4-PNT-... technology unit

Modules should not be inserted or removed unless the device is free of voltage. The slots may only be used for the intended modules.

Installation of a technology unit **separate** from the frequency inverter is not possible. It must be connected directly to the frequency inverter.

The technology units must be **installed** as follows:

1. Switch off the mains voltage, observe the waiting period.
2. Push the control terminals cover down slightly or remove.
3. Remove the **blank cover** by loosening the release on the lower edge and pulling off with an upward turning movement.
4. Hook the **technology unit** onto the upper edge and press in lightly until it engages.



Take care that the plug connection bar is properly contacted and if necessary fix it with a suitable screw (self-tapping screw 2.9 mm x 9.5 mm, included in the scope of delivery of the frequency inverter).

5. Close the control terminal cover again.

3.3 SimpleBox, SK CSX-0

This option is used as a simple parameterisation, display and control tool for the frequency inverter SK 5xxE. even in active BUS operation, data can be read out and parameterisation made especially if the frequency inverter slot is occupied with a BUS unit.

Features

- 4-digit, 7-segment LED display
- Single button operation of the frequency inverter
- Display of the active parameter set and operating value

After the SimpleBox has been attached, the cable connectors plugged in and the mains has been switched on, horizontal lines appear in the 4-digit 7-segment display. This display signals the operational readiness of the frequency inverter.

If a jog frequency value is pre-set in parameter P113, or a minimum frequency is pre-set in P104, the display flashes with this value.

If the frequency inverter is enabled, the display changes automatically to the operating value selected in parameter >Selection Display value< P001 (factory setting = current frequency).

The actual parameter set is shown by the 2 LEDs next to the display on the left in binary code.



Fig. 10 SimpleBox SK CSX-0

NOTICE

Parallel operation of control elements

The SimpleBox SK CSX 0 must **not** be used in combination with the SK TU3-POT, SK TU3-CTR, SK TU3-PAR, the handheld control units SK ...- 3H or their built-in versions SK ...-3E or the Remote control window of the NORD CON software. As all of these elements use the same communication channel, this may cause communication errors.

Assembly

The SimpleBox can be attached to any technology unit (SK TU3-...) or to the blind cover. To remove it, simply pull it off after the RJ12 connection has been detached (press in the latching lever on the RJ12 connector).

Connection

The SimpleBox is connected to the socket at the upper edge of the frequency inverter using the RJ12 connector/cable.

The Bus termination resistor for the RS485 interface must be set with DIP switch 1 (left).

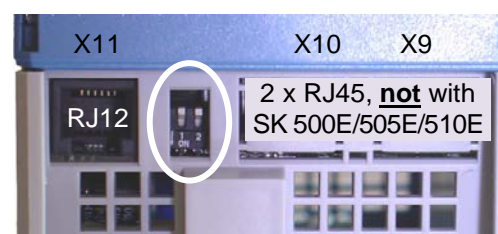

Fig. 11 Top side of FI with RJ12 / RJ45 connection

Functions of the SimpleBox



<p>7-segment LED display</p>	<p>When the frequency inverter is ready for operation any initial value (P104/P113 for keyboard operation) is indicated by a flashing display. This frequency is immediately used on being enabled.</p> <p>During operation, the currently set operating value (selection in P001) or an error code (Section 6) is displayed.</p> <p>During parameterisation, the parameter numbers or the parameter values are shown.</p>
<p>LEDs</p> 	<p>The LEDs indicate the actual operating parameter set in the operating display (P000) and the current parameter set being parameterised. The display is in binary code.</p> 
<p>Turn the knob to the right</p>	<p>Turn the knob to the right in order to increase the parameter number or the parameter value.</p>
<p>Turn the knob to the left</p>	<p>Turn the knob to the left in order to reduce the parameter number or the parameter value.</p>
<p>Briefly press the knob</p>	<p>Briefly pressing the knob = "ENTER" function in order to store a changed parameter or to change from parameter number to parameter value.</p>
<p>Press the knob for longer</p>	<p>If the knob is pressed for a longer period, the display changes to the next higher level, if necessary without storing a parameter change.</p>

Table 28: SimpleBox SK CSX-0, functions

Control with the SimpleBox

If P549=1 is set and the operating value display P000 is selected, the drive can be controlled with the SimpleBox on the FI.

Depressing the button for a long time starts the drive, pressing briefly stops it. The speed of rotation can be controlled in the positive and negative range by means of the rotating knob.

Note

Stopping the drive

In this operating mode, the drive can only be stopped with the button in the operating value display (short press) or by switching off the mains voltage.

Menu structure with the SimpleBox

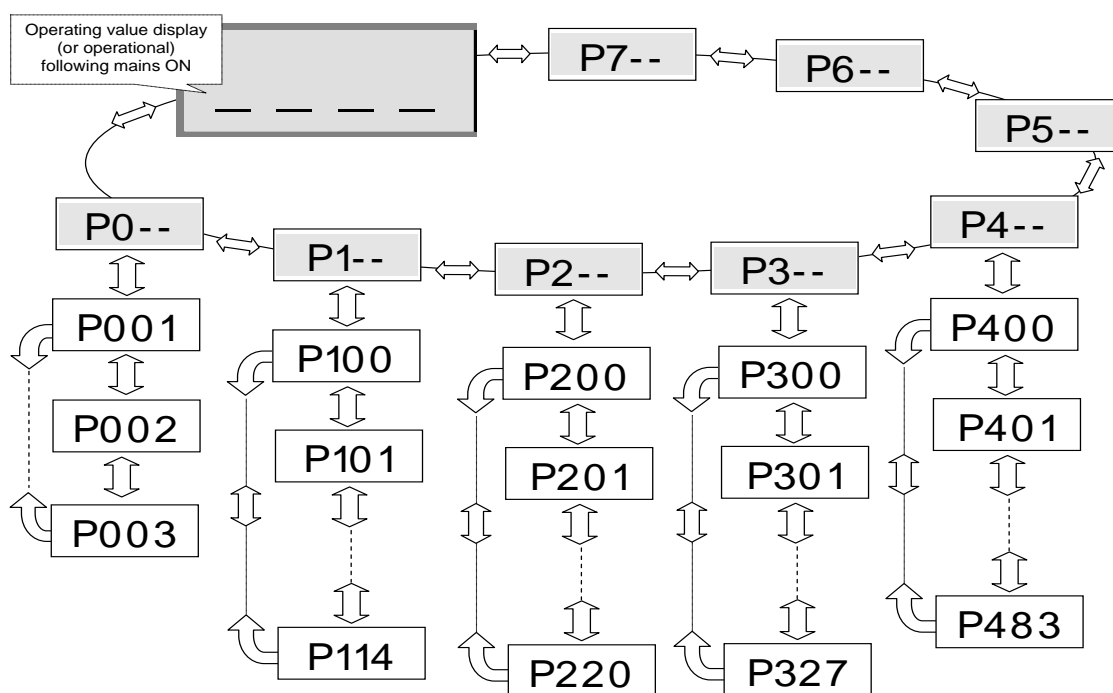
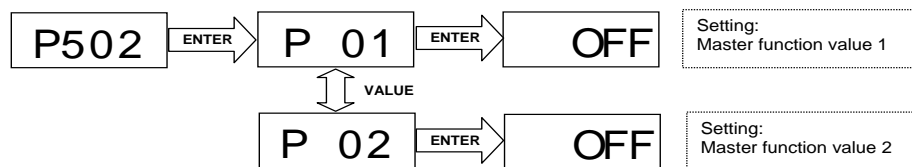

Fig. 12: SimpleBox, SK CSX-0 menu structure

NOTE: Some parameters, e.g. P465, P475, P480...P483, P502, P510, P534, P701...P706, P707, P718, P740/741 and P748 have additional levels (arrays), in which further adjustments can be made, e.g.:



3.3.1 PotentiometerBox, SK TU3-POT

The frequency inverter can be controlled directly from the device using the PotentiometerBox. No additional external components are required.







The motor can be started, stopped and the direction of rotation changed by means of the buttons. A change of direction of rotation is triggered by pressing the *Start* or *Stop* keys for approx. 3 sec..

The required frequency setpoint for starting after enabling (green key) is set with the potentiometer.

The LEDs indicate the status of the FI. If an inactive error is present (red LED flashing), this can be acknowledged by pressing the STOP key



Note: The PotentiometerBox must be activated via parameter P549 “PotentiometerBox Function” using the setting {1} “Setpoint frequency”.

I/O key	START/STOP (green/red)	To enable or block the output signal.	
Potentiometer	0 ... 100%	Sets the output frequency between f_{min} (P104) and f_{max} (P105).	
Red LED	Off		No error
	Flashing		Inactive error
	On		Active error
Green LED	Off		Frequency inverter switched off, enabled with rotation direction to the right
	Flashing 1: short on, long off		Frequency inverter switched off, enabled with rotation direction to the left
	Flashing 2: short on, short off		Inverter switched on with direction of rotation to the left
	On		Inverter switched on with direction of rotation to the right

3.4 Connection of multiple device to a parameterisation tool

In principle it is possible to access several frequency inverters via the **ParameterBox** or the **NORD CON software**. In the following example, communication is made via the parameterisation tool, by tunnelling the protocols of the individual devices (max. 8) via the common system bus (CAN). The following points must be noted:

1. Physical bus structure

Establish a CAN connection (system bus) between the devices (Terminal: X9 or X10 (Type: RJ 45))

2. Supply electricity (24 V) to the CAN bus. Establish the connection, for example via the RJ45 – WAGO connection module (please see chapter 2.11 "RJ45 WAGO- Connection module")

3. Parameterisation

Parameter		Settings on the inverter							
No.	Designation	FI 1	FI 2	FI 3	FI 4	FI 5	FI 6	FI 7	FI 8
P503	Leading function output	4 (system bus active)							
P512	USS address	0	0	0	0	0	0	0	0
P513	Telegram time-out (s)	0.6	0.6	0.6	0.6	0.6	0.6	0.6	0.6
P514	CAN bus baud rate	5 (250 kBaud)							
P515	CAN bus address	32	34	36	38	40	42	44	46

To adopt the addresses, the 24 V supply of the CAN bus must be completely switched off for approx. 30 sec.

4. Connect the parameterisation tool as usual via RS485 (Terminal: X11 (Type: RJ12)) to the **first** frequency inverter.

Conditions / Restrictions:

- In order to use the complete range of functions the **first** frequency inverter (*FI 1*) must at least correspond to the firmware status 2.2 R0 (SK 54xE) or 3.0 R0 (all other SK 5xxE devices).
- All other connected frequency inverters from the series must at least have a firmware status of 2.1 R0, in order to display the devices 5 ... 8 correctly. Devices with a firmware version which is older than 1.8 R0 do not have the required functionality.
- If NORDCON is connected to an inverter other than *FI 1*, the status of *FI 1* will be displayed as "Not ready". The status of devices 5 – 8 will also be displayed as "Not ready" if they have a software status which is older than 2.1 R0.
- The parameterisation tools must also correspond to the latest software status:

NORDCON	≥ 02.03.00.21
ParameterBox	≥ 4.5 R3.

4 Commissioning

Once the power supply has been connected to the frequency inverter, it will be operational within a few moments. In this state, the frequency inverter can be set to the requirements of the application, i.e. it can be parameterised (please see chapter 5 "Parameters").

The connected motor may only be started after the parameters specific to the application in question have been set by qualified personnel.

⚠ DANGER!

Danger to life

The frequency inverter is not equipped with a line main switch and is therefore always live when connected to the power supply. Live voltages may therefore be connected to a connected motor at standstill.

4.1 Factory settings

All frequency inverters supplied by Getriebebau NORD are pre-programmed with the default setting for standard applications with 4 pole IE1 three-phase motors (same voltage and power). For use with motors with other powers or number of poles, the data from the rating plate of the motor must be input into the parameters P201...P207 under the menu item >Motor data<.

NOTE: All data for IE1 motors can be pre-set with parameter P200. After use of this function has been successful, this parameter is reset to 0 = no change! The data is loaded automatically into parameters P201...P209 – and can be compared again with the data on the motor rating plate.

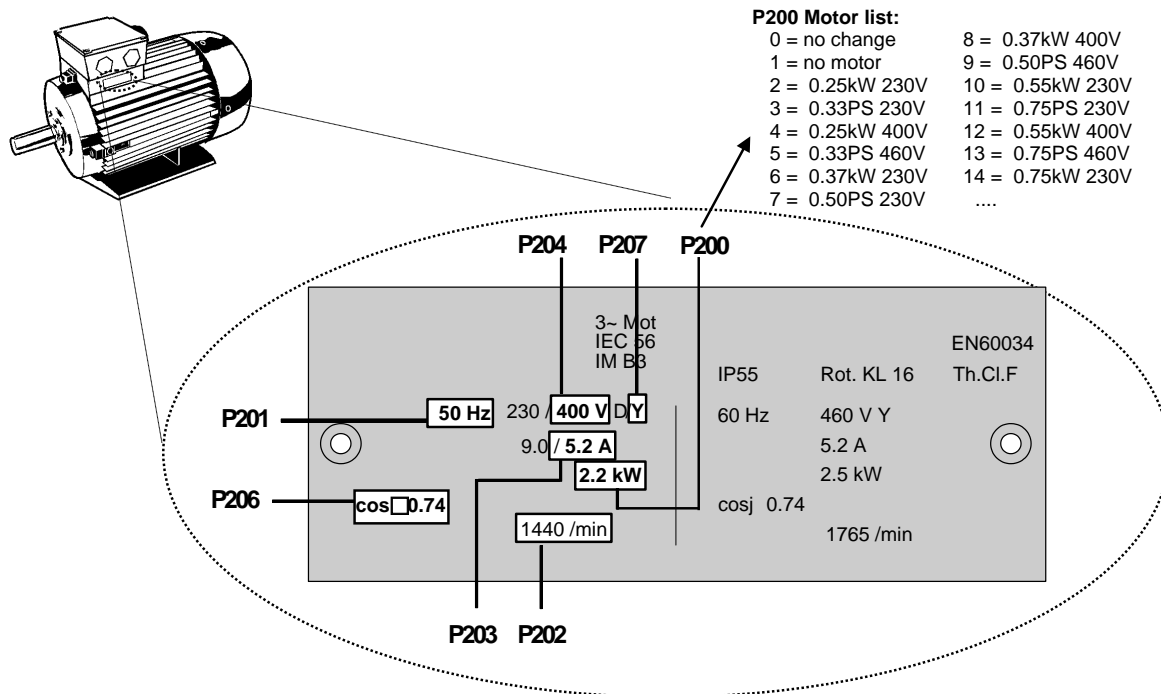

Fig. 13 Motor type plate

RECOMMENDATION: For the correct operation of the drive unit, it is necessary to input the motor data (rating plate) as precisely as possible. In particular, an automatic stator resistance measurement using parameter P220 is recommended.

In order to automatically determine the stator resistance, set P220 = 1 and then confirm by pressing "ENTER". The value calculated for the line resistance (dependent upon P207) will be saved in P208.

4.2 Selecting the operating mode for motor control

The frequency inverter is able to control motors with all efficiency classes (IE1 to IE4). Motors which we manufacture are produced as asynchronous motors in efficiency classes IE1 to IE3, whereas IE4 motors are produced as synchronous motors.

Operation of IE4 motors has many special features with regard to the control technology. In order to enable the optimum results, the frequency inverter was specially designed for the control of NORD IE4 motors, whose construction corresponds to an IPMSM type (Interior Permanent Magnet Synchronous Motor). In these motors, the permanent magnets are embedded in the rotor. The operation of other brands must be checked by NORD as necessary. Also refer to the technical information [TI 80-0010](#) "Planning and commissioning guidelines for NORD IE4 motors with NORD frequency inverters".

4.2.1 Explanation of the operating modes (P300)

The frequency inverter provides different operating modes for the control of a motor. All operating modes can be used with either an ASM (asynchronous motor) or a PMSM (Permanent Magnet Synchronous Motor), however various constraints must be complied with. In principle, all these methods are "flux oriented control methods".

1. VFC open-loop mode (P300, setting "0")

This operating mode is based on a voltage-governed flux oriented control method (Voltage Flux Control Mode (VFC)). This is used for both ASMs as well as PMSMs. In association with the operation of asynchronous motors this is often referred to as "ISD control".

Control is carried out without the use of encoders and exclusively on the basis of fixed parameters and the measurement results of actual electrical values. No specific control parameter settings are necessary for the use of this mode. However, parameterisation of the precise motor data is an essential prerequisite for efficient operation.

As a special feature for the operation of an ASM there is also the possibility of control according to a simple V/f characteristic curve. This mode of operation is important if several motors which are not mechanically coupled are to be operated with a single frequency inverter, or if it is only possible to determine the motor data in a comparatively imprecise manner.

Operation according to a V/f characteristic curve is only suitable for drive applications with relatively low demands on the quality of speed control and dynamics (ramp times ≥ 1 s). For machines which tend to have relatively large mechanical vibrations due to their construction, control according to a V/f characteristic curve can also be advisable. Typically, V/f characteristic curves are used to control fans, certain types of pump drives or agitators. Operation according to a V/f characteristic curve is activated via parameters (P211) and (P212) (each set to "0").

2. CFC closed-loop mode (P300, setting "1")

In contrast to the "0" setting "VFC open-loop mode" this is a form of control with current controlled flux orientation (Current Flux Control). For this operating mode, which for ASMs is functionally identical to the previously used designation "servo control", use of an encoder is essential. The precise speed behaviour of the motor is detected and included in the calculation for control of the motor. Determination of the position of the rotor is also possible through the use of the encoder, whereby the initial value of the rotor position must also be determined for the operation of a PMSM. This enables even more precise and rapid control of the drive unit.

This operating mode provides the best possible results for the control behaviour of both ASMs and PMSMs and is especially suitable for lifting equipment applications or applications with requirements for the highest possible dynamic behaviour (ramp times $\geq 0,05$ sec). The greatest advantage of this operating mode is gained in combination with an IE4 motor (energy efficiency, dynamics, precision).

3. CFC open-loop –mode (P300, setting "2")

CFC mode is also possible with the open-loop method, i.e. in operation without an encoder. Here, the speed and position detection are determined by "observation" of measurements and setting values. Precise setting of the current and speed controller is also essential for this operating mode. This mode is especially suitable for applications with higher demands for dynamics in comparison with VFC control (ramp times ≥ 0.25 s) and e.g. also for pump applications with high starting torques).

4.2.2 Overview of control parameter settings

The following provides an overview of all parameters which are of importance, depending on the selected operating mode. Among other things, a distinction is made between "relevant" and "important", which provides an indication of the required precision of the particular parameter setting. However, in principle, the more precisely the setting is made, the more exact the control, so that higher values for dynamics and precision are possible for the operation of the drive unit. A detailed description of these parameters can be found in Section 5 "Parameters".

		"∅" = Parameter has no significance		"- " = Leave the parameter in the factory setting		"√" = Setting of the parameter is relevant		"! " = Setting of the parameter is important	
Group	Parameter	Operating mode							
		VFC open-loop		CFC open-loop		CFC closed-loop			
		ASMs	PMSMs	ASMs	PMSMs	ASMs	PMSMs		
Motor data	P201 ... P209	√	√	√	√	√	√		
	P208	!	!	!	!	!	!		
	P210	√ ¹⁾	√	√	√	∅	∅		
	P211, P212	- ²⁾	-	-	-	-	-		
	P215, P216	- ¹⁾	-	-	-	-	-		
	P217	√	√	√	√	∅	∅		
	P220	√	√	√	√	√	√		
	P240	-	√	-	√	-	√		
	P241	-	√	-	√	-	√		
	P243	-	√	-	√	-	√		
	P244	-	√	-	√	-	√		
	P246	-	√	-	√	-	√		
P245, 247	-	√	∅	∅	∅	∅			

Group		Parameter	Operating mode					
			VFC open-loop		CFC open-loop		CFC closed-loop	
			ASMs	PMSMs	ASMs	PMSMs	ASMs	PMSMs
Controller data	P300		√	√	√	√	√	√
	P301		∅	∅	∅	∅	!	!
	P310 ... P320		∅	∅	√	√	√	√
	P312, P313, P315, P316		∅	∅	-	√	-	√
	P330 ... P333		-	√	-	√	-	√
	P334		∅	∅	∅	∅	-	√

¹⁾ = For V/f characteristic curve: precise matching of the parameter is important.
²⁾ = For V/f characteristic curves: typical setting "0"

4.2.3 Motor control commissioning steps

The most important commissioning steps are mentioned below in their ideal order. Correct assignment of the inverter / motor and the mains voltage is assumed. Detailed information, especially for optimisation of the current, speed and position control of asynchronous motors is described in the guide "Control optimisation" (AG 0100). Detailed commissioning and optimisation information for PMSM in CFC closed loop operation can be found in the "Drive optimisation" guideline (AG 0101). Please contact our Technical Support.

1. Carry out the motor connection as usual (note Δ / Y !). Connect the encoder, if present
2. Connect the mains supply.
3. Carry out the factory setting (P523)
4. Select the basic motor from the motor list (P200) (ASM types are at the beginning of the list, PMSM types are at the end, designated by their type (e.g. ...80T...))
5. Check the motor data (P201 ... P209) and compare with the type plate / motor data sheet
6. Measure the stator resistance (P220) → P208, P241[-01] are measured, P241[-02] is calculated.
(Note: is an SPMSM is used, P241[-02] must be overwritten with the value from P241[-01])
7. Rotary encoder: Check the settings (P301, P735)
8. Select the operating mode (P300)
9. with PMSM only:
 - a. EMF voltage (P240) → motor type plate / motor data sheet
 - b. Determine / set reluctance angle (P243) (not required with NORD motors)
 - c. Peak current (P244) → motor data sheet
 - d. Only for PMSMs in VFC mode:
determine (P245), (P247)
 - e. Determine (P246)
10. Determine / adjust the current control (P312 – P316)
11. Determine / adjust the speed control P310, P311)
12. PMSM only:
 - a. Select the control method (P330)
 - b. Make the settings for the starting behaviour (P331 ... P333)
 - c. Make the settings for the 0 pulse of the encoder P334 ... P335)

4.3 Minimal configuration of control connections

If the frequency inverter is to be controlled via the digital and analog inputs, this can be implemented immediately in the condition as delivered. Settings are not necessary for the moment.

Minimum connections

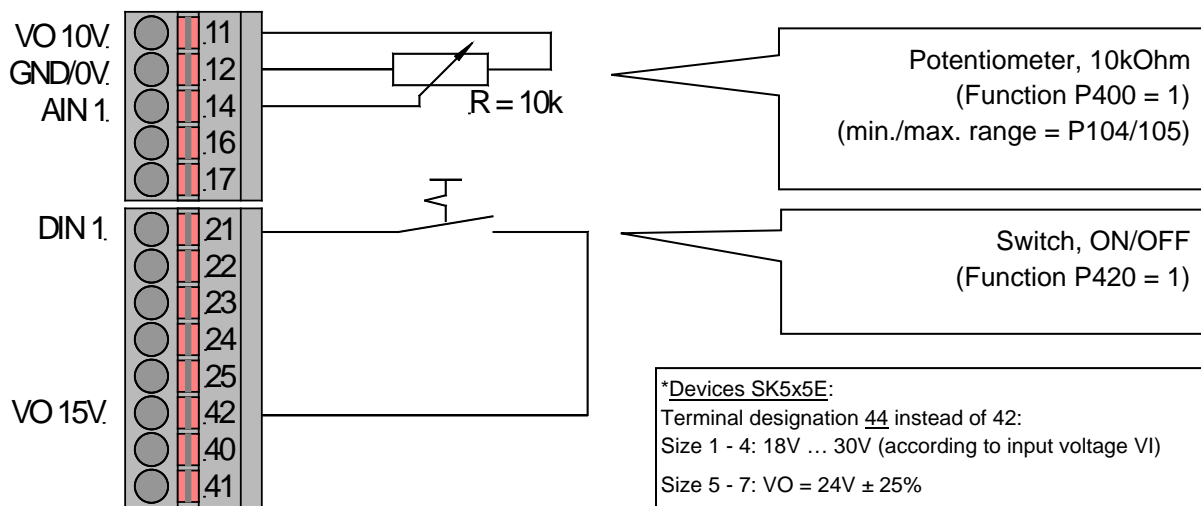

Basic parameters

If the current setting of the frequency inverter is not known, loading the default setting is recommended → P523 = 1. The inverter is pre-programmed for standard applications in this configuration. If necessary, the following parameters can be adjusted with the optional SimpleBox SK CSX-0 or ControlBox TU3-CTR.

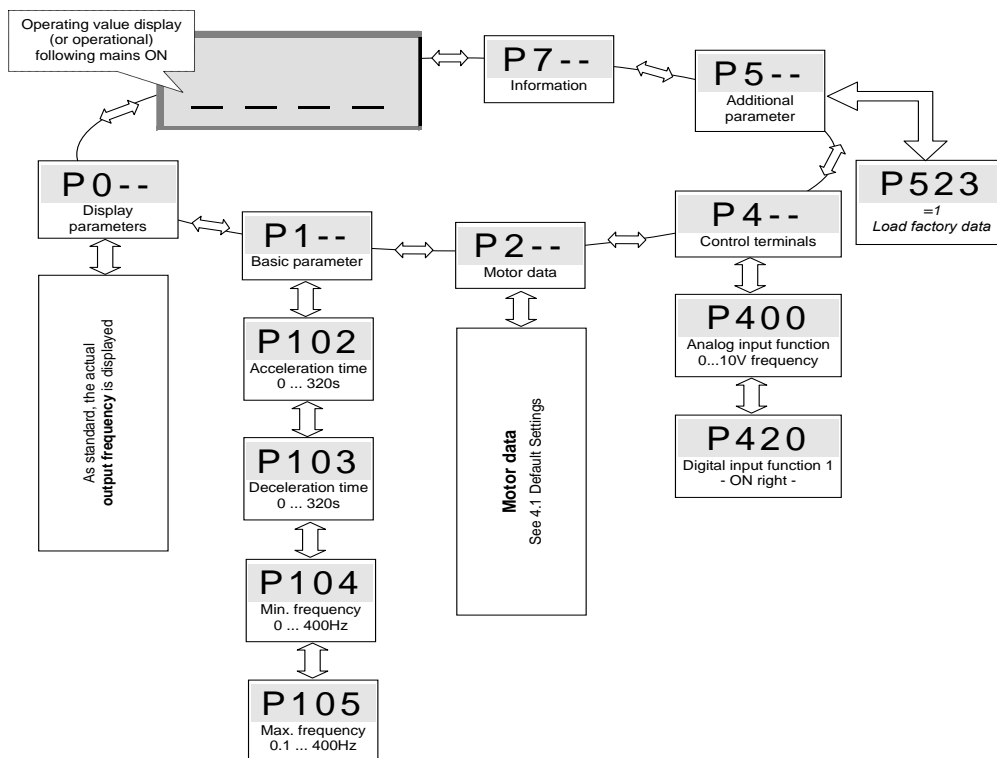

4.4 KTY84-130 connection (above software version 1.7)

The current vector control of the SK 500E series can be further optimised by the use of a KTY84-130 temperature sensor ($R_{th(0^{\circ}C)}=500\Omega$, $R_{th(100^{\circ}C)}=1000\Omega$). In particular there is the advantage that after an intermediate mains switch-off during operation the temperature of the motor is measured directly and therefore the actual value is always available to the frequency inverter. With this, the regulator can always achieve optimum speed precision.

Connections (Example SK 500E, analog input 2)

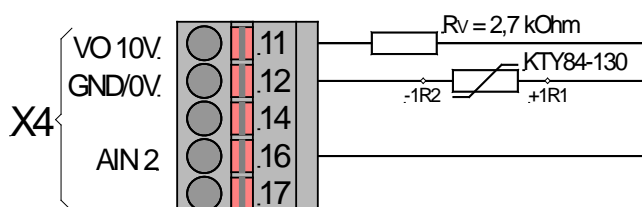

Parameter settings (Example SK 500E, analog input 2)

The following parameters must be set for the function of the KTY84-130.

1. Set the motor data **P201-P207** according to the type plate
2. Determine the motor stator resistance **P208** at $20^{\circ}C$ with **P220=1**.
3. Analog input 2 function, **P405=48** (Motor temperature)
4. Analog input 2 mode 2, **P406=1** (taking negative temperatures into account)
5. Matching of analog input 2: **P407= 1.54 V** and **P408= 2.64 V** (with $R_v=2.7\text{ k}\Omega$)
6. Adjust time constants: **P409=400ms** (Maximum value of filter time constant)
7. Motor temperature control: **P001=23** (Temperature display, operation display SK TU3-CTR / SK CSX-0)

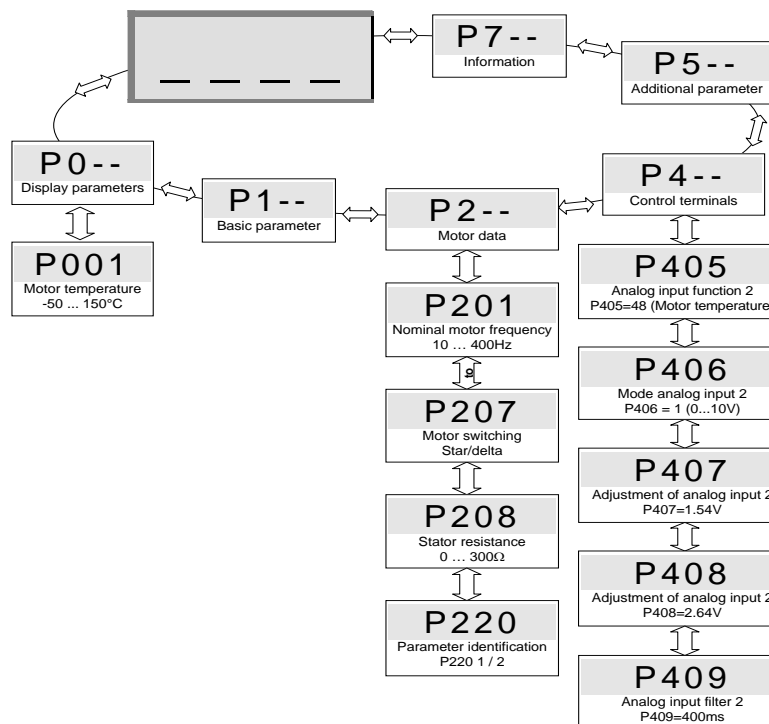

Note

Temperature ranges

Excess temperature of the motor is also monitored and at $155^{\circ}C$ (switching threshold for the thermistor) causes the drive unit to shut down with error message E002.

To determine the stator resistance of the motor, the temperature range $15 \dots 25^{\circ}C$ should not be exceeded.

Information



Pay attention to polarity

KTY sensors are wired semiconductors that must be operated in the conducting direction. In order to do this, the anode must be connected to the "+" contact of the analogue input. The cathode must be connected to the "-" ground or ground contact of the analogue input.

Failure to observe this can lead to erroneous measurements. Motor winding protection will no longer be guaranteed.

4.5 Frequency addition and subtraction via operating boxes

(software version 1.7 and above)

If the parameter P549 (PotentiometerBox Function) is set to 4 “Frequency addition” or 5 “Frequency subtraction”, a value can be added or subtracted via the **value keys**  or  with the ControlBox or the ParameterBox.

If the ENTER key  is confirmed, the value is saved in P113. The next time the device is started, the value will be added or subtracted immediately.

As soon as the inverter is enabled, the ControlBox switches to the operating display. With the ParameterBox, a change of value can only be made in the operating display. If the ControlBox is enabled, parameterisation is no longer possible. Enabling via the ControlBox or ParameterBox is also no longer possible in this mode, even if P509 = 0 and P510 = 0.

Note: In order to safely activate the ParameterBox in this mode, the STOP key  must be pressed once.

5 Parameters

Every frequency inverter is factory-set for a motor of the same power. All parameters can be adjusted "online". There are four switchable parameter sets available during operation. As delivered, all parameters are visible; however, some can be hidden with parameter P003.

NOTICE

Operating faults

As there are dependencies between parameters, it is possible for invalid internal data and operating faults to be generated briefly. Only the inactive or non-critical parameter sets should be adjusted during operation.

The individual parameters are combined into various groups. The first digit of the parameter number indicates the assignment to a **menu group**:

Menu group	No.	Master function
Operating displays	(P0--)	For the selection of the physical units of the display value.
Basic parameters	(P1--)	Contain the basic inverter settings, e.g. switch on and switch off behaviour and, along with the motor data, and are sufficient for standard applications.
Motor data	(P2--)	Settings for the motor-specific data, important for ISD current control, and selection of characteristic curve during the setting of dynamic and static boost.
Speed control (SK 520E or higher)	(P3--)	Settings for the control parameters (current controller, speed controller, etc.) with speed feedback.
Control terminals	(P4--)	Analog input and output scaling, specification of digital input and relay output functions, as well as PID controller parameters.
Additional parameters	(P5--)	Functions dealing with e.g. the interface, pulse frequency or error acknowledgement.
Positioning (SK 52xE and higher)	(P6--)	Setting of the positioning function. Details: please refer to BU 0510.
Information	(P7--)	Display of e.g. actual operating values, old error messages, equipment status reports or software version.
Array parameters	-01 ... -xx	Some parameters in these groups can be programmed and read in several levels (arrays). After the parameter is selected, the array level must also be selected.

Note

Parameter P523

Parameter P523 can be used to load the factory settings for all parameters at any time. This can be helpful, e.g. during the commissioning of a frequency inverter whose parameters no longer correspond with the factory settings.

All actual parameter settings will be overwritten, if P523= 1 is set and confirmed with "ENTER".

To safeguard the actual parameter settings, these can be transferred to the ControlBox (P550=1) or ParameterBox memories

Availability of parameters

Due to certain configurations, the parameters are subject to certain conditions. The following tables list all parameters together with the particular information.

Parameter {Werkeinstellung}	Einstellwert / Beschreibung / Hinweis		Supervisor	Parameter- satz
P401 <input type="text"/> [-01] <input type="text"/> ... <input type="text"/> [-06]	Modus Analog-Ein. (Modus Analogeingang)	<input type="text"/>	S	P
0 ... 5 { alle 0 }	In diesem Parameter wird bestimmt, wie der Frequenzumrichter auf ein Analogsignal, das den 0% Abgleich (P402) unterschreitet, reagieren soll.	ab SK 520E		

- 1 Parameter number
- 2 Array values
- 3 Parameter text; Top: P-Box display, bottom: Meaning
- 4 Special features (e.g.: only available for SK 520E and above)
- 5 Supervisor parameters (S) are dependent on the settings in P003
- 6 Parameter set dependent (P) parameter selections in P100
- 7 Parameter value range
- 8 Description of the parameter
- 9 Default values (factory settings) of the parameter

Array parameter display

Some parameters have the option of displaying settings and views in several levels (arrays). After the parameter is selected, the array level is displayed and must then also be selected.

If the ControlBox is used, the array level is shown by . With the ParameterBox (picture on right) the selection options for the array level appear at the top left of the display.

For parameterisation with ControlBox SK TU3-CTR:

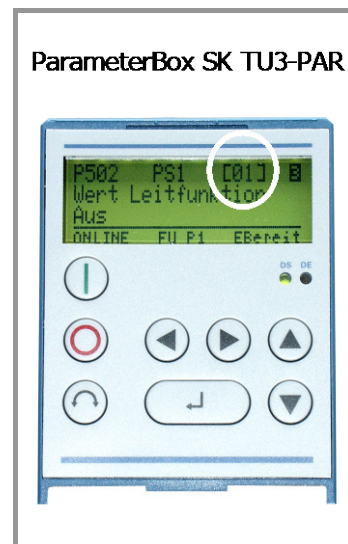
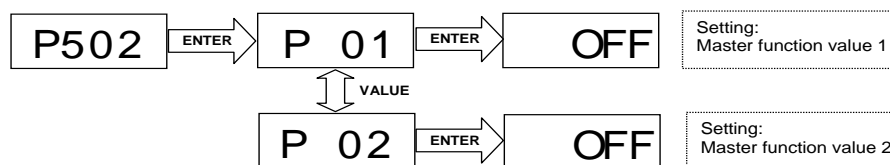

Operating displays

Abbreviations used:

- **FI** = Frequency inverter
- **SW** = Software version, stored in P707.
- **S = Supervisor parameters** are visible or hidden depending on P003.

Parameter {factory setting}	Setting value / Description / Note		Supervisor	Parameter set
P000	Operating display (<i>Operating parameter display</i>)			
0.01 ... 9999	In ParameterBoxes with 7-segment displays (e.g. SimpleBox) the operating value which is selected in P001 is displayed <i>online</i> . Important information about the operating status of the drive can be read out as required.			
P001	Display selection (<i>Display selection</i>)			
0 ... 65 { 0 }	Selection of operating display of a parametrisation box with 7-segment display (e.g.: SimpleBox)			
	0 = Actual frequency [Hz] Currently supplied output frequency			
	1 = Speed [rpm] Calculated speed			
	2 = Target frequency [Hz] Output frequency that corresponds to the pending setpoint. This need not correspond with the current output frequency.			
	3 = Current [A] Current measured output current			
	4 = Actual torque current [A]: Torque-forming output current			
	5 = Voltage [V AC] Current alternating voltage present at the device output			
	6 = Link voltage [V DC] The <i>Link voltage [Vdc]</i> is the FI-internal DC voltage. Amongst other things, this depends on the level of the mains voltage.			
	7 = cos Phi Current calculated value of the power factor			
	8 = Apparent power [kVA] Calculated current apparent power			
	9 = Effective power [kW] Calculated current effective power			
	10 = Torque [%] Calculated current torque			
	11 = Field [%] Calculated current field in motor			
	12 = Hours of operation [h] Time for which main voltage present at device			
	13 = Operating time Enable [h] " <i>Enabled operating hours</i> " is the time for which the device was enabled.			
	14 = Analogue input 1 [%] Current value that is present at analogue input 1 of the device			
	15 = Analogue input 2 [%] Current value that is present at analogue input 2 of the device			
	16 = ... 18 <i>Reserved</i> , POSICON			
	19 = Heat sink temperature [°C] Current temperature of the heat sink			
	20 = Actual utilisation of motor [%] Average motor utilisation, based on the known motor data (P201...P209).			
	21 = Brake resistor utilisation [%] " <i>Braking resistor utilisation</i> " is the average braking resistor load, based on the known resistance data (P556...P557).			
	22 = Interior temperature [°C] Current interior temperature of device (<i>SK 54xE / SK 2xxE</i>)			
	23 = Motor temperature Measured via KTY-84			
	24 = ... 29 <i>Reserved</i>			
	30 = Present Target MP-S [Hz] " <i>Current motor potentiometer function setpoint with storage</i> ". (P420...=71/72). The nominal value can be read out with this function or pre-set (without the drive running).			
	31 = ... 39 <i>Reserved</i>			
	40 = PLC control box value Visualisation mode for PLC communication			
	41 = ... 59 <i>Reserved</i> , POSICON			
	60 = R stator ident Stator resistance determined by means of measurement (P220)			

61 =	R rotor ident	the rotor resistance determined by measurement ((P220) Function 2)
62 =	L stray stator ident	the stray inductance determined by measurement ((P220) Function 2)
63 =	L stator ident	the inductance determined by measurement ((P220) Function 2)
65 =		<i>Reserved</i>

P002	Display factor (<i>Display factor</i>)		S	
-------------	--	--	----------	--

0.01 ... 999.99
{ 1.00 }

The selected operating value in parameter P001 >Select of display< is multiplied with the scaling factor in P000 and displayed in >Operating parameter display<. It is therefore possible to display system-specific operating such as e.g. the throughput quantity

P003	Supervisor Code (<i>Supervisor Code</i>)			
-------------	--	--	--	--

0 ... 9999
{ 1 }

0 = The Supervisor parameters are **not** visible.
1 = All parameters are visible.
2 = Only the menu group 0 > Operating display< (P000 ... P003) is visible.
3 ... 9999, as for setting value 2.

 Information

Display via NORD CON

If parameterisation is carried out with the NORD CON software, the settings 2 ... 9999 the settings are as for the 0 setting.

Basic parameters

Parameter {factory setting}	Setting value / Description / Note		Supervisor	Parameter set
--------------------------------	------------------------------------	--	------------	---------------

P100	Parameter set (<i>Parameter set</i>)		S	
-------------	--	--	----------	--

0 ... 3
{ 0 }

Selection of the parameter sets to be parameterised. 4 parameter sets are available. The parameters to which different values can also be assigned in the 4 parameter sets are known as "parameter set-dependent" and are marked with a "P" in the header in the following descriptions. The operating parameter set is selected using appropriately parametrised digital inputs or by means of BUS actuation. If enabled via the keyboard (SimpleBox, ControlBox, PotentiometerBox or ParameterBox), the operating parameter set will match the settings in P100.

P101	Copy parameter set (<i>Copy parameter set</i>)		S	
-------------	--	--	----------	--

0 ... 4
{ 0 }

After confirmation with the OK / ENTER key, a copy of the parameter set selected in P100 >Parameter set< is written to the parameter set dependent on the value selected here

0 = Do not copy
1 = Copy actual to P1: Copies the active parameter set to parameter set 1
2 = Copy actual to P2: Copies the active parameter set to parameter set 2
3 = Copy actual to P3: Copies the active parameter set to parameter set 3
4 = Copy actual to P4: Copies the active parameter set to parameter set 4

P102	Acceleration time (Acceleration time)			P
0 ... 320.00 sec { 2.00 } { 5.00 } ≥ 45 kW	<p>The start-up time is the time corresponding to the linear frequency rise from 0 Hz to the set maximum frequency (P105). If an actual setpoint of <100 % is being used, the acceleration time is reduced linearly according to the setpoint which is set.</p> <p>The acceleration time can be extended by certain circumstances, e.g. FI overload, setpoint lag, smoothing, or if the current limit is reached.</p> <p>NOTE:</p> <p>Care must be taken that the parameter values are realistic. A setting of P102 = 0 is not permissible for drive units!</p> <p>Notes on ramp gradient:</p> <p>Amongst other things, the ramp gradient is governed by the inertia of the rotor. A ramp with a gradient which is too steep may result in the "inversion" of the motor.</p> <p>In general, extremely steep ramps (e.g.: 0 - 50 Hz in < 0.1 s) should be avoided, as may cause damage to the frequency inverter.</p>			
P103	Braking time (Braking time)			P
0 ... 320.00 sec { 2.00 } { 5.00 } ≥ 45 kW	<p>The braking time is the time corresponding to the linear frequency reduction from the set maximum frequency to 0 Hz (P105). If an actual setpoint <100 % is being used, the deceleration time reduces accordingly.</p> <p>The braking time can be extended by certain circumstances, e.g. by the selected >Switch-off mode< (P108) or >Ramp smoothing< (P106).</p> <p>NOTE:</p> <p>Care must be taken that the parameter values are realistic. A setting of P103 = 0 is not permissible for drive units!</p> <p>Notes concerning ramp steepness: see parameter (P102)</p>			
P104	Minimum frequency (Minimum frequency)			P
0.0 ... 400.0 Hz { 0.0 }	<p>The minimum frequency is the frequency supplied by the FI as soon as it is enabled and no additional setpoint is set.</p> <p>In combination with other setpoints (e.g. analog setpoint of fixed frequencies) these are added to the set minimum frequency.</p> <p>This frequency is undershot when</p> <ol style="list-style-type: none"> the drive is accelerated from standstill. The FI is blocked. The frequency then reduces to the absolute minimum (P505) before it is blocked. The FI reverses. The reverse in the rotation field takes place at the absolute minimum frequency (P505). <p>This frequency can be continuously undershot if, during acceleration or braking, the function "Maintain frequency" (Function Digital input = 9) is executed.</p>			

P105	Maximum frequency <i>(Maximum frequency)</i>			P
-------------	--	--	--	----------

0.1 ... 400.0 Hz
{ 50.0 }

The frequency supplied by the FI after being enabled and once the maximum setpoint is present, e.g. analogue setpoint as per P403, a correspondingly fixed frequency or maximum via the ControlBox.

This frequency can only be overshoot by the slip compensation (P212), the function "Maintain frequency" (function digital input = 9) or a change to another parameter set with lower maximum frequency.

Maximum frequencies are subject to certain restrictions, e.g.

- Restrictions in weak field operation,
- Compliance with mechanically permissible speeds,
- PMSM: Restriction of the maximum frequency to a value which is slightly above the rated frequency. This value is calculated from the motor data and the input voltage.

P106	Ramp smoothing <i>(Ramp smoothing)</i>			P
-------------	--	--	--	----------

0 ... 100 %
{ 0 }

This parameter enables a smoothing of the acceleration and deceleration ramps. This is necessary for applications where gentle, but dynamic speed change is important.

Ramp smoothing is carried out for every setpoint change.

The value to be set is based on the set acceleration and deceleration time, however values <10% have no effect.

The following then applies for the entire acceleration or deceleration time, including rounding:

$$t_{\text{tot ACCELERATION TIME}} = t_{P102} + t_{P102} \cdot \frac{P106 [\%]}{100\%}$$

$$t_{\text{tot DECELERATION TIME}} = t_{P103} + t_{P103} \cdot \frac{P106 [\%]}{100\%}$$

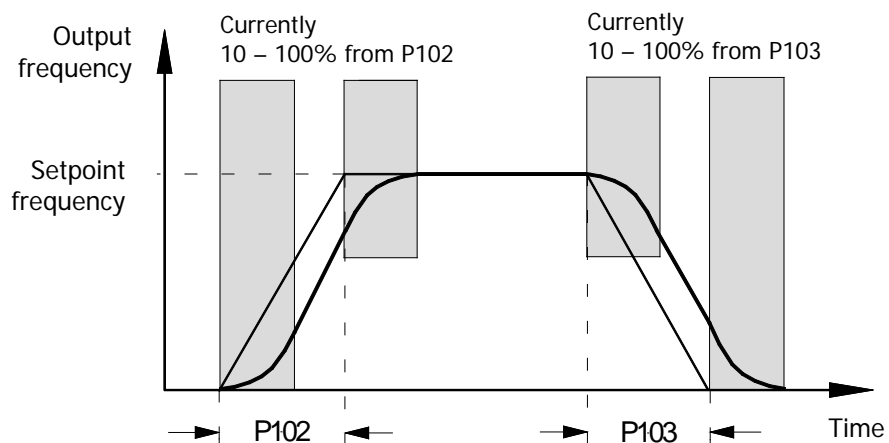

P107	Brake reaction time <i>(Brake reaction time)</i>			P
0 ... 2.50 s { 0.00 }	<p>Electromagnetic brakes have a physically-dependent delayed reaction time when actuated. This can cause a dropping of the load for lifting applications, as the brake only takes over the load after a delay.</p> <p>The reaction time must be taken into consideration by setting parameter P107.</p> <p>Within the adjustable application time, the FI supplies the set absolute minimum frequency (P505) and so prevents movement against the brake and load drop when stopping.</p> <p>If a time > 0 is set in P107 or P114, at the moment the FI is switched on, the level of the excitation current (field current) is checked. If no magnetising current is present, the FI remains in magnetising mode and the motor brake is not released.</p> <p>In order to achieve a shut-down and an error message (E016) in this case, P539 must be set to 2 or 3.</p> <p>See also the parameter >Release time< P114</p>			

i Information

Brake control

For the control of electromagnetic braking (especially for lifting equipment) an internal relay should be used, (Function 1, external brake (P434/441). The minimum absolute frequency (P505) should never be less than 2.0 Hz.

Recommendation for applications:

Lifting equipment with brake, without speed feedback Lifting equipment with brake

- P114 = 0.02...0.4 s *
- P107 = 0.02...0.4 s *
- P201...P208 = Motor data
- P434 = 1 (ext. brake)
- P505 = 2...4 Hz

for safe start-up

- P112 = 401 (off)
- P536 = 2.1 (off)
- P537 = 150 %
- P539 = 2/3 (I_{SD} monitoring)

to prevent load drops

- P214 = 50...100 % (precontrol)

* Settings (P107/114) depending on brake type and motor size. At low power levels (< 1.5 kW) lower values apply for higher power ratings (> 4.0 kW) are larger values.

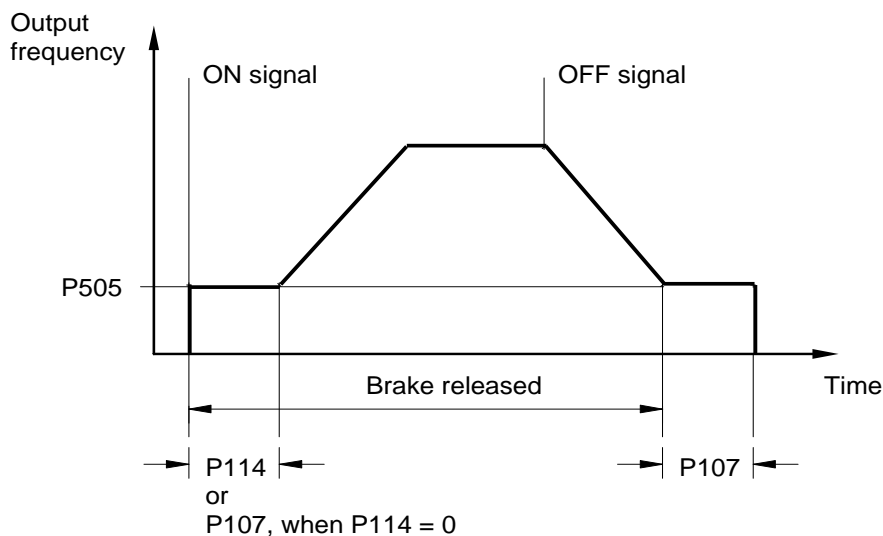

P108	Disconnection mode	S	P
0 ... 13 { 1 }	<i>(Disconnection mode)</i>		
	This parameter determines the manner in which the output frequency is reduced after "Blocking" (controller enable → Low).		
	0 = Block voltage: The output signal is switched off immediately. The FI no longer supplies an output frequency. The motor is only braked by mechanical friction. Switching the FI on again immediately can lead to an error message.		
	1 = Ramp: The current output frequency is reduced in proportion to the remaining deceleration time, from P103/P105. The DC run-on follows the end of the ramp (→ P559).		
	2 = Ramp with delay: as for 1 "Ramp", however for generational operation the brake ramp is extended, or for static operation the output frequency is increased. Under certain conditions, this function can prevent overload switch off or reduce brake resistance power dissipation.		
	NOTE: This function must not be programmed if defined deceleration is required, e.g. with lifting mechanisms.		
	3 = Immediate DC braking: The FI switches immediately to the preselected DC current (P109). This DC current is supplied for the remaining proportion of the >DC brake time< (P110). Depending on the relationship, actual output frequency to max. frequency (P105), the >Time DC brake on< is shortened. The time taken for the motor to stop depends on the application. The time taken to stop depends on the mass inertia of the load and the DC current set (P109). With this type of braking, no energy is returned to the FI; heat loss occurs mainly in the motor rotor.		
	Not for PMSM motors!		
	4 = Const. brake distance, "Constant brake distance": The brake ramp is delayed in starting if the equipment is <u>not</u> being driven at the maximum output frequency (P105). This results in an approximately similar braking distance for different frequencies.		
	NOTE: This function cannot be used as a positioning function. This function should not be combined with ramp smoothing (P106).		
	5 = Combined braking, "Combined braking": Dependent on the actual link voltage (UZV), a high frequency voltage is switched to the basic frequency (only for linear characteristic curves, P211 = 0 and P212 = 0). The braking time (P103) is complied with if possible. → Additional heating in the motor!		
	Not for PMSM motors!		
	6 = Quadratic ramp: The brake ramp does not follow a linear path, but rather a decreasing quadratic one.		
	7 = Quad. ramp with delay, "Quadratic ramp with delay": Combination of functions 2 and 6		
	8 = Quad. comb. braking, "Quadratic combined braking": Combination of functions 5 and 6		
	Not for PMSM motors!		
	9 = Const. acceln. power, "Constant acceleration power": Only applies in field weakening range! The drive is accelerated or braked using constant electrical power. The course of the ramps depends on the load.		
	10 = Distance calculator: Constant distance between actual frequency / speed and the set minimum output frequency (P104).		
	11 = Const. acceln. power with delay, "Constant acceleration power with delay": Combination of functions 2 and 9.		
	12 = Const. acceln. power mode 3, "Constant acceleration power mode 3" as for 11, however with additional relief of the brake chopper		
	13 = Disconnection delay, "Ramp with disconnection delay": as for 1 "Ramp", however, before the brake is applied, the drive unit remains at the absolute minimum frequency set in parameter (P505) for the time specified in parameter (P110). Application example: Re-positioning for crane control		

P109	DC brake current (DC brake current)		S	P
0 ... 250 % { 100 }	<p>Current setting for the functions of DC current braking (P108 = 3) and combined braking (P108 = 5).</p> <p>The correct setting value depends on the mechanical load and the required deceleration time. A higher setting brings large loads to a standstill more quickly.</p> <p>The 100% setting relates to a current value as stored in the >Nominal current< parameter P203.</p> <p>NOTE: The amount of DC current (0 Hz) which the FI can supply is limited. For this value, please refer to the table in Section (chapter 8.4.3), column: 0 Hz. In the basic setting this limiting value is about 110 %.</p> <p>DC braking Not for PMSM motors!</p>			
P110	Time DC-brake on (DC braking time on)		S	P
0.00 ... 60.00 sec { 2.00 }	<p>The time during which current selected in parameter P109 is applied to the motor for the function "DC braking" selected in parameter P108 (P108 = 3).</p> <p>Depending on the relationship of the actual output frequency to the max. frequency (P105), the >DC brake time< is shortened.</p> <p>The time starts running with the removal of the enable and can be interrupted by fresh enabling.</p> <p>DC braking Not for PMSM motors!</p>			
P111	P factor torque limit (P factor torque limit)		S	P
25 ... 400 % { 100 }	<p>Directly affects the behaviour of the drive at torque limit. The basic setting of 100% is sufficient for most drive tasks.</p> <p>If values are too high the drive tends to vibrate as it reaches the torque limit. If values are too low, the programmed torque limit can be exceeded.</p>			
P112	Torque current limit (Torque current limit)		S	P
25 ... 400 % / 401 { 401 }	<p>With this parameter, a limit value for the torque-generating current can be set. This can prevent mechanical overloading of the drive. It cannot provide any protection against mechanical blockages (movement to stops). A slipping clutch which acts as a safety device must be provided.</p> <p>The torque current limit can also be set over an infinite range of settings using an analog input. The maximum setpoint (compare adjustment 100%, P403/P408) then corresponds to the value set in P112.</p> <p>The limit value 20% of current torque cannot be undershot by a smaller analog setpoint (P400/405 = 2). However, in servo mode with P300 = 1:</p> <ul style="list-style-type: none"> • up to SW version 1.9: not less than 10% • SW version 2.0 and above: no restriction (motor torques from 0% are possible)! <p>401 = OFF means the switch-off of the torque current limit! This is also the basic setting for the FI.</p> <p>NOTE: For lifting gear applications, a torque limit must not be used!</p>			

P113	Jog frequency <i>(Jog frequency)</i>		S	P
-400.0 ... 400.0 Hz { 0.0 }	When using the ControlBox or ParameterBox to control the FI, the jog frequency is the initial value following successful enabling. Alternatively, when control is via the control terminals, the jog frequency can be activated via one of the digital inputs. The setting of the jog frequency can be done directly via this parameter or, if the FI is enabled via the keyboard, by pressing the ENTER key. In this case, the actual output frequency is set in parameter P113 and is then available for the next start.			
<i>Change of function as of software version 1.7</i>	NOTE: Software version V1.7 R0 and higher: The activation of the jog frequency via one of the digital inputs causes the remote control to be switched off in case of bus operation. In addition, any setpoint frequencies present are not taken into account. Exception: analog setpoint values which are processed via the functions Frequency addition or Frequency subtraction. Up to software version V1.6 R1: Specified setpoints via the control terminals, e.g. jog frequency, fixed frequencies or analog setpoints, are generally added with the correct sign. The set maximum frequency (P105) cannot be exceeded and the minimum frequency (P104) cannot be undershot.			
P114	Brake delay off <i>(Brake release time)</i>		S	P
0 ... 2.50 s { 0.00 }	Electromagnetic brakes have a delayed reaction time during ventilation, which depends on physical factors. This can lead to the motor running while the brake is still applied, which will cause the inverter to switch off with an overcurrent report. This release time can be taken into account in parameter P114 (Brake control). During the adjustable ventilation time, the FI supplies the set absolute minimum frequency (P505) thus preventing movement against the brake. See also the parameter >Brake reaction time< P107 (setting example).			
	NOTE: If the brake ventilation time is set to "0", then P107 is the brake ventilation and reaction time.			

Motor data / Characteristic curve parameters

Parameter {factory setting}	Setting value / Description / Note		Supervisor	Parameter set
P200	Motor list <i>(Motor list)</i>			P
0 ... 73 { 0 }	The factory settings for the motor data can be changed with this parameter. The factory setting in parameters P201...P209 is a 4-pole IE1 - DS standard motor with the nominal FI power setting. By selecting one of the possible digits and pressing the ENTER key, all motor parameters (P201...P209) are adjusted to the selected standard power. The basis for the motor data is a 4-pole DS standard motor The basis for the motor data is a 4-pole DS standard motor The motor data for NORD IE4 motors can be found in the final section of the list.			
	NOTE: As P200 returns to = 0 after the input confirmation, the control of the set motor can be implemented via parameter P205.			

i Information
IE2/IE3 Motors

If IE2/IE3 motors are used, after selecting an IE1 motor (P200) the motor data in P201 to P209 must be adapted to the data on the motor type plate.

0 = No change

1 = No motor: In this setting, the FI operates without current control, slip compensation and pre-magnetising time, and is therefore not recommended for motor applications. Possible applications are induction furnaces or other applications with coils and transformers. The following motor data is set here: 50.0 Hz / 1500 rpm / 15.0 A / 400 V / 0.00 kW / cos φ =0.90 / Stern / R_s 0.01 Ω / I_{LEER} 6.5 A

2 = 0.25kW 230V	32 = 4.0 kW 230V	62 = 90.0 kW 400V	92 = 1.00kW 115V
3 = 0.33PS 230V	33 = 5.0 PS 230V	63 = 120.0 PS 460V	93 = 4.0 PS 230V
4 = 0.25kW 400V	34 = 4.0 kW 400V	64 = 110.0 kW 400V	94 = 4.0 PS 460V
5 = 0.33PS 460V	35 = 5.0 PS 460V	65 = 150.0 PS 460V	95 = 0.75kW 230V 80T1/4
6 = 0.37kW 230V	36 = 5.5 kW 230V	66 = 132.0 kW 400V	96 = 1.10kW 230V 90T1/4
7 = 0.50PS 230V	37 = 7.5 PS 230V	67 = 180.0 PS 460V	97 = 1.10kW 230V 80T1/4
8 = 0.37kW 400V	38 = 5.5 kW 400V	68 = 160.0 kW 400V	98 = 1.10kW 400V 80T1/4
9 = 0.50PS 460V	39 = 7.5 PS 460V	69 = 220.0 PS 460V	99 = 1.50kW 230V 90T3/4
10 = 0.55kW 230V	40 = 7.5 kW 230V	70 = 200.0 kW 400V	100 = 1.50kW 230V 90T1/4
11 = 0.75PS 230V	41 = 10.0 PS 230V	71 = 270.0 PS 460V	101 = 1.50kW 400V 90T1/4
12 = 0.55kW 400V	42 = 7.5 kW 400V	72 = 250.0 kW 400V	102 = 1.50kW 400V 80T1/4
13 = 0.75PS 460V	43 = 10.0 PS 460V	73 = 340.0 PS 460V	103 = 2.20kW 230V 100T2/4
14 = 0.75kW 230V	44 = 11.0 kW 400V	74 = 11.0 kW 230V	104 = 2.20kW 230V 90T3/4
15 = 1.0 PS 230V	45 = 15.0 PS 460V	75 = 15.0 PS 230V	105 = 2.20kW 400V 90T3/4
16 = 0.75kW 400V	46 = 15.0 kW 400V	76 = 15.0 kW 230V	106 = 2.20kW 400V 90T1/4
17 = 1.0 PS 460V	47 = 20.0 PS 460V	77 = 20.0 PS 230V	107 = 3.00kW 230V 100T5/4
18 = 1.1 kW 230V	48 = 18.5 kW 400V	78 = 18.5 kW 230V	108 = 3.00kW 230V 100T2/4
19 = 1.5 PS 230V	49 = 25.0 PS 460V	79 = 25.0 PS 230V	109 = 3.00kW 400V 100T2/4
20 = 1.1 kW 400V	50 = 22.0 kW 400V	80 = 22.0 kW 230V	110 = 3.00kW 400V 90T3/4
21 = 1.5 PS 460V	51 = 30.0 PS 460V	81 = 30.0 PS 230V	111 = 4.00kW 230V 100T5/4
22 = 1.5 kW 230V	52 = 30.0 kW 400V	82 = 30.0 kW 230V	112 = 4.00kW 400V 100T5/4
23 = 2.0 PS 230V	53 = 40.0 PS 460V	83 = 40.0 PS 230V	113 = 4.00kW 400V 100T2/4
24 = 1.5 kW 400V	54 = 37.0 kW 400V	84 = 37.0 kW 230V	114 = 5.50kW 400V 100T5/4
25 = 2.0 PS 460V	55 = 50.0 PS 460V	85 = 50.0 PS 230V	115 =
26 = 2.2 kW 230V	56 = 45.0 kW 400V	86 = 0.12kW 115V	116 =
27 = 3.0 PS 230V	57 = 60.0 PS 460V	87 = 0.18kW 115V	117 =
28 = 2.2 kW 400V	58 = 55.0 kW 400V	88 = 0.25kW 115V	118 =
29 = 3.0 PS 460V	59 = 75.0 PS 460V	89 = 0.37kW 115V	119 =
30 = 3.0 kW 230V	60 = 75.0 kW 400V	90 = 0.55kW 115V	120 =
31 = 3.0 kW 400V	61 = 100.0 PS 460V	91 = 0.75kW 115V	121 =

P201	Nominal motor frequency (Nominal motor frequency)		S	P
10.0 ... 399.9 Hz { see information }	The motor nominal frequency determines the V/f break point at which the FI supplies the nominal voltage (P204) at the output.			

i Information
Default setting

The default setting is dependent upon the FI nominal power and the setting in P200.

P202	Nominal motor speed (Nominal motor speed)		S	P
150 ... 24000 rpm { see information }	The nominal motor speed is important for the correct calculation and control of the motor slip and the speed display (P001 = 1).			

i Information
Default setting

The default setting is dependent upon the FI nominal power and the setting in P200.

P203	Nominal motor current (Nominal motor current)		S	P
0.1 ... 1000.0 A { see information }	The nominal motor current is a decisive parameter for the current vector control.			
	i Information	Default setting		
	The default setting is dependent upon the FI nominal power and the setting in P200.			
P204	Nominal motor voltage (Nominal motor voltage)		S	P
100 ... 800 V { see information }	The >Nominal voltage< matches the mains voltage to the motor voltage. In combination with the nominal frequency, the voltage/frequency characteristic curve is produced.			
	i Information	Default setting		
	The default setting is dependent upon the FI nominal power and the setting in P200.			
P205	Nominal motor power (Nominal motor power)			P
0.00 ... 250.00 kW { see information }	The motor nominal power controls the motor set via P200.			
	i Information	Default setting		
	The default setting is dependent upon the FI nominal power and the setting in P200.			
P206	Motor cos phi (Motor cos φ)		S	P
0.50 ... 0.95 { see information }	The motor cos φ is a decisive parameter for the current vector control.			
	i Information	Default setting		
	The default setting is dependent upon the FI nominal power and the setting in P200.			
P207	Motor circuit (Motor circuit)		S	P
0 ... 1 { see information }	0 = star 1 = delta			
	The motor circuit is decisive for stator resistance measurement (P220) and therefore for current vector control.			
	i Information	Default setting		
	The default setting is dependent upon the FI nominal power and the setting in P200.			
P208	Stator resistance (Stator resistance)		S	P
0.00 ... 300.00 W { see information }	Motor stator resistance \Rightarrow resistance of a <u>phase winding</u> with a DC motor.			
	Has a direct influence on the current control of the FI. Too high a value will lead to a possible overcurrent; too low a value to a motor torque that is too low.			
	The parameter P220 can be used for simple measurement. Parameter P208 can be used for manual setting or as information about the result of an automatic measurement.			
	NOTE:			
	For optimum functioning of the current vector control, the stator resistance must be automatically measured by the FI.			
	i Information	Default setting		
	The default setting is dependent upon the FI nominal power and the setting in P200.			

P209	No load current (No load current)		S	P
0.0 ... 1000.0 A { see information }	This value is always calculated automatically from the motor data if there is a change in the parameter >cos φ< P206 and the parameter >Nominal current< P203. NOTE: If the value is to be entered directly, then it must be set as the last motor data. This is the only way to ensure that the value will not be overwritten.			
i Information		Default setting		
The default setting is dependent upon the FI nominal power and the setting in P200.				
P210	Static boost (Static boost)		S	P
0 ... 400 % { 100 }	The static boost affects the current that generates the magnetic field. This is equivalent to the no load current of the respective motor and is therefore <u>load-independent</u> . The no load current is calculated using the motor data. The factory setting of 100% is sufficient for normal applications.			
P211	Dynamic boost (Dynamic boost)		S	P
0 ... 150 % { 100 }	The dynamic boost affects the torque generating current and is therefore a load-dependent parameter. The factory 100% setting is also sufficient for typical applications. Too high a value can lead to overcurrent in the FI. Under load therefore, the output voltage will be raised too sharply. Too low a value will lead to insufficient torque.			
P212	Slip compensation (Slip compensation)		S	P
0 ... 150% { 100 }	The slip compensation increases the output frequency, dependent on load, to keep the asynchronous motor speed approximately constant. The factory setting of 100% is optimal when using DC asynchronous motors and correct motor data has been set. If several motors (different loads or outputs) are operated with one FI, the slip compensation P212 must be set to 0%. This excludes any negative influences. With PMSM motors, the parameter must be left at the factory setting.			
P213	ISD ctrl. loop gain (Amplification of ISD control)		S	P
25 ... 400 % { 100 }	This parameter influences the control dynamics of the FI current vector control (ISD control). Higher settings make the controller faster, lower settings slower. Dependent on application type, this parameter can be altered, e.g. to avoid unstable operation.			
P214	Torque precontrol (Torque precontrol)		S	P
-200 ... 200 % { 0 }	This function allows a value for the expected torque requirement to be set in the controller. This function can be used in lifting applications for a better load transfer during start-up. NOTE: Motor torques (with rotation field right) are entered with a positive sign, generator torques are entered with a negative sign. The reverse applies for the counter clockwise rotation.			

P215	Boost precontrol <i>(Boost precontrol)</i>		S	P
0 ... 200 % { 0 }	<p>Only advisable with linear characteristic curve (P211 = 0% and P212 = 0%).</p> <p>For drives that require a high starting torque, this parameter provides an option for switching in an additional current during the start phase. The application time is limited and can be selected at parameter >Time boost precontrol< P216.</p> <p>All current and torque current limits that may have been set (P112 and P536, P537) are deactivated during the boost lead time.</p> <p>NOTE:</p> <p>With active ISD control (P211 and / or P212 ≠ 0%), parameterisation of P215 ≠ 0 results in incorrect control.</p>			
P216	Time boost precontrol <i>(Time boost precontrol)</i>		S	P
0.0 ... 10.0 sec { 0.0 }	<p>This parameter is used for 3 functionalities</p> <p>Time limit for the boost lead: Application time for increased starting current. Only with linear characteristic curve (P211 = 0% and P212 = 0%).</p> <p>Time limit for suppression of pulse switch-off (P537): enables start-up under heavy load.</p> <p>Time limit for suppression of switch-off on error in parameter (P401), setting { 05 } "0 - 10V with switch-off on error 2"</p>			
P217	Oscillation damping <i>(Oscillation damping)</i>		S	P
0 ... 400 % { 10 }	<p>With the oscillation damping, idling current harmonics can be damped. Parameter 217 is a measure of the damping power.</p> <p>For oscillation damping the oscillation component is filtered out of the torque current by means of a high pass filter. This is amplified by P217, inverted and switched to the output frequency.</p> <p>The limit for the value switched is also proportional to P217. The time constant for the high pass filter depends on P213. For higher values of P213 the time constant is lower.</p> <p>With a set value of 10 % for P217, a maximum of ± 0.045 Hz are switched in. At 400 % in P217, this corresponds to ± 1.8 Hz</p> <p>The function is not active in "Servo mode, P300".</p>			
P218	Modulation depth <i>(Modulation depth)</i>		S	
50 ... 110 % { 100 }e	<p>This setting influences the maximum possible output voltage of the FI in relation to the mains voltage. Values <100% reduce the voltage to values below that of the mains voltage if this is required for motors. Values >100% increase the output voltage to the motor increased the harmonics in the current, which may cause swinging in some motors.</p> <p>Normally, 100% should be set.</p>			

P219	Automatic flux optimisation (Automatic flux optimisation)		S	
25 ... 100 % / 101 { 100 }	<p>With this parameter, the magnetic flux of the motor can be automatically matched to the motor load, so that the energy consumption is reduced to the amount which is actually required. P219 is a limiting value, to which the field in the motor can be reduced.</p> <p>As standard, the value is set to 100%, and therefore no reduction is possible. As minimum, 25% can be set.</p> <p>The reduction of the field is performed with a time constant of approx. 7.5 sec. On increase of load the field is built up again with a time constant of approx. 300 ms. The reduction of the field is carried out so that the magnetisation current and the torque current are approximately equal, so that the motor is operated with "optimum efficiency". An increase of the field above the setpoint value is not intended.</p> <p>This function is intended for applications in which the required torque only changes slowly (e.g. pumps and fans). Its effect therefore replaces a quadratic curve, as it adapts the voltage to the load.</p> <p>This parameter does not function for the operation of synchronous motors (IE4 motors).</p> <p>NOTE: This must not be used for lifting or applications where a more rapid build-up of the torque is required, as otherwise there would be overcurrent switch-offs or inversion of the motor on sudden changes of load, because the missing field would have to be compensated by a disproportionate torque current.</p> <p>101 = automatic, with the setting P219=101 an automatic magnetisation current controller is activated. The ISD controller then operates with a subordinate magnetizing controller, which improves the slippage calculation, especially at higher loads. The control times are considerably faster compared to the Normal ISD control (P219 = 100)</p>			

P2xx Control/characteristic curve parameters

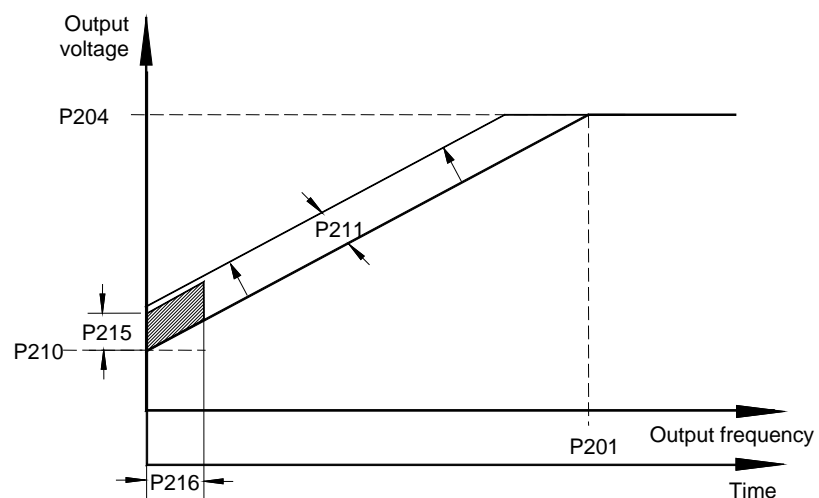

NOTE:
"typical"

Settings for the...

Current vector control (factory setting)

P201 to P209 = Motor data
 P210 = 100%
 P211 = 100%
 P212 = 100%
 P213 = 100%
 P214 = 0%
 P215 = no significance
 P216 = no significance

Linear V/f characteristic curve

P201 to P209 = Motor data
 P210 = 100% (static boost)
 P211 = 0%
 P212 = 0%
 P213 = no significance
 P214 = no significance
 P215 = 0% (boost precontrol)
 P216 = 0s (time dyn. boost)

P220	Para. identification (Parameter identification)			P
0 ... 2 { 0 }	<p>With devices with output of 7.5 kW, the motor data is determined automatically by the device via these parameters. In many cases, better drive behaviour is achieved with the measured motor data.</p> <p>The identification of all parameters takes some time. Do not switch off the mains voltage during this time. If unfavourable operating behaviour takes place after identification, select a suitable motor in P200 or set parameters P201 ... P208 manually.</p> <p>0 = No identification 1 = Identification R_s: The stator resistance (display in P208) is determined by multiple measurements.</p> <p>2 = Motor identification: This function can only be used with devices up to 7.5 kW (230 V to 4.0 kW). ASM: all motor parameters (P202, P203, P206, P208, P209) are determined. PMSM: the stator resistance (P208) and the inductance (P241) are determined</p> <p>NB: Motor identification should only be carried out on a cold motor (15 ... 25°C) Warming up of the motor during operation is taken into account.</p> <p>The FI must be in "Ready for operation" condition. For BUS operation, the BUS must be operating without error.</p> <p>The motor power may only be one power level greater or 3 power levels lower than the nominal power of the FI.</p> <p>A maximum motor cable length of 20m must be adhered to for reliable identification.</p> <p>Before starting motor identification, the motor data must be preset in accordance with the rating plate or P200. At least the nominal frequency (P201), the nominal speed (P202), the voltage (P204), the power (P205) and the motor circuit (P207) must be known.</p> <p>Care must be taken that the connection to the motor is not interrupted during the entire measuring process.</p> <p>If the identification cannot be concluded successfully, the error message E019 is generated.</p> <p>After identification of parameters, P220 is again = 0.</p>			

P240	EMF voltage PMSM (EMF voltage PMSM)		S	P						
0 ... 800 V { 0 }	<p>The EMF constant describes the self induction voltage of the motor. The value to be set can be found on the data sheet for the motor or on the type plate and is scaled to 1000 rpm. As the rated speed of the motor is not usually 1000 rpm, these details must be converted accordingly:</p> <p>Example:</p> <table data-bbox="435 1518 1506 1713"> <tr> <td>E (EMF - constant, type plate):</td> <td>89 V</td> </tr> <tr> <td>Nn (rated speed of motor):</td> <td>2100 rpm</td> </tr> <tr> <td>Value in P240</td> <td> $P240 = E \cdot Nn / 1000$ $P240 = 89 \text{ V} \cdot 2100 \text{ rpm} / 1000 \text{ rpm}$ P240 = 187 V </td> </tr> </table> <p>0 = ASM is used, "Asynchronous machine is used": No compensation</p>	E (EMF - constant, type plate):	89 V	Nn (rated speed of motor):	2100 rpm	Value in P240	$P240 = E \cdot Nn / 1000$ $P240 = 89 \text{ V} \cdot 2100 \text{ rpm} / 1000 \text{ rpm}$ P240 = 187 V			
E (EMF - constant, type plate):	89 V									
Nn (rated speed of motor):	2100 rpm									
Value in P240	$P240 = E \cdot Nn / 1000$ $P240 = 89 \text{ V} \cdot 2100 \text{ rpm} / 1000 \text{ rpm}$ P240 = 187 V									

Control parameters

Only available above SK 520E with the use of an incremental encoder.

Parameter {factory setting}	Setting value / Description / Note		Supervisor	Parameter set																		
P300	Servo Mode (<i>Servo Mode</i>)			P																		
0 ... 2 { 0 }	<p>The control method for the motor is defined with this parameter. The following constraints must be observed: In comparison with the setting "0", the setting "2" enables somewhat higher dynamics and control precision, however it requires greater effort for parameterisation. In contrast, the setting "1" operates with speed feedback from an encoder and therefore enables the highest possible quality of speed control and dynamics.</p> <p>0 = Off (VFC open -loop) 1 Speed control without encoder feedback 1 = On (CFC closed-loop) 2) Speed control with encoder feedback 2 = Obs (CFC open-loop) Speed control without encoder feedback</p> <p>NOTE: Commissioning information (📖 Abschnitt 4.2 "Selecting the operating mode for motor control").</p> <p>1) Corresponds to the previous setting "OFF" 2) Corresponds to the previous setting "ON"</p>																					
P301	Rotary encoder res. (<i>Rotary encoder resolution</i>)																					
0 ... 17 { 6 }	<p>Input of the pulse-count per rotation of the connected encoder.</p> <p>If the encoder rotation direction is not the same as the FI, (depending on installation and wiring), this can be compensated for by selecting the corresponding negative pulse numbers 8...16.</p> <table border="0"> <tr> <td>0 = 500 pulses</td> <td>8 = -500 pulses</td> </tr> <tr> <td>1 = 512 pulses</td> <td>9 = -512 pulses</td> </tr> <tr> <td>2 = 1000 pulses</td> <td>10 = -1000 pulses</td> </tr> <tr> <td>3 = 1024 pulses</td> <td>11 = -1024 pulses</td> </tr> <tr> <td>4 = 2000 pulses</td> <td>12 = -2000 pulses</td> </tr> <tr> <td>5 = 2048 pulses</td> <td>13 = -2048 pulses</td> </tr> <tr> <td>6 = 4096 pulses</td> <td>14 = -4096 pulses</td> </tr> <tr> <td>7 = 5000 pulses</td> <td>15 = -5000 pulses</td> </tr> <tr> <td>17 = 8192 pulses</td> <td>16 = -8192 pulses</td> </tr> </table> <p>NOTE: (P301) is also significant for position control via incremental encoders. If an incremental encoder is used for positioning (P604=1), the setting of the pulse number is made here. (Please refer to POSICON Supplementary Manual)</p>	0 = 500 pulses	8 = -500 pulses	1 = 512 pulses	9 = -512 pulses	2 = 1000 pulses	10 = -1000 pulses	3 = 1024 pulses	11 = -1024 pulses	4 = 2000 pulses	12 = -2000 pulses	5 = 2048 pulses	13 = -2048 pulses	6 = 4096 pulses	14 = -4096 pulses	7 = 5000 pulses	15 = -5000 pulses	17 = 8192 pulses	16 = -8192 pulses			
0 = 500 pulses	8 = -500 pulses																					
1 = 512 pulses	9 = -512 pulses																					
2 = 1000 pulses	10 = -1000 pulses																					
3 = 1024 pulses	11 = -1024 pulses																					
4 = 2000 pulses	12 = -2000 pulses																					
5 = 2048 pulses	13 = -2048 pulses																					
6 = 4096 pulses	14 = -4096 pulses																					
7 = 5000 pulses	15 = -5000 pulses																					
17 = 8192 pulses	16 = -8192 pulses																					
P310	Speed controller P (<i>Speed controller P</i>)			P																		
0 ... 3200 % { 100 }	<p>P-component of the speed encoder (proportional amplification).</p> <p>Amplification factor, by which the speed difference between the setpoint and actual frequency is multiplied. A value of 100% means that a speed difference of 10% produces a setpoint of 10%. Values that are too high can cause the output speed to oscillate.</p>																					

P311	Speed controller I (Speed controller I)			P
0 ... 800 % / ms { 20 }	<p>I-component of the encoder (Integration component).</p> <p>The integration component of the controller enables the complete elimination of any control deviation. The value indicates how large the setpoint change is per ms. Values that are too small cause the controller to slow down (reset time is too long).</p>			
P312	Torque current controller P (Torque current controller P)		S	P
0 ... 1000 % { 400 }	<p>Current controller for the torque current. The higher the current controller parameters are set, the more precisely the current setpoint is maintained. Excessively high values in P312 generally lead to high-frequency oscillations at low speeds; on the other hand, excessively high values in P313 generally produce low frequency oscillations across the whole speed range.</p> <p>If the value "Zero" is entered in P312 and P313, then the torque current control is switched off. In this case, only the motor model pre-control is used.</p>			
P313	Torque current controller I (Torque current controller I)		S	P
0 ... 800 % / ms { 50 }	<p>I-proportion of the torque current controller. (See also P312 >Torque current controller P<)</p>			
P314	Torque current controller limit (Torque current controller limit)		S	P
0 ... 400 V { 400 }	<p>Determines the maximum voltage increase of the torque current controller. The higher the value, the greater the maximum effect that can be exercised by the torque current controller. Excessive values in P314 can specifically lead to instability during transition to the field weakening zone (see P320). The values for P314 and P317 should always be set roughly the same, so that the field and torque current controllers are balanced.</p>			
P315	Field current controller P (Field current controller P)		S	P
0 ... 1000 % { 400 }	<p>Current controller for the field current. The higher the current controller parameters are set, the more precisely the current setpoint is maintained. Excessively high values for P315 generally lead to high frequency vibrations at low speeds. On the other hand, excessively high values in P316 generally produce low frequency vibrations across the whole speed range. If the value "Zero" is entered in P315 and P316, then the field current controller is switched off. In this case, only the motor model pre-control is used.</p>			
P316	Field current controller I (Field current controller I)		S	P
0 ... 800 % / ms { 50 }	<p>I-proportion of the field current controller. See also P315 >Field current controller P<</p>			
P317	Field current controller limit (Field current controller limit)		S	P
0 ... 400 V { 400 }	<p>Determines the maximum voltage increase of the field current controller. The higher the value, the greater is the maximum effect that can be exercised by the field current controller. Excessive values in P317 can specifically lead to instability during transition to the field reduction range (see P320). The values for P314 and P317 should always be set roughly the same, so that the field and torque current controllers are balanced.</p>			

P318	Field weakening controller P (Field weakening controller P)		S	P
0 ... 800 % { 150 }	The field weakening controller reduces the field setpoint when the synchronous speed is exceeded. Generally, the field weakening controller has no function; for this reason, the field weakening controller only needs to be set if speeds are set above the nominal motor speed. Excessive values for P318 / P319 will lead to controller oscillations. The field is not weakened sufficiently if the values are too small or during dynamic acceleration and/or delay times. The downstream current controller can no longer read the current setpoint.			
P319	Field weakening controller I (Field weakening controller I)		S	P
0 ... 800 % / ms { 20 }	Only affects the field weakening range, see P318 >Field weakening controller P<			
P320	Field weakening limit (Field weakening limit)		S	P
0 ... 110 % { 100 }	The field weakening limit determines at which speed / current the controller will begin to weaken the field. At a set value of 100% the controller will begin to weaken the field at approximately the synchronous speed. If values much larger than the standard values have been set in P314 and/or P317, then the field weakening limit should be correspondingly reduced, so that the control range is actually available to the current controller.			
P321	Speedctr. I brake off (Speed control I brake release time)		S	P
0 ... 4 { 0 }	During the brake release time (P107/P114), the I component of the speed control is increased. This leads to better load take-up, especially with vertical movements. 0 = P311 speed control I x 1 1 = P311 speed control I x 2 2 = P311 speed control I x 4 3 = P311 speed control I x 8 4 = P311 speed control I x 16			
P325	Rotary encoder function (Rotary encoder function)			
0 ... 4 { 0 }	The actual speed list value supplied by an incremental encoder to the FI can be used for various functions in the FI. 0 = Speed measurement Servo mode, "Servo mode speed measurement" : The actual motor speed list value is used for the FI servo mode. The ISD control cannot be switched off in this function. 1 = PID actual frequency value : The actual speed of a system is used for speed control. This function can also be used for controlling a motor with a linear characteristic curve. It is also possible to use an incremental encoder for speed control which is not mounted directly onto the motor. P413 – P416 determine the control. 2 = Frequency addition : The determined speed is added to the actual setpoint value. 3 = Frequency subtraction : The determined speed is subtracted from the actual setpoint. 4 = Maximum frequency : The maximum possible output frequency / speed is limited by the speed of the encoder.			
P326	Ratio encoder (Encoder transformation ratio)			
0.01 ... 100.00 { 1.00 }	If the incremental encoder is not mounted directly onto the motor shaft, then the respectively correct transformation ratio of motor speed to encoder speed must be set. $P326 = \frac{\text{Motor speed}}{\text{Encoder speed}}$ Only when P325 = 1, 2, 3 or 4, therefore not in Servo mode (motor speed control)			

P327	Speed slip error (Speed slip error, speed control)																
0 ... 3000 rpm { 0 }	The limit value for a permitted maximum slip error can be set. If this value is reached, the FI switches off and indicates error E013.1. The slip error monitoring functions both with active and inactive servo mode (P300). 0 = OFF, Relevant settings																
	<table border="1"> <thead> <tr> <th>Encoder type</th> <th>Electrical connection</th> <th>Parameter</th> </tr> </thead> <tbody> <tr> <td>TTL encoder</td> <td>Encoder interface (Terminals X6)</td> <td>P325 = 0</td> </tr> <tr> <td rowspan="3">HTL encoder</td> <td>DIN2 (Terminal X5:22)</td> <td>...</td> </tr> <tr> <td>DIN5 (Terminal X5:24)</td> <td>...</td> </tr> <tr> <td></td> <td>P420 [-02] or P421 = 43 P420 [-04] or. P423 = 44 P461 = 0</td> </tr> </tbody> </table>	Encoder type	Electrical connection	Parameter	TTL encoder	Encoder interface (Terminals X6)	P325 = 0	HTL encoder	DIN2 (Terminal X5:22)	...	DIN5 (Terminal X5:24)	...		P420 [-02] or P421 = 43 P420 [-04] or. P423 = 44 P461 = 0			
Encoder type	Electrical connection	Parameter															
TTL encoder	Encoder interface (Terminals X6)	P325 = 0															
HTL encoder	DIN2 (Terminal X5:22)	...															
	DIN5 (Terminal X5:24)	...															
		P420 [-02] or P421 = 43 P420 [-04] or. P423 = 44 P461 = 0															
P328	Speed slip delay (Speed slip error delay)																
0.0 ... 10.0 sec { 0.0 } above SW 2.0	If the permissible speed slip error defined in (P327) is exceeded the error message E013.1 is suppressed within the time limits which are set here. 0.0 = OFF																
P330	Regulation PMSM (Regulation PMSM)		S														
0 ... 3 { 0 }	Determination of the regulation of PMSM (Permanent Magnet Synchronous Motors) at speed $n < n_{\text{SWITZOVER}}$ (See P331). 0 = Voltage controlled: With the first start of the machine, a voltage indicator is memorised which ensures that the rotor of the machine is set to the rotor position "zero". This type of starting position of the rotor can only be used if there is no counter-torque from the machine (e.g. flywheel drive) at frequency "zero". If this condition is fulfilled, this method of determining the position of the rotor is very precise ($<1^\circ$ electrical). In principle, this method is not suitable for lifting equipment, as there is always a counter-torque. <i>For operation without encoders, the following applies:</i> Up to the switch over frequency P331 the motor (with the nominal current memorised) is driven under voltage control. Once the switch over frequency has been reached, the method of determining the rotor position is switched over to the EMF method. If, taking hysteresis (P332) into account, the frequency falls below the value in (P331), the frequency inverter switches back from the EMF method to voltage controlled operation. 1 = Test signal method: The starting position of the rotor is determined with a test signal. This method also functions at a standstill with the brake applied, however it requires a PMSM with sufficient anisotropy between the inductivity of the d and q axes. The higher this anisotropy is, the greater the precision of the method. By means of parameter (P212) the voltage level of the test signal can be adjusted and with parameter (P213) the position of the motor position control can be adjusted. For motors which are suitable for use with the test signal method, a rotor position accuracy of $5^\circ \dots 10^\circ$ electrical can be achieved (depending on the motor and the anisotropy). 2 = reserved 3 = Value from CANopen encoder, "Value from CANopen encoder": As for "2", however a CANopen absolute encoder is used to determine the starting position of the rotor.																
P331	Switch over freq. PMSM (Switch over frequency PMSM)		S	P													
5.0 ... 100.0 % { 15.0 }	Definition of the frequency up to which in operation without encoder the control method of a PMSM (Permanent Magnet Synchronous Motor) is activated according to (P330). In this case, 100 % corresponds to the nominal motor frequency from (P201).																

P332	Hyst. Switchover PMSM (<i>Switchover frequency hysteresis PMSM</i>)		S	P
0.1 ... 25.0 % { 5.0 }	Difference between the switch-on and switch-off point in order to prevent oscillation on the transition of operation without encoder into the control method specified in (P330) (and vice versa).			
P333	Flux feedb. fact. PMSM (<i>Flux feedback factor PMSM</i>)		S	P
5 ... 400 % { 25 }	This parameter is necessary for the position monitor in CFC open-loop mode. The higher the value which is selected, the lower the slip error from the rotor position monitor. However, higher values also limit the lower limit frequency of the position monitor. The larger the feedback amplification which is selected, the higher the limit frequency and the higher the values which must be set in (P331) and (P332). This conflict of objectives can therefore not be resolved simultaneously for both optimisation objectives. The default value is selected so that it typically does not need to be adjusted for NORD IE4 motors.			
P334	Encoder offset PMSM (<i>Encoder offset PMSM</i>)		S	
-0,500 ... 0,500 rev { 0,000 }	Evaluation of the zero track is necessary for the operation of PMSM (Permanent Magnet Synchronous Motors). The zero impulse is then used for synchronisation of the rotor position. Parameter (P330) must be set to "0" or "1". The value to be set for parameter (P334) (offset between zero pulse and actual rotor position "Zero") must be determined experimentally or included with the motor. A sticker is typically affixed to motors supplied by NORD on which the setting is specified. Provided that the details on the motor are specified in °, these must be converted into rev (e.g. 90 ° = 0.250 rev).			

Information
PLC parameter P350 ff.

The description of the PLC-relevant parameters above P350 can be found in the manual BU 0550.

Control terminals

Parameter {factory setting}	Setting value / Description / Note		Supervisor	Parameter set
P400	Digital analog input 1 (<i>Analog input 1 function</i>)			P
0 ... 82 { 1 }	The analog input of the FI can be used for various functions. Setting of an analog or digital function is possible, whereby the selection of the function type is made in parameter P400. The possible functions are listed in the following tables.			

List of possible analog functions of the analog inputs

Value	Function	Description
00	Off	The analog input has no function. After the FI has been enabled via the control terminals, it will supply the set minimum frequency (P104).
01	Setpoint frequency	The specified analog range (matching of analog input) varies the output frequency between the set minimum and maximum frequencies (P104/P105).
02	Torque current limit	Based on the set torque current limit (P112), this can be altered by means of an analog value. 100% setpoint here corresponds to the set torque current limit P112.
03	Actual frequency PID*	Is required in order to set up a control circuit. The analog input (actual value) is compared with the setpoint (e.g. fixed frequency). The output frequency is adjusted as far as possible until the actual value equals the setpoint (see control values P413...P415).
04	Frequency addition **	The supplied frequency value is added to the setpoint.
05	Frequency subtraction**	he supplied frequency value is subtracted from the setpoint.
06	Current limit	Based on the set current limit (P1536), this can be altered via the analog input.
07	Maximum frequency	The maximum frequency of the FI is varied. 100% corresponds to the setting in parameter P411. 0% corresponds to the setting in parameter P410. The values for the minimum/maximum output frequencies (P104/P105) cannot be undershot/exceeded
08	Actual PID frequency limited*	Like Function 3, Actual frequency PID, however the output frequency cannot fall below the programmed minimum frequency value in Parameter P104. (no change to rotation direction)
09	Actual frequency PID monitored*	Like Function 3, Actual frequency PID, however the FI switches the output frequency off when the minimum frequency P104 is reached.
10	Servo mode torque	In servo mode ((P300) = "1") the motor torque can be set or limited using this function. Here the speed controller is switched off and a torque control is activated. The analog input is then the source of the setpoint value. Above firmware version SW 2.0, this function can be also be used with reduced control precision without servo mode or for ((P300) = "0").
11	Torque precontrol	A function which enables a value for the anticipated torque requirement to be entered in the controller (interference factor switching). This function can be used to improve the load take-up of lifting equipment with separate load detection.
12	Reserved	
13	Multiplication	The setpoint is multiplied by the stated analog value. The analog value adjusted to 100% then corresponds to a multiplication factor of 1.
14	Actual value process controller *	Activates the process controller, analog input 1 is connected to the actual value sensor (compensator, air can, flow volume meter, etc.). The mode (0-10 V or 0/4-20 mA) is set in P401.
15	Process controller setpoint *	as function 14, however the setpoint is specified (e.g. by a potentiometer). The actual value must be specified using another input.
16	Process controller precontrol *:	adds an adjustable additional setpoint after the process controller.
46	Setpoint Torque Process controller	Process controller torque setpoint
48	Motor temperature	Motor temperature measurement with KTY-84, details in Section 0
53	d-correction F process	"Diameter correction for PID process controller frequency"
54	d-correction Torque	"Diameter correction of torque"
55	d-correction F + Torque	"Diameter correction for PID process controller frequency and torque"

*) further details process controller: P400 and 4.4.
 **) The limits of these values are set by the parameters >Minimum frequency auxiliary setpoints< P410 and >Maximum frequency auxiliary setpoints< P411.

Further analog functions (47/49/56/57/58) are only relevant for POSICON.

NOTE: overview of various setpoints: 8.2 "Process controller".

(please see chapter 8.7 "Standardisation of setpoint / target values")

List of possible digital functions of the analog outputs

The analog inputs of the frequency inverter can also be parameterised to process digital signals.

The digital functions are set in the parameter of the relevant analog input according to the following assignment.

Value	Function	Value	Function
21	Enable right	42	... 45 POSICON → BU 0510
22	Enable left	46	Setpoint Torque Position control
23	Change of rotation direction	48	Motor temperature
24	Fixed frequency 1	50	Disable PID
25	Fixed frequency 2	51	Disable right rotation
26	Fixed frequency 3	52	Disable left rotation
27	Fixed frequency 4	53	d-correction F process
28	... Reserved	54	d-correction Torque
29	Hold frequency	55	d-correction F + Torque
30	Disable voltage	58	... reserved for POSICON → (BU 0510)
31	Emergency stop	67	Motorpot. Freq. +
32	Fault acknowledgement	68	Motorpot. Freq. -
33	... 34 Reserved	69	... Reserved
35	Jog frequency	70	Bit 0 fixed freq. array
36	Motor potentiometer	71	Bit 1 fixed freq. array
37	... Reserved	72	Bit 2 fixed freq. array
38	Watchdog	73	Bit 3 fixed freq. array
39	... 40 Reserved	74	Bit 4 fixed freq. array
41	Fixed frequency 5	75	... 82 POSICON → BU 0510

A detailed description of the digital functions can be found after parameters P420 ... P425. The functions of the digital inputs are identical to the digital functions of the analog inputs.

Permissible voltage when using digital functions: 7.5...30 V.

NOTE:

The analog inputs with digital functions do not comply with EN61131-2 (Type 1 digital inputs), because the idling currents are too low.

Parameter {factory setting}	Setting value / Description / Note		Supervisor	Parameter set
P401	Mode analog in. 1 (Analog input 1 mode)		S	
0 ... 5 { 0 }	This parameter determines how the FI reacts to an analog signal which is less than the 0 % adjustment (P402).			

0 = 0 – 10V limited: An analogue setpoint smaller than the programmed adjustment 0% (P402) does not lead to undershooting of the programmed minimum frequency (P104), i.e. it does not result in a change of the direction of rotation.

1 = 0 – 10V: If a setpoint smaller than the programmed adjustment 0% (P402) is present, this can cause a change in direction rotation. This allows rotation direction reversal using a simple voltage source and potentiometer.

E.g. internal setpoint with rotation direction change: P402 = 5 V, P104 = 0 Hz, Potentiometer 0-10 V → Rotation direction change at 5 V in mid-range setting of the potentiometer.

At the moment of reversal (hysteresis = ± P505), the drive stands still when the minimum frequency (P104) is smaller than the absolute minimum frequency (P505). A brake that is controlled by the FI will have entered the hysteresis range.

If the minimum frequency (P104) is greater than the absolute minimum frequency (P505), the drive reverses when the minimum frequency is reached. In the hysteresis range ± P104, the FI supplies the minimum frequency (P104), the brake controlled by the FI is not applied.

2 = 0 – 10V monitored: If the minimum adjusted setpoint (P402) is undershot by 10% of the difference value from P403 and P402, the FI output switches off. Once the setpoint is greater than $[P402 - (10\% * (P403 - P402))]$, it will deliver an output signal again. With the change to firmware version V 3.0 R0 the behaviour of the FI changes in that the function is only active if a function for the relevant input has been selected in P400

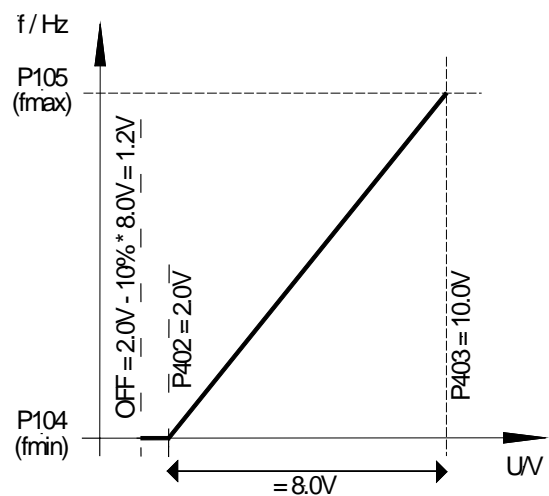

E.g. setpoint 4-20 mA: P402: Adjustment 0 % = 1 V; P403: Adjustment 100 % = 5 V; -10 % corresponds to -0.4 V; i.e. 1...5 V (4...20 mA) normal operating zone, 0.6...1 V = minimum frequency setpoint, below 0.6 V (2.4 mA) output switches off.

3 = - 10V – 10V: If a setpoint smaller than the programmed adjustment 0% (P402) is present, this can cause a change in direction rotation. This allows rotation direction reversal using a simple voltage source and potentiometer.

E.g. internal setpoint with rotation direction change: P402 = 5 V, P104 = 0 Hz, Potentiometer 0-10 V → Rotation direction change at 5 V in mid-range setting of the potentiometer.

At the moment of reversal (hysteresis = ± P505), the drive stands still when the minimum frequency (P104) is smaller than the absolute minimum frequency (P505). A brake that is controlled by the FI will not have entered the hysteresis range.

If the minimum frequency (P104) is greater than the absolute minimum frequency (P505), the drive reverses when the minimum frequency is reached. In the hysteresis range ± P104, the FI supplies the minimum frequency (P104), the brake controlled by the FI is not applied.

NOTE: The function -10 V – 10 V is a description of the method of function and not a reference to a bipolar signal (see example above).

4 = 0 – 10V with Error 1, "0 – 10V with shut-down on Error 1":

If the value of the 0% adjustment in (P402) is undershot, the error message 12.8 "Undershoot of Analogue In Min." is activated.

If the value of the 100% adjustment in (P402) is undershot, the error message 12.9 "Undershoot of Analogue In Max." is activated.

Even if the analogue value is outside the limits defined in (P402) and (P403), the setpoint value is limited to 0 - 100%.

The monitoring function only becomes active if an enable signal is present and the analogue value has reached the valid range (\geq (P402) or \leq (P403)) for the first time (e.g. pressure build-up after switching on a pump).

Once the function has been activated, it also operates if the actuation takes place via a field bus, for example, and the analogue input is not actuated at all.

5 = 0 – 10V m with Error 2, "0 – 10V with switch-off on Error 2":

See setting 4 ("0 - 10V with error switch off 1"), however:

In this setting the monitoring function only becomes active if an enable signal is present and the time during which the error monitoring is suppressed has elapsed. This suppression time is set in parameter (P216).

P402	Adjustment 1: 0% (Analog input 1 adjustment: 0%)		S													
-50.00 ... 50.00 V { 0.00 }	This parameter sets the voltage that should correspond with the minimum value of the selected function for the analog input 1. In the factory setting (setpoint) this value is equivalent to the setpoint set via P104 >Minimum frequency<. <p>Typical setpoints and corresponding settings:</p> <table data-bbox="523 1003 1264 1133"> <tr><td>0 – 10 V</td><td>→</td><td>0.00 V</td></tr> <tr><td>2 – 10 V</td><td>→</td><td>2.00 V (monitored for function 0-10 V)</td></tr> <tr><td>0 – 20 mA</td><td>→</td><td>0.00 V (internal resistance approx. 250 Ω)</td></tr> <tr><td>4 – 20 mA</td><td>→</td><td>1.00 V (internal resistance approx. 250 Ω)</td></tr> </table>	0 – 10 V	→	0.00 V	2 – 10 V	→	2.00 V (monitored for function 0-10 V)	0 – 20 mA	→	0.00 V (internal resistance approx. 250 Ω)	4 – 20 mA	→	1.00 V (internal resistance approx. 250 Ω)			
0 – 10 V	→	0.00 V														
2 – 10 V	→	2.00 V (monitored for function 0-10 V)														
0 – 20 mA	→	0.00 V (internal resistance approx. 250 Ω)														
4 – 20 mA	→	1.00 V (internal resistance approx. 250 Ω)														
P403	Adjustment 1: 100% (Analog input 1 adjustment: 100%)		S													
-50.00 ... 50.00 V { 10.00 }	This parameter sets the voltage that should correspond with the maximum value of the selected function for the analog input 1. In the factory setting (setpoint) this value is corresponds with the setpoint set via P105 >Maximum frequency<. <p>Typical setpoints and corresponding settings:</p> <table data-bbox="568 1361 1264 1469"> <tr><td>0 – 10 V</td><td>→</td><td>10.00 V</td></tr> <tr><td>2 – 10 V</td><td>→</td><td>10.00 V (monitored for function 0-10 V)</td></tr> <tr><td>0 – 20 mA</td><td>→</td><td>5.00 V (internal resistance approx. 250 Ω)</td></tr> <tr><td>4 – 20 mA</td><td>→</td><td>5.00 V (internal resistance approx. 250 Ω)</td></tr> </table>	0 – 10 V	→	10.00 V	2 – 10 V	→	10.00 V (monitored for function 0-10 V)	0 – 20 mA	→	5.00 V (internal resistance approx. 250 Ω)	4 – 20 mA	→	5.00 V (internal resistance approx. 250 Ω)			
0 – 10 V	→	10.00 V														
2 – 10 V	→	10.00 V (monitored for function 0-10 V)														
0 – 20 mA	→	5.00 V (internal resistance approx. 250 Ω)														
4 – 20 mA	→	5.00 V (internal resistance approx. 250 Ω)														

P400 ... P403

P401 = 0 → 0 - 10V limited

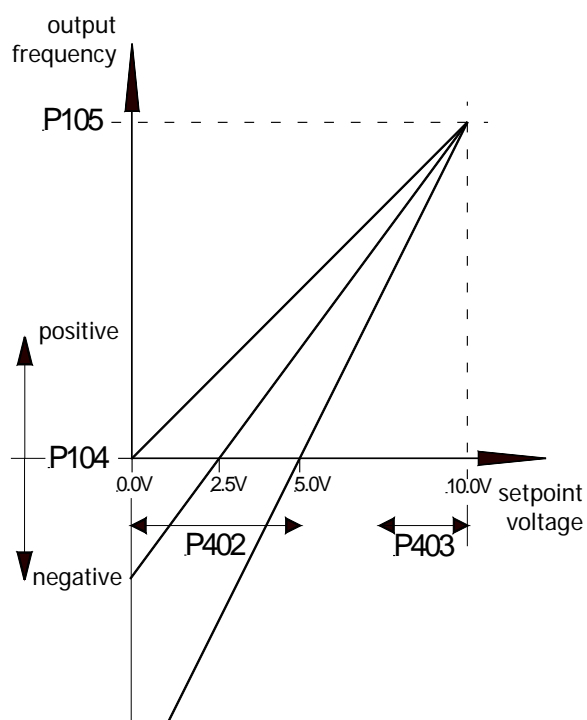
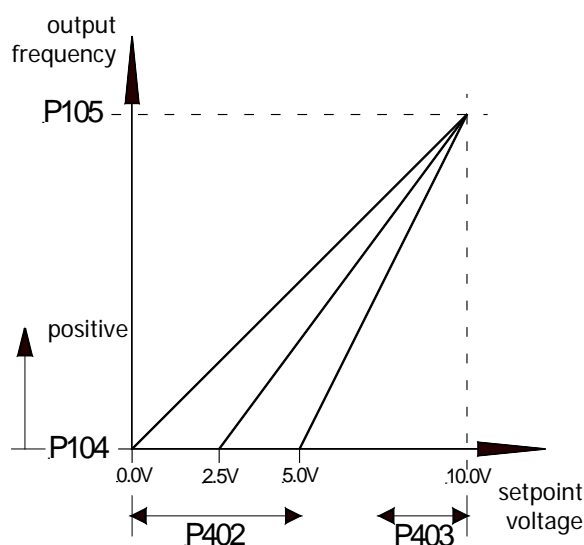
 P401 = 1 → 0 - 10V not limited

P404	Analog input filter 1 (Filter analog input 1)		S	
1 ... 400 ms { 100 }	Adjustable digital low-pass filter for the analog signal. Interference peaks are hidden, the reaction time is extended.			
P405	Digital input 2 function (Analog input 2 function)			P
0 ... 82 { 0 }	This parameter is identical to P400.			
P406	Analog input 2 mode (Analog input 2 mode)		S	
0 ... 5 { 0 }	0 = 0 – 10V limited 1 = 0 – 10V 2 = 0 – 10V monitored 3 = - 10V – 10V 4 = 0 – 10V with Error 1 5 = 0 – 10V with Error 2 This parameter is identical to P401. P402 changes to P407.			
P407	Adjustment 2: 0% (Analog input 2 adjustment: 0%)		S	
-50.00 ... 50.00 V { 0.00 }	This parameter is identical to P402.			

P408	Adjustment 2: 100% (Analog input 2 adjustment: 100%)		S										
-50.00 ... 50.00 V { 10.00 }	This parameter is identical to P403.												
P409	Analog input filter 2 (Filter analog input 2)		S										
1 ... 400 ms { 100 }	This parameter is identical to P404.												
P410	Min. freq. a-in 1/2 (Minimum frequency a-in 1/2 (auxiliary setpoint value))			P									
-400.0 ... 400.0 Hz { 0.0 }	<p>The minimum frequency that can act on the setpoint via the auxiliary setpoints. Auxiliary setpoints are all frequencies that are additionally delivered for further functions in the FI:</p> <table style="width: 100%; border: none;"> <tr> <td style="text-align: center;">Actual frequency PID</td> <td style="text-align: center;">Frequency addition</td> <td style="text-align: center;">Frequency subtraction</td> </tr> <tr> <td style="text-align: center;">Auxiliary setpoints via BUS</td> <td style="text-align: center;">Process controller</td> <td></td> </tr> <tr> <td colspan="3" style="text-align: center;">Min. frequency above analog setpoint (potentiometer)</td> </tr> </table>				Actual frequency PID	Frequency addition	Frequency subtraction	Auxiliary setpoints via BUS	Process controller		Min. frequency above analog setpoint (potentiometer)		
Actual frequency PID	Frequency addition	Frequency subtraction											
Auxiliary setpoints via BUS	Process controller												
Min. frequency above analog setpoint (potentiometer)													
P411	Max. freq. a-in 1/2 (Maximum frequency a-in 1/2 (auxiliary setpoint value))			P									
-400.0 ... 400.0 Hz { 50.0 }	<p>The maximum frequency that can act on the setpoint via the auxiliary setpoints. Auxiliary setpoints are all frequencies that are additionally delivered for further functions in the FI:</p> <table style="width: 100%; border: none;"> <tr> <td style="text-align: center;">Actual frequency PID</td> <td style="text-align: center;">Frequency addition</td> <td style="text-align: center;">Frequency subtraction</td> </tr> <tr> <td style="text-align: center;">Auxiliary setpoints via BUS</td> <td style="text-align: center;">Process controller</td> <td></td> </tr> <tr> <td colspan="3" style="text-align: center;">Min. frequency above analog setpoint (potentiometer)</td> </tr> </table>				Actual frequency PID	Frequency addition	Frequency subtraction	Auxiliary setpoints via BUS	Process controller		Min. frequency above analog setpoint (potentiometer)		
Actual frequency PID	Frequency addition	Frequency subtraction											
Auxiliary setpoints via BUS	Process controller												
Min. frequency above analog setpoint (potentiometer)													
P412	Nom. val. process ctrl. (Nominal value process controller)		S	P									
-10.0 ... 10.0 V { 5.0 }	Fixed specification of a setpoint for the process controller that will only occasionally be altered. Only with P400 = 14 ... 16 (process controller) (please see chapter 8.2 "Process controller").												
P413	PID control P comp. (P-component of PID controller)		S	P									
0.0 ... 400.0 % { 10.0 }	<p>This parameter is only effective when the function PID actual frequency is selected. The P-component of the PID controller determines the frequency jump if there is a control deviation based on the control difference. E.g.: At a setting of P413 = 10% and a rule difference of 50%, 5% is added to the actual setpoint.</p>												
P414	PID control I comp. (I-component of PID controller)		S	P									
0.0 ... 3,000.0 %/s { 10.0 }	<p>This parameter is only effective when the function PID actual frequency is selected. The I-component of the PID controller determines the frequency change, dependent on time. Up to SW 1.5 the setting range was 0.00 to 300.00 %/ms! This can cause incompatibilities in the transfer of data sets between FIs with different software versions.</p>												

P415	PID control D comp. (D-component of PID controller)		S	P
0 ... 400.0 %ms { 1.0 }	<p>This parameter is only effective when the function PID actual frequency is selected.</p> <p>If there is a rule deviation, the D-component of the PID controller determines the frequency change multiplied by time (%ms).</p> <p>If one of the analog inputs is set in the function actual value process controller, this parameter determines the controller limitation (%) after the PI controller. For further details, see Section 8.2.</p>			
P416	Ramp time PI setpoint (Ramp time PI setpoint value)		S	P
0.00 ... 99.99s { 2.00 }	<p>This parameter is only effective when the function PID actual frequency is selected.</p> <p>Ramp for PI setpoint</p>			

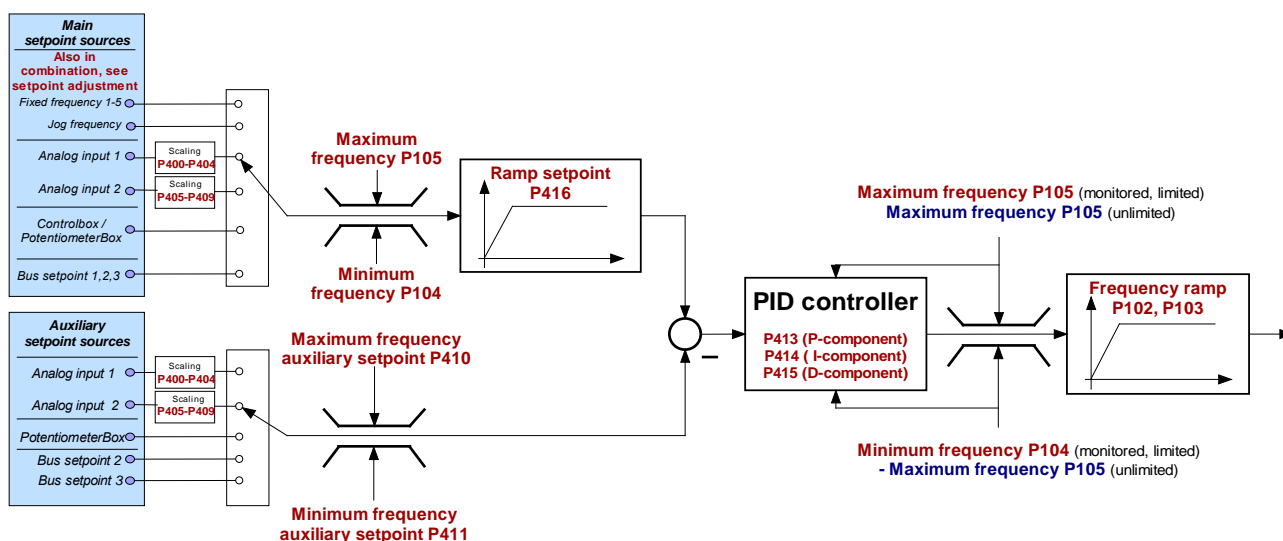

Fig.: Flow diagram for PID controller

P417	Analog output offset 1 (Offset analog output 1)		S	P
-10.0 ... 10.0 V { 0.0 }	<p>In the analog output function an offset can be entered to simplify the processing of the analog signal in other equipment.</p> <p>If the analog output has been programmed with a digital function, then the difference between the switch-on point and the switch-off point can be set in this parameter (hysteresis).</p>			
P418	Function analog output 1 (Function analog output 1)			P
0 ... 52 { 0 }	<p>Analog functions (max. load: 5 mA analog, 20 mA digital):</p> <p>An analog (0 ... +10V) voltage can be obtained from the control terminals (max. 5 mA). Various functions are available, whereby:</p> <p>0 Volt analog voltage always corresponds to 0 % of the selected value.</p> <p>10 V always corresponds to the motor nominal values (unless otherwise stated) multiplied by the P419 standardisation factor, e.g.:</p> $\Rightarrow 10\text{Volt} = \frac{\text{nominal motor value} \cdot P419}{100\%}$			

The possible functions are listed in the following tables.

List of possible analog functions of the analog outputs

Value	Function	Description
00	No function	No output signal at terminals.
01	Actual frequency	The analog voltage is proportional to the output frequency of the device
02	Actual speed	Is the synchronous speed calculated by the device, based on the present setpoint value. Load-dependent speed fluctuations are not taken into account. If Servo mode is being used, the measured speed will be output via this function.
03	Current	Is the effective value of the output current delivered by the device.
04	Torque current	Indicates the motor load torque calculated by the device. (100 % = P112)
05	Voltage	Is the output voltage delivered by the device.
06	DC link voltage	Is the DC voltage in the device. This is not based on the motor rated data. 10 V Volt, standardised at 100 %, is equivalent to 450V DC (230 V mains) or 850 Volt DC (480 V mains)!
07	Value of P542	The analog output can be set with parameter P542, regardless of the actual operating status of the device. With bus control, e.g. an analog value from the control unit can be tunnelled directly to the analog output of the FI.
08	Apparent power	The actual apparent power of the motor as calculated by the device
09	Effective power	The actual effective power calculated by the device
10	Torque [%]	The actual torque calculated by the device
11	Field [%]	The actual field in the motor, as calculated by the device
12	Actual frequency \pm	The analog voltage is proportional to the output frequency of the device, whereby the null point is shifted to 5 V. For rotation to the right, values between 5 V and 10 V are output, and for rotation to the left values between 5 V and 0 V.
13	Actual speed \pm	This is the synchronous rotation speed calculated by the FI, based on the current setpoint, where the null point has been shifted to 5 V. For rotation to the right, values from 5 V to 10 V are output and for rotation to the left, values from 5 V to 0 V. The measured speed is output via this function if servo mode is used.
14	Torque [%] \pm	Is the actual torque calculated by the FI, whereby the null point is shifted to 5 V. For drive torques, values between 5 V and 10 V are output, and for generator torque, values between 5 V and 0 V.
30	Setpoint freq. before ramp	displays the frequency produced by any upstream controllers (ISD, PID, etc.). This is then the setpoint frequency for the power stage after it has been adjusted by the acceleration or braking ramp (P102, P103).
31	Output via BUS PZD	the analog output is controlled via a bus system. The process data is directly transferred (P546, P547, P548 = 20).
33	Freq. of setpt. source,	"Frequency of setpoint source" (above SW version 1.6)
60	Reserved	(above SK540E \rightarrow BU 0550)

NOTE: overview of various setpoints: (please see chapter 8.7 "Standardisation of setpoint / target values").

List of possible digital functions of the analog outputs

All relay functions described in parameter P434 can also be transferred via the analog output. If a condition has been fulfilled, then there will be 10 V at the output terminals. Negation of the function can be specified in parameter P419.

Value	Function	Value	Function
15	External brake	32	FI ready
16	Inverter working	33	Frequency and setpoint source
17	Current limit	34	... 40 reserved (POSSICON → BU 0510)
18	Torque current limit	41	... 43 reserved
19	Frequency limit	44	BusIO In Bit 0
20	Setpoint reached	45	BusIO In Bit 1
21	Fault	46	BusIO In Bit 2
22	Warning	47	BusIO In Bit 3
23	Overcurrent warning	48	BusIO In Bit 4
24	Motor overtemperature warning	49	BusIO In Bit 5
25	Torque current limit active	50	BusIO In Bit 6
26	Value of P541	51	BusIO In Bit 7
27	Generator torque current limit	52	Value from Bus setpoint Output via Bus (if P546, P547 or P548 = 19), BUS Bit 4 then controls the analog output.
28	... 29 reserved	60	reserved (PLC → BU 0550)

Parameter {factory setting}	Setting value / Description / Note		Supervisor	Parameter set
P419	Scaling of analog output 1 (Scaling of analog output 1)			P
-500 ... 500 % { 100 }	<p>Analog functions P418 (= 0 ... 6 and 8 ... 14, 30)</p> <p>With this parameter an adjustment can be made to the analog output for the selected working range. The maximum analog output (10 V) corresponds to the scaling value of the appropriate selection.</p> <p>Therefore, if this parameter is raised from 100 % to 200 % at a constant working point, the analog output voltage is halved. The 10 Volt output signal then corresponds to twice the nominal value.</p> <p>For negative values the logic is reversed. An actual value of 0 % will then produce 10 V at the output and -100 % will produce 0 V.</p> <p>Digital functions P418 (= 15 ... 28, 34...52)</p> <p>The switching threshold can be set using this parameter for the functions Current limit (= 17), Torque current limit (= 18) and Frequency limit (= 19). A value of 100% refers to the corresponding motor nominal value (see also P435).</p> <p>With a negative value, the output function is output negated (0/1 → 1/0).</p>			
P420	Digital input 1 (Digital input 1)			
0 ... 74 { 1 }	<p>Enable right as factory setting, control terminal 21 (DIN1)</p> <p>Various functions can be programmed. These can be seen in the following table.</p>			

P421	Digital input 2 (Digital input 2)			
0 ... 74 { 2 }	Enable left as factory setting, control terminal 22 (DIN2) Various functions can be programmed. These can be seen in the following table.			
P422	Digital input 3 (Digital input 3)			
0 ... 74 { 8 }	Parameter set switching Bit 0 as factory setting, control terminal 23 (DIN3) Various functions can be programmed. These can be seen in the following table.			
P423	Digital input 4 (Digital input 4)			
0 ... 74 { 4 }	Fixed frequency 1 (P429) as factory setting, control terminal 24 (DIN4) Various functions can be programmed. These can be taken from the following table.			
P424	input function 5 (Digital input 5)			
0 ... 74 { 0 }	No function as factory setting, control terminal 25 (DIN5) Various functions can be programmed. These can be seen in the following table.			
P425	Digital input 6 (Digital input 6)	SK 520E or higher		
0 ... 74 { 0 }	No function as factory setting, control terminal 26 (DIN6) Various functions can be programmed. These can be seen in the following table.			

(SK 520/53xE) Function of digital input 7 = P470 , Control terminal 27 (DIN7)

... For a description of functions, see the following table(s).

List of the possible functions of digital inputs

Value	Function	Description	Signal
00	No function	Input switched off.	---
01	Enable right	The inverter delivers an output signal with the rotation field right if a positive setpoint is present. 0 → 1 Flank (P428 = 0)	High
02	Enable left	The inverter delivers an output signal with the rotation field left if a positive setpoint is present. 0 → 1 Flank (P428 = 0)	High
If the drive is to start up automatically when the mains is switched on (P428 = 1) a permanent High level for enabling must be provided (bridge between DIN1 and the control voltage output). If the functions "Enable right" and "Enable left" are actuated simultaneously, the FI is blocked. If the frequency controller is in fault status but the cause of the fault no longer exists, the error message is acknowledged with a 1 → 0 flank .			
03	Change of rotation direction	Causes the rotation field to change direction, combined with Enable right or left.	High
04	Fixed frequency 1 ¹	The frequency from P429 is added to the actual setpoint value.	High
05	Fixed frequency 2 ¹	The frequency from P430 is added to the actual setpoint value.	High
06	Fixed frequency 3 ¹	The frequency from P431 is added to the actual setpoint value.	High
07	Fixed frequency 4 ¹	The frequency from P432 is added to the actual setpoint value.	High
If several fixed frequencies are actuated at the same time, then they are added with the correct sign. In addition, the analogue setpoint (P400) and if necessary the minimum frequency (P104) are added.			
08	Switch-over of parameter sets	First Bit of the parameter set switch over, selection of the active parameter set 1...4 (P100).	High

Value	Function	Description	Signal
09	Hold frequency	During the acceleration or deceleration phase, a Low level will cause the actual output frequency to be "held". A high level allows the ramp to proceed.	Low
10	Block voltage ²	The FI output voltage is switched off; the motor runs down freely.	Low
11	Quick stop ²	The FI reduces the frequency according to the programmed fast stop time from P426.	Low
12	Error acknowledgement ²	Error acknowledgement with an external signal. If this function is not programmed, an fault can also be acknowledged by a low enable setting (P506).	0→1 Flank
13	PTC input ²	Analog evaluation of signal present. Switching threshold approx. 2.5 V, Switch-off delay = 2 sec, warning after 1 sec. NOTE: Function 13 can only be used via DIN 5 up to SK 535E, sizes 1 - 4! For SK 54xE and sizes above Size 5, there is a separate connection which cannot be deactivated. If the motor is equipped with a thermistor, for these devices both terminals must be bridged in order to deactivate the function (status as delivered).	level
14	Remote control ^{2,4}	With Bus system control, low level switches the control to control via control terminals.	High
15	Jog frequency ¹	The fixed frequency value can be adjusted using the HIGHER/LOWER and ENTER keys (P113), if control is via the ControlBox or ParameterBox.	High
16	Motor potentiometer	As in setting 09, however, the frequency is not maintained below the minimum frequency P104 and above the maximum frequency P105.	Low
17	Para. Set Switchovr. 2	Second Bit of the parameter set switch over, selection of the active parameter set 1...4 (P100).	High
18	Watchdog ²	Input must see a High flank cyclically (P460), otherwise error E012 will cause a shutdown. Function starts with the 1st high flank.	0→1 Flank
19	Setpoint 1 on/off	Analog input switch-on and switch-off 1/2 (high = ON) The low signal sets the analog input to 0 % which does not lead to shut-down when the minimum frequency (P104) > than the absolute minimum frequency (P505).	High
20	Setpoint 2 on/off		
21	Fixed frequency 5 ¹	The frequency from P433 is added to the actual setpoint value.	High
22	... 25	<i>Reserved for POSICON (BU 0510)</i>	
26	... 29 impulse functions:	<i>Description below:</i>	
30	Disable PID	Switching the PID controller / process controller function on and off (high = ON)	High
31	Disable right running ²	Blocks the >Enable right/left< via a digital input or Bus control. Does not depend on the actual direction of rotation of the motor (e.g. following negated setpoint).	Low
32	Disable left running ²		Low
33	... 42 impulse functions:	<i>Description below (only SK 500E ... 535E).</i>	
43	... 44 Speed measurement with HTL encoder	<i>Description below:</i>	
45	3-W-Ctrl.Start-Right (Closing button)	3-Wire-Control, this control function provides an alternative to enable R/L (01, 02), in which a permanently applied level is required.	0→1 Flank
46	3-W-Ctrl.Start-Left (Closing button)	Here, only a control impulse is required to trigger the function. Control of the FI can therefore be performed entirely with buttons.	0→1 Flank
49	3-Wire-Ctrl.Stop (Opening button)	A pulse on the function "Reverse direction of rotation" (see Function 65) inverts the present direction of rotation. This function is reset with a "Stop signal" or by activating a button for the functions 45, 46, 49.	1→0 Flank
47	Motorpot.Freq.+	In combination with enable R/L the output frequency can be continuously varied. To save a current value in P113, both inputs must be at a High voltage for 0.5 s. This value then applies as the next starting value for the same direction of rotation (Enable R/L) otherwise start at f_{MIN} . Values from other setpoint sources (e.g. fixed frequencies) are not taken into account.	High
48	Motorpot.Freq.-		High
50	Bit 0 Fixed. freq.Array	Fixed frequency array, binary coded digital inputs to generate up to 32 fixed frequencies. (P465: -01...-31)	High
51	Bit 1 Fixed. freq.Array		High
52	Bit 2 Fixed. freq.Array		High

Value	Function	Description	Signal
53	Bit 3 Fixed. freq.Array		High
54	Bit 4 Fixed. freq.Array		High
55	... 64	<i>Reserved for POSICON (BU 0510)</i>	
65	3-Wire Direction (Rotation reversal button)	See functions 45, 46, 49	0→1 Flank
66	... 69	<i>Reserved</i>	
70	Evacuation run above SW 1.7	Only for devices with external 24V control voltage (SK 5x5E). There is therefore also the possibility of operation with a very low link circuit voltage. With this function the charging relay is activated and the under-voltage and phase error detection are deactivated. NOTICE! There is no overload monitoring! (e.g. lifting gear)	High
71	Motor pot.F+ and Save ³ SW 1.6 and above	Motor potentiometer function frequency +/- with automatic saving. With this motor potentiometer function (SW 1.6 and above) a setpoint value (sum) is set via the digital inputs, which is simultaneously saved. With control enabling R/L this is then started up in the correspondingly enabled direction. On change of direction the frequency is retained. Simultaneous activation of the +/- function causes the frequency setpoint value to be set to zero.	High
72	Motor pot.F+ and Save ³ SW 1.6 and above	The frequency setpoint can also be set in the operating value display (P001=30, 'Actual. setpoint MP-S') or displayed or set in P718 and pre-set to the operating status "Ready for switch-on". Any minimum frequency set (P104) is still effective. Other setpoint values, e.g. analogue or fixed frequencies can be added or subtracted. Adjustment of the frequency setpoint value is performed with the ramps from P102/103.	High
73 ²	Right disable +fast	As for setting 31, however coupled to the function "Emergency Stop"	Low
74 ²	Left disable+fast	As for setting 32, however coupled to the function "Emergency Stop"	Low
77		<i>Reserved for POSICON (BU 0510)</i>	
80		<i>Reserved for PLC (BU 0550)</i>	
1	If neither of the digital inputs is programmed for left or right enable, then the actuation of a fixed frequency or jog frequency will enable the frequency inverter. The rotation field direction depends on the sign of the setpoint.		
2	Also effective for Bus control (e.g. RS232, RS485, CANbus, CANopen, ...)		
3	With SK 5x5 E devices the frequency inverter control unit must be supplied with power for a further 5 minutes after the last change of the motor potentiometer in order to permanently save the data.		
4	Function cannot be selected via BUS IO In Bits		

Pulse input functions: 2...22kHz (only DIN2/3)

Digital inputs 2 and 3 can be used indirectly for the evaluation of analog signals. For these functions the particular input evaluates the impulse frequency present. The frequency range 2kHz to 22kHz thereby covers the range of values from 0 to 100%. The inputs operate up to a maximum impulse frequency of 32kHz. The voltage level may be between 15V and 24V and the switch-on cycle between 50 and 80%.

Value	Function	Description	Signal
26	Torque current limit ²	Adjustable load limit, the output frequency is reduced when this is reached. → P112	Impulse
27	Actual PID frequency ^{2 3}	Possible feedback of actual value for the PID controller	Impulse
28	Frequency addition ^{2 3}	Addition to other setpoint frequencies	Impulse
29	Frequency subtraction ^{2 3}	Subtraction of other setpoint frequencies	Impulse
33	Current limit ²	Based on the set current limit (P536), this can be changed using the digital/analog input.	Impulse

Value	Function	Description	Signal
34	Maximum frequency ^{2 3}	The maximum frequency of the FI is set in the analog range. 100% corresponds to the setting in parameter P411. 0% corresponds to the setting in parameter P410. The values for the minimum/maximum output frequencies (P104/P105) cannot be undershot/exceeded	Impulse
35	Act.freq PID limited ^{2 3}	<i>Actual PID frequency limited</i> , is required to set up a control loop. The digital/analog input (actual value) is compared with the setpoint (e.g. other analog input or fixed frequency). The output frequency is adjusted as far as possible until the actual value equals the setpoint. (see control variables P413 – P416) The output frequency cannot fall below the programmed minimum frequency value in parameter P104. (No rotation direction change!)	Impulse
36	Act. freq. PID controlled ^{2 3}	As function 35, >Actual frequency PID limited< but the FI switches the output frequency off when the >Minimum frequency< P104 is reached.	Impulse
37	Servo mode torque ²	The motor torque can be set or limited via this function in Servo mode.	Impulse
38	Torque precontrol ²	A function which enables a value for the anticipated torque requirement to be entered in the controller (interference factor switching). This function can be used to improve the load take-up of lifting equipment with separate load detection. → P214	Impulse
39	Multiplication ³	This factor multiplies the master setpoint value.	Impulse
40	Actual value process controller	As for P400 = 14-16	Impulse
41	Setpoint process controller		Impulse
42	Process controller lead		Impulse
2) Also effective for bus control (RS232, RS485, CANbus, CANopen, DeviceNet, Profibus, InterBus, AS-Interface)			
3) The limits of these values are set by the parameters >Minimum frequency auxiliary setpoints< P410 and >Maximum frequency auxiliary setpoints< P411.			

HTL encoder function (only DIN2/4)

For the evaluation of an HTL encoder, the digital inputs DIN2 and DIN4 must be parameterised with the following functions.

Value	Function	Description	Signal
43	Track A HTL encoder	This function can <u>only</u> be used for digital inputs 2 (DIN2) and 4 (DIN4) ! A 24V HTL encoder can be connected to DIN 2 and DIN 4 in order to measure the speed. The maximum frequency at the DIN is limited to 10kHz. Accordingly, a suitable encoder (low pulse number) or suitable mounting (slow speed) SHOULD BE USED.	Impulse <10kHz
44	Track B HTL encoder	The direction of counting can be changed by exchanging the functions on the digital inputs. Further settings are in P461, P462, P463.	Impulse <10kHz

Parameter {factory setting}	Setting value / Description / Note		Supervisor	Parameter set
P426	Quick stop time (Quick stop time)			P
0 ... 320.00 sec { 0.10 }	<p>Setting of the stop time for the fast stop function which can be triggered either via a digital input, the bus control, the keyboard or automatically in case of a fault.</p> <p>Emergency stop time is the time for the linear frequency decrease from the set maximum frequency (P105) to 0Hz. If an actual setpoint <100% is being used, the emergency stop time is reduced correspondingly.</p>			
P427	Emergency stop on error (Emergency stop on error)		S	
0 ... 3 { 0 }	<p>Activation of automatic emergency stop following error</p> <p>0 = OFF: Automatic emergency stop following error is deactivated</p> <p>1 = Mains supply failure: Automatic emergency stop following mains supply failure</p> <p>2 = In case of faults: Automatic emergency stop following fault</p> <p>3 = Fault or mains failure: Automatic emergency stop in case of fault or mains failure</p> <p>An emergency stop can be triggered by the errors E2.x, E7.0, E10.x, E12.8, E12.9 and E19.0.</p>			
P428	Automatic starting (Automatic starting)		S	P
0 ... 1 { 0 }	<p>In the standard setting (P428 = 0 → Off) the inverter requires a flank to enable (signal change from "low → high") at the relevant digital input.</p> <p>In the setting On → 1 the FI reacts to a High level. This function is only possible if the FI is controlled using the digital inputs. (see P509=0/1)</p> <p>In certain cases, the FI must start up directly when the mains are switched on. For this P428 = 1 → On can be set. If the enable signal is permanently switched on, or equipped with a cable jumper, the FI starts up immediately.</p> <p>NOTE: (P428) not "ON" if (P506) = 6, Danger! (See note on (P506))</p>			
P429	Fixed frequency 1 (Fixed frequency 1)			P
-400.0 ... 400.0 Hz { 0.0 }	<p>Following actuation via a digital input and enabling of the FI (right or left), the fixed frequency is used as a setpoint. A negative setting value will cause a direction change (based on the <i>Enable rotation direction</i> P420 – P425, P470).</p> <p>If several fixed frequencies are actuated at the same time, then the individual values are added with the correct sign. This also applies to combinations with the jog frequency (P113), analog setpoint (if P400 = 1) or minimum frequency (P104).</p> <p>The frequency limits (P104 = f_{min}, P105 = f_{max}) cannot be over or undershot.</p> <p>If none of the digital inputs are programmed for enable (right or left), the simple fixed frequency signal results in an enable. A positive fixed frequency corresponds to a right enable, a negative to a left enable.</p>			
P430	Fixed frequency 2 (Fixed frequency 2)			P
-400.0 ... 400.0 Hz { 0.0 }	For a description of the function of the parameter, see P429 >Fixed frequency 1<			

P431	Fixed frequency 3 (Fixed frequency 3)			P
-400.0 ... 400.0 Hz { 0.0 }	For a description of the function of the parameter, see P429 >Fixed frequency 1<			
P432	Fixed frequency 4 (Fixed frequency 4)			P
-400.0 ... 400.0 Hz { 0.0 }	For a description of the function of the parameter, see P429 >Fixed frequency 1<			
P433	Fixed frequency 5 (Fixed frequency 5)			P
-400.0 ... 400.0 Hz { 0.0 }	For a description of the function of the parameter, see P429 >Fixed frequency 1<			
P434	Relay 1 function (Function of output 1 (Relay 1 – MFR1))			P
0 ... 39 { 1 }	<p>Control terminals 1/2: The settings 3 to 5 and 11 work with a 10% hysteresis, i.e. the relay contact closes (Function 11 opens) when the limit value is reached and opens (function 11 closes) when a 10% smaller value is undershot. This behaviour can be inverted with a negative value in P435.</p> <p>Various functions can be programmed. These can be seen in the following table.</p>			

List of possible functions of the relays and digital outputs

Value	Function	Description	Signal*
00	No function	Input switched off.	Low
01	External brake	For the control of a mechanical brake on the motor. The relay switches at a programmed absolute minimum frequency (P505). For typical brakes a setpoint delay of 0.2 ... 0.3 seconds should be programmed (see also P107). A mechanical brake may be directly switched by AC current. (Note the technical specification of the relay contacts!)	High
02	Inverter working	the closed relay contact indicates voltage at the inverter output (U - V - W) (also DC run-on(→ P559)).	High
03	Current limit	Based on the setting of the motor rated current in P203. This value can be adjusted with the standardisation (P435).	High
04	Torque current limit	Based on motor data settings in P203 and P206. Signals a corresponding torque load on the motor. This value can be adjusted with the standardisation (P435).	High
05	Frequency limit	Based on motor nominal frequency setting in P201. This value can be adjusted with the standardisation (P435).	High
06	Setpoint reached	indicates that the FI has completed the frequency increase or decrease. Setpoint frequency = actual frequency! From a difference of 1 Hz → Setpoint not reached - contact opens.	High
07	Fault	General fault message, fault is active or not yet acknowledged. → Error: contact opens, ready: contact closes	Low
08	Warning	General warning - a limit value was reached that could lead to a later shutdown of the FI.	Low
09	Overcurrent warning	At least 130% of the nominal FI current was supplied for 30 seconds.	Low
10	Motor overtemperature warning	Motor overtemperature (warning): The motor temperature is evaluated via the PTC input or a digital input. →Motor is too hot. This warning is given immediately, overheating switch-off after 2 seconds.	Low
11	Torque current limit active	Torque current limit/Current limit active (warning): The limiting value in P112 or P536 has been reached. A negative value in P435 inverts the reaction. Hysteresis = 10 %.	Low

Value	Function	Description	Signal*
12	Value of P541	The output can be set using parameter P541 independently of the actual operating status of the FI.	High
13	Generator torque current limit	Limit value in P112 was reached in the generator range. Hysteresis = 10 %.	High
14		... 17 Reserved	--
18	FI ready	The FI is ready for operation. After being enabled it delivers an output signal.	High
19		... 29 reserved POSICON (BU 0510)	--
30	BusIO In Bit 0	Control by Bus In Bit 0 (P546 ...)	High
31	BusIO In Bit 1	Control by Bus In Bit 1 (P546 ...)	High
32	BusIO In Bit 2	Control by Bus In Bit 2 (P546 ...)	High
33	BusIO In Bit 3	Control by Bus In Bit 3 (P546 ...)	High
34	BusIO In Bit 4	Control by Bus In Bit 4 (P546 ...)	High
35	BusIO In Bit 5	Control by Bus In Bit 5 (P546 ...)	High
36	BusIO In Bit 6	Control by Bus In Bit 6 (P546 ...)	High
37	BusIO In Bit 7	Control by Bus In Bit 7 (P546 ...)	High
38	Value from Bus setpoint	Value from bus setpoint (P546 ...)	High
Details can be found in the bus manuals			
39	STO inactive	The relay / bit deactivates if STO or the Safe Stop are active.	High
40		reserved PLC (BU 0550)	
* For relay contacts (High = "Contact closed", Low = "Contact open")			

Parameter {factory setting}	Setting value / Description / Note		Supervisor	Parameter set
P435	Relay 1 scaling (Scaling of output 1 (Relay 1 – MFR1))			P
-400 ... 400 % { 100 }	Adjustment of the limit values of the relay function. For a negative value, the output function will be output negative. Reference to the following values: Current limit (3) = x [%] · P203 >Rated motor current< Torque current limit (4) = x [%] · P203 · P206 (calculated rated motor torque) Frequency limit (5) = x [%] · P201 >Rated motor frequency<			
P436	Relay 1 hysteresis (Hysteresis of output 1 (Relay 1 – MFR1))		S	P
1 ... 100 % { 10 }	Difference between switch-on and switch-off point to prevent oscillation of the output signal.			
P441	Relay 2 function (Function of output 2 (Relay 2 – MFR2))			P
0 ... 39 { 7 }	Control terminals 3/4: Functions are identical to P434!			
P442	Relay 2 scaling (Scaling of output 2 (Relay 2 – MFR1))			P
-400 ... 400 % { 100 }	Functions are identical to P435!			

P443	Relay 2 hysteresis (Hysteresis of output 2 (Relay 2 – MFR1))		S	P
1 ... 100 % { 10 }	Functions are identical to P436!			
P450	Relay 3 function (Function of output 3 (DOUT1))	SK 520E or higher		P
0 ... 39 { 0 }	Control terminals 5/40: Functions are identical to P434! Digital output, 15V against DGND (for SK 5x5E devices, deviations of the signal level are possible).			
P451	Relay 3 scaling (Scaling of output 3 (DOUT1))	SK 520E or higher		P
-400 ... 400 % { 100 }	Functions are identical to P435!			
P452	Relay 3 Hyst. (Output 3 hysteresis (DOUT1))	SK 520E or higher	S	P
1 ... 100 % { 10 }	Functions are identical to P436!			
P455	Relay 4 function (Function of output 4 (DOUT2))	SK 520E or higher		P
0 ... 39 { 0 }	Control terminals 7/40: Functions are identical to P434! Digital output, 15V against DGND (for SK 5x5E devices, deviations of the signal level are possible).			
P456	Relay 4 scaling (Scaling of output 4 (DOUT2))	SK 520E or higher		P
-400 ... 400 % { 100 }	Functions are identical to P435!			
P457	Relay 4 Hyst. (Output 4 hysteresis (DOUT2))	SK 520E or higher	S	P
1 ... 100 % { 10 }	Functions are identical to P436!			
P460	Time Watchdog (Time Watchdog)		S	
-250.0 ... 250.0 sec { 10.0 }	<p>0.1 ... 250.0 = The time interval between the expected Watchdog signals (programmable function of the digital inputs P420 – P425). If this time interval elapses without a pulse being registered, switch off and error message E012 are actuated.</p> <p>0.0 = customer error: As soon as a high-low flank or a low signal is detected at a digital input (function 18) the FI switches off with error message E012.</p> <p>-250.0 ... -0.1 = Rotor running watchdog: In this setting the rotor running watchdog is active. The time is defined by the number of the value which has been set. When the FI is switched off, there is no watchdog message. After each enable, a pulse must first be received before the watchdog is activated.</p>			

P461	Function 2 Encoder <i>(Encoder function 2)</i>		S	
0 ... 5 { 0 } from hardware status CAA	<p>The actual speed list value supplied to the FI by an HTL incremental encoder can be used for various functions in the FI. (The settings are identical to (P325)). The HTL encoder is connected via digital inputs 2 and 4. The parameters (P421) and (P423) must be set accordingly to functions 43 "Track A" and 44 "Track B". Due to the frequency limit (max. 10 kHz) only restricted encoder solutions (P462) are possible with these digital inputs. The mounting location (motor shaft or output side) of the encoders is taken into account by the parameterisation of an appropriate speed ratio (P463).</p> <p>0 = Speed measurement Servo mode: The actual motor speed list value is used for the servo mode. The ISD control cannot be switched off in this function.</p> <p>1 = PID actual frequency value: The actual speed of a system is used for speed control. This function can also be used for controlling a motor with a linear characteristic curve. Here P413 and P414 determine the P and I proportion of the control.</p> <p>2 = Frequency addition: The determined speed is added to the actual setpoint value.</p> <p>3 = Frequency subtraction: The determined speed is subtracted from the actual setpoint.</p> <p>4 = Maximum frequency: The maximum possible output frequency / speed is limited by the speed of the encoder.</p> <p>5 = Reserved: see BU510</p>			
P462	Pulse number 2 Rotary encoder <i>(Pulse number of function 2)</i>		S	
16 ... 8192 { 1024 }	<p>Input of the pulse-count per rotation (16 - 8192) of the connected HTL incremental encoder.</p> <p>If the direction of rotation of the encoder is not the same as that of the motor controller, (depending on installation and wiring), it can be compensated for by selecting the corresponding negative pulse numbers.</p>			
P463	2. Encoder ratio <i>(2nd encoder speed ratio)</i>		S	
0.01 ... 100.0 { 1.00 }	<p>If the HTL incremental encoder is not mounted directly on the motor shaft, the correct speed ratio for the motor speed and the encoder speed must be set.</p> $P463 = \frac{\text{Motor speed}}{\text{Encoder speed}}$ <p>Only if P461 = 1, 2, 3 4 or 5, therefore not in Servo mode (motor speed control)</p>			
P464	Fixed frequencies mode <i>(Fixed frequencies mode)</i>		S	
0 ... 1 { 0 }	<p>This parameter determines the form in which fixed frequencies are to be processed.</p> <p>0 = Addition to main setpoint: Fixed frequencies and the fixed frequency array are added to each other. I.e. they are added together, or added to an analog setpoint to which limits are assigned according to P104 and P105.</p> <p>1 = Main setpoint: Fixed frequencies are not added - neither together, nor to analog setpoints. If for example, a fixed frequency is switched to an existing analog setpoint, the analog setpoint will no longer be considered. Programmed frequency addition or subtraction with an analog input value or a bus setpoint is still possible and valid, as is the addition to the setpoint of a motor potentiometer function (function of digital inputs: 71/72)</p> <p>If several fixed frequencies are selected simultaneously, the frequency with the highest value has priority (E.g.: $20 > 10$ or $20 > -30$).</p> <p>Note: The highest active fixed frequency is added to the setpoint value of the motor potentiometer if the functions 71 or 72 are selected for 2 digital inputs.</p>			

P465	[-01] ... [-31]	Fixed freq. Array <i>(Fixed frequency / Array)</i>			
-400.0 ... 400.0 Hz { 0.0 }		In the array levels, up to 31 different fixed frequencies can be set, which in turn can be encoded for the functions 50...54 in binary code for the digital inputs.			
P466		Min.freq. process cont. <i>(Minimum frequency process controller)</i>		S	P
0.0 ... 400.0 Hz { 0.0 }		With the aid of the minimum frequency process controller the control ratio can also be kept to a minimum ratio, even with a master value of "zero", in order to enable adjustment of the compensator. More details can be found in P400 and (please see chapter 8.2 "Process controller").			
P470		Digital input 7 <i>(Digital input 7)</i>	SK 520E or higher		
0 ... 74 { 0 }		No function as factory setting, control terminal 27 (DIN7) Various functions can be programmed. These can be taken from tables for P420...P425.			
P475	[-01] ... [-10]	delay on/off switch <i>(Digital function switch on/off delay)</i>		S	
-30,000 ... 30,000 sec { all 0,000 }		Adjustable switch-on/off delay for the digital inputs and the digital functions of the analog inputs. Use as a switch-on filter or simple process control is possible. [-01] = Digital input 1 [-02] = Digital input 2 [-03] = Digital input 3 [-04] = Digital input 4 [-05] = Digital input 5 Positive values = switch-on delayed			[-06] = Digital input 6 (above SK 520E) [-07] = Digital input 7 (above SK 520E) [-08] = Digital function, analog input 1 [-09] = Digital function, analog input 2 [-10] = Digital input 8 (above SK 540E) Negative values = switch-off delayed

P480	[-01] ... [-12]	Functional BusIO In Bits <i>(Bus I/O In Bits function)</i>		S	
-------------	-------------------------------------	--	--	----------	--

0 ... 80
{ all 0 }

The Bus I/O In Bits are perceived as digital inputs (P420). They can be set to the same functions. In order to use this function, one of the bus setpoints (P546) must be set to >Bus I/O In Bits 0-7 <. The required function must then be assigned to the relevant bit.

With the SK 54xE in association with IO extension modules (e.g. SK TU41OE) these I/O bits can also process their input signals.

array	... SK 535E	SK 54xE	Comments
[-01] =	Bus / AS-i Dig In1	Bus / 2.IOE Dig In1	(Bus I/O In Bit 0)
[-02] =	Bus / AS-i Dig In2	Bus / 2.IOE Dig In2	(Bus I/O In Bit 1)
[-03] =	Bus / AS-i Dig In3	Bus / 2.IOE Dig In3	(Bus I/O In Bit 2)
[-04] =	Bus / AS-i Dig In4	Bus / 2.IOE Dig In4	(Bus I/O In Bit 3)
[-05] =	AS-i Initiator 1	Bus / 1.IOE Dig In1	(Bus I/O In Bit 4)
[-06] =	AS-i Initiator 2	Bus / 1.IOE Dig In2	(Bus I/O In Bit 5)
[-07] =	AS-i Initiator 3	Bus / 1.IOE Dig In3	(Bus I/O In Bit 6)
[-08] =	AS-i Initiator 4	Bus / 1.IOE Dig In4	(Bus I/O In Bit 7)
[-09] =	Flag 1 ¹⁾		
[-10] =	Flag 2 ¹⁾		
[-11] =	Bit 8 Bus control word		
[-12] =	Bit 9 Bus control word		

The possible functions for the Bus In Bits can be found in the table of functions for the digital inputs. Function {14} "Remote control" is not possible.

¹⁾ The flag function is only possible with control via control terminals.

P481	[-01] ... [-10]	Functional BusIO Out Bits <i>(Function of Bus I/O Out Bits)</i>		S	
-------------	-------------------------------------	---	--	----------	--

0 ... 40
{ all 0 }

The bus I/O Out bits are perceived as digital outputs (P434). They can be set to the same functions. In order to use this function, one of the bus actual values (P543) must be set to >Bus I/O In Bits 0-7 <. The required function must then be assigned to the relevant bit.

With the SK 54xE in association with IO extension modules (e.g. SK TU41OE) these I/O bits can also process their input signals.

Array	... SK 535E	SK 54xE	Comments
[-01] =	Bus / AS-i Dig Out1	Bus / AS-i Dig Out1	(Bus I/O Out Bit 0)
[-02] =	Bus / AS-i Dig Out2	Bus / AS-i Dig Out2	(Bus I/O Out Bit 1)
[-03] =	Bus / AS-i Dig Out3	Bus / AS-i Dig Out3	(Bus I/O Out Bit 2)
[-04] =	Bus / AS-i Dig Out4	Bus / AS-i Dig Out4	(Bus I/O Out Bit 3)
[-05] =	AS-i Actuator 1	Bus / 1.IOE Dig Out1	(Bus I/O Out Bit 4)
[-06] =	AS-i Actuator 2	Bus / 1.IOE Dig Out2	(Bus I/O Out Bit 5)
[-07] =	Flag 1 ¹⁾	Bus / 2.IOE Dig Out1	(Bus I/O Out Bit 6)
[-08] =	Flag 2 ¹⁾	Bus / 2.IOE Dig Out2	(Bus I/O Out Bit 7)
[-09] =	Bit 10 Bus status word		
[-10] =	Bit 11 Bus status word		
[-11] =			
[-12] =			

The possible functions for the Bus Out Bits can be found in the table of functions for the digital outputs or the relays.

For further details, please refer to the manual for the AS interface, BU 0090.

¹⁾ The flag function is only possible with control via control terminals.

P480 ... P481 Using flags

With the aid of the two flags it is possible to define simple, logical sequences of functions.

To do this, the "triggers" for a function (e.g. a motor PTC overtemperature warning) are defined in parameter (P481) in arrays [-07] - "Flag 1" or [-08] - "Flag 2"

As well as this, the function which the frequency inverter is to execute when the "trigger" is active - i.e. the response by the frequency inverter is defined in parameter (P480) in arrays [-09] or [-10].

Example:

In an application, if the temperature of the motor reaches the overtemperature range ("Overtemperature motor PTC") the frequency inverter is to immediately reduce the speed to a specific speed (e.g. by means of an active fixed frequency). This is to be implemented by "Deactivation of analog input 1" via which in this example, the actual setpoint is normally set.

This is used to reduce the load on the motor, so that the temperature can stabilise or the drive unit reduces speed to a defined value before a shut-down due to error is made.

Step	Description	Function
1	Determine the trigger Set Flag 1 to the "Motor overtemperature" function	P481 [-07] → Function "12"
2	Specify the reaction, Set Flag 1 to the function "Setpoint 1 On/Off"	P480 [-09] → Function "19"

It should be noted that depending on the function which is selected in (P481) the function may need to be inverted by modification of the standardisation (P482).

P482	[-01] ... [-10]	Norm. BusIO Out Bits (Scaling of bus I/O Out bits)		S	
-400...400 % { all 100 }		Adjustment of the limit values of the relay functions/Bus Out Bits. For a negative value, the output function will be output negative. When the limit value is reached and the setting values are positive, the relay contact closes, with negative setting values the relay contact opens. The assignment of the arrays correspond to those of parameter (P481).			
P483	[-01] ... [-10]	Hyst. BusIO Out Bits (Hysteresis of bus I/O Out bits)		S	
1...100 % { all 10 }		Difference between switch-on and switch-off point to prevent oscillation of the output signal. The assignment of the arrays correspond to those of parameter (P481).			

Additional parameters

Parameter {factory setting}	Setting value / Description / Note		Supervisor	Parameter set																														
P501	[-01] Inverter name ... [-20] (Inverter name)																																	
A...Z _(char) { 0 }	Free input of a designation (name) for the device (max. 20 characters). With this, the frequency inverter can be uniquely identified for setting with NORD CON software or within a network.																																	
P502	[-01] Value Masterfunction ... [-05] (Value master function)		S	P																														
0 ... 57 { all 0 }	<p>Selection of the master value of a Master for output to a bus system (see P503) - (up to SK 535E: max. 3 master values, SK 540 and above: max. 5 master values). The assignment of these master values to the slave is carried out via (P546) (...P548):</p> <p>[-01] = Master value 1 [-02] = Master value 2 [-03] = Master value 3 <i>SK 540E and above:</i> [-04] = Master value 4 [-05] = Master value 5</p> <hr/> <p>Selection of possible setting values for master values:</p> <table border="0"> <tr> <td>00 = Off</td> <td>09 = Error code</td> <td>19 = Frequency master value</td> </tr> <tr> <td>01 = Actual frequency</td> <td>10 = <i>Reserved</i></td> <td>20 = Setpoint freq. after ramp</td> </tr> <tr> <td>02 = Actual speed</td> <td>11 = <i>Reserved</i></td> <td>21 = Actual freq. w/o slip</td> </tr> <tr> <td>03 = Electricity</td> <td>12 = BusIO Out Bits 0-7</td> <td>22 = Speed encoder</td> </tr> <tr> <td>04 = Torque current</td> <td>13 = <i>Reserved</i></td> <td>23 = Actual freq. with slip <small>(SW V2.0 and above)</small></td> </tr> <tr> <td>05 = State digital-IO</td> <td>14 = <i>Reserved</i></td> <td>24 = Act. freq. with slip <small>(SW V2.0 and above)</small></td> </tr> <tr> <td>06 = <i>Reserved</i></td> <td>15 = <i>Reserved</i></td> <td>53 = ... 57 <i>Reserved</i></td> </tr> <tr> <td>07 = <i>Reserved</i></td> <td>16 = <i>Reserved</i></td> <td></td> </tr> <tr> <td>08 = Set point frequency</td> <td>17 = Value analog input 1</td> <td></td> </tr> <tr> <td></td> <td>18 = Value analog input 2</td> <td></td> </tr> </table> <p>NOTE: For details regarding the processing of setpoints and actual values, please refer to Section 8.7.</p>				00 = Off	09 = Error code	19 = Frequency master value	01 = Actual frequency	10 = <i>Reserved</i>	20 = Setpoint freq. after ramp	02 = Actual speed	11 = <i>Reserved</i>	21 = Actual freq. w/o slip	03 = Electricity	12 = BusIO Out Bits 0-7	22 = Speed encoder	04 = Torque current	13 = <i>Reserved</i>	23 = Actual freq. with slip <small>(SW V2.0 and above)</small>	05 = State digital-IO	14 = <i>Reserved</i>	24 = Act. freq. with slip <small>(SW V2.0 and above)</small>	06 = <i>Reserved</i>	15 = <i>Reserved</i>	53 = ... 57 <i>Reserved</i>	07 = <i>Reserved</i>	16 = <i>Reserved</i>		08 = Set point frequency	17 = Value analog input 1			18 = Value analog input 2	
00 = Off	09 = Error code	19 = Frequency master value																																
01 = Actual frequency	10 = <i>Reserved</i>	20 = Setpoint freq. after ramp																																
02 = Actual speed	11 = <i>Reserved</i>	21 = Actual freq. w/o slip																																
03 = Electricity	12 = BusIO Out Bits 0-7	22 = Speed encoder																																
04 = Torque current	13 = <i>Reserved</i>	23 = Actual freq. with slip <small>(SW V2.0 and above)</small>																																
05 = State digital-IO	14 = <i>Reserved</i>	24 = Act. freq. with slip <small>(SW V2.0 and above)</small>																																
06 = <i>Reserved</i>	15 = <i>Reserved</i>	53 = ... 57 <i>Reserved</i>																																
07 = <i>Reserved</i>	16 = <i>Reserved</i>																																	
08 = Set point frequency	17 = Value analog input 1																																	
	18 = Value analog input 2																																	

P503	Master function output (Master function output)		S													
0 ... 5 { 0 }	<p>For master-slave applications this parameter specifies on which bus system the master transmits the control word and the master values (P502) for the slave. On the slave, parameters (P509), (P510), (P546 ...) define the source from which the slave obtains the control word and the master values from the master and how these are to be processed by the slave.</p> <hr/> <table border="0"> <tr> <td>0 = Off:</td> <td><u>no output of control word</u> and master values.</td> </tr> <tr> <td>1 = USS:</td> <td>output of control words and master values to USS.</td> </tr> <tr> <td>2 = CAN:</td> <td>output of control words and master values to CAN (up to 250 kBaud).</td> </tr> <tr> <td>3 = CANopen:</td> <td>output of control words and master values to CANopen.</td> </tr> <tr> <td>4 = System bus active:</td> <td>no output of control word and master values, however via the ParameterBox or NORD CON, all participants which are set to System bus active are visible.</td> </tr> <tr> <td>5 = CANopen+Sys.bus active:</td> <td>output of control word and master values on CAN open via the ParameterBox or NORD CON, all participants which are set to system bus active are visible.</td> </tr> </table>				0 = Off:	<u>no output of control word</u> and master values.	1 = USS:	output of control words and master values to USS.	2 = CAN:	output of control words and master values to CAN (up to 250 kBaud).	3 = CANopen:	output of control words and master values to CANopen.	4 = System bus active:	no output of control word and master values, however via the ParameterBox or NORD CON, all participants which are set to System bus active are visible.	5 = CANopen+Sys.bus active:	output of control word and master values on CAN open via the ParameterBox or NORD CON, all participants which are set to system bus active are visible.
0 = Off:	<u>no output of control word</u> and master values.															
1 = USS:	output of control words and master values to USS.															
2 = CAN:	output of control words and master values to CAN (up to 250 kBaud).															
3 = CANopen:	output of control words and master values to CANopen.															
4 = System bus active:	no output of control word and master values, however via the ParameterBox or NORD CON, all participants which are set to System bus active are visible.															
5 = CANopen+Sys.bus active:	output of control word and master values on CAN open via the ParameterBox or NORD CON, all participants which are set to system bus active are visible.															

P504	Pulse frequency (Pulse frequency)		S	
3.0 ... 16.3 kHz { 6.0 / 4.0 }	<p>The internal pulse frequency for controlling the power unit can be changed with this parameter. A higher setting reduces motor noise, but leads to increased EMC emissions and reduction of the possible motor nominal torque.</p> <p>NOTE: The best possible degree of interference suppression for the device is adhered to by using the default value and taking the wiring directives into consideration.</p> <p>NOTE: Raising the pulse frequency leads to a reduction of the possible output current, depending on the time (I^2t curve). When the temperature warning limit (C001) is reached, the pulse frequency is gradually lowered to the default value. If the inverter temperature drops by a sufficient amount, the pulse frequency is increased to the original value.</p> <p>NOTE: <i>Setting 16.1:</i> The automatic adaptation of the pulse frequency is activated with this setting. When doing this, the frequency inverter permanently determines the maximum possible pulse frequency taking different influential factors into consideration such as the heat sink temperature or an overcurrent warning</p> <p>NOTE: In case of overload of the frequency inverter, the pulse frequency is reduced automatically, depending on the instantaneous degree of overload, in order to prevent an overcurrent shut-down (see also P537).</p> <p>However, the use of a sine wave filter requires a constant pulse frequency at all times, as otherwise "Module error" (E4.0) shut-downs will be triggered.</p> <p>The necessary constant pulse frequencies are selected with the following settings: <i>Setting 16.2:</i> 6 kHz <i>Setting 16.3:</i> 8 kHz</p> <p>NB: With these settings, short circuits at the output which occur before enabling may possibly not be detected correctly.</p>			
P505	Abs. minimum frequency (Absolute minimum frequency)		S	P
0.0 ... 10.0 Hz { 2.0 }	<p>Specifies the frequency value that cannot be undershot by the FI. If the setpoint is less than the abs. minimum frequency, the FI switches off or switches to 0.0Hz.</p> <p>At the absolute minimum frequency, braking control (P434) and the setpoint delay (P107) are actuated. If a setting value of "Zero" is selected, the brake relay does not switch during reversing.</p> <p>When controlling lift equipment without speed feedback, this value should be set to a minimum of 2Hz. From 2Hz, the current control of the FI operates and a connected motor can supply sufficient torque.</p> <p>NOTE: Output frequencies of < 4.5 Hz lead to current limitation (please see chapter 8.4 "Reduced output power").</p>			

P506	Automatic error acknowledgement <i>(Automatic error acknowledgement)</i>		S	
0 ... 7 { 0 }	<p>In addition to the manual error acknowledgement, an automatic one can also be selected.</p> <p>0 = No automatic error acknowledgement.</p> <p>1 ... 5 = Number of permissible automatic error acknowledgements within one mains-on cycle. After mains off and switch on again, the full amount is again available.</p> <p>6 = Always: an error message will always be acknowledged automatically if the cause of the error is no longer present.</p> <p>7 = Via Deactivate enable: acknowledgement is only possible using the OK / ENTER key or by mains switch-off. No acknowledgement is implemented by removing the enable!</p> <p>NOTE: If (P428) is parameterised to "ON", parameter (P506) "Automatic error acknowledgement" must not be parameterised to setting 6 "Always" as otherwise the device or system is endangered due to the possibility of continuous restarting in the case of an active error (e.g. short-circuit to earth / short circuit).</p>			
P507	PPO-Type <i>(PPO-Type)</i>			
1 ... 4 { 1 }	<p>This parameter can only be used with the technology unit Profibus, DeviceNet or InterBus. See also the relevant section of the corresponding supplementary BUS manual.</p>			
P508	Profibus address <i>(Profibus address)</i>			
1 ... 126 { 1 }	<p>Profibus address, only with the technology unit Profibus See also the additional description for the Profibus control BU 0020</p>			
P509	Source Control Word <i>(Source control word)</i>			
0 ... 10 { 0 }	<p>Selection of the interface via which the FI is controlled.</p> <p>0 = Control terminals or keyboard control ** with the ControlBox (if P510=0), the ParameterBox (not ext. p-box) or via BUS I/O Bits.</p> <p>1 = Only control terminals , the FI can only be controlled via the digital and analog inputs or via the bus I/O Bits.</p> <p>2 = USS control word *, the control signals (enable, direction of rotation, ...) are transferred via the RS485 interface. The setpoint is transferred via the analog input or the fixed frequencies. This setting should also be selected if communication via <u>Modbus RTU</u> is intended. The frequency inverter automatically detects whether this is a USS protocol or a Modbus protocol.</p> <p>3 = CAN control word *</p> <p>4 = Profibus control word *</p> <p>5 = InterBus control word *</p> <p>6 = CANopen control word *</p> <p>7 = DeviceNet control word *</p> <p>8 = Ethernet TU*** control word*</p> <p>9 = CAN Broadcast *</p> <p>10 = CANopen Broadcast *</p>			
		<p>NOTE: For details about the respective Bus systems please refer to the respective Options descriptions. www.nord.com -</p>		
		<p>*) Keyboard control (ControlBox, ParameterBox, PotentiometerBox) is blocked, parameterisation is still possible.</p> <p>**) If the communication during keyboard control is interrupted (time out 0.5 sec), the FI will block without an error message.</p> <p>***) The Ethernet TU setting must be used for all NORD Ethernet-based bus systems (e.g.: EtherCAT: SK TU3-ECT, PROFINET: SK TU3-PNT).</p>		
	Note:	<p>Parameterisation of a frequency inverter via a field bus connection requires parameter (P509) "Control Terminals" to be set to the appropriate bus system</p>		

P510	[-01] Setpoint source [-02] (Setpoint source)	S																				
0 ... 10 { all 0 }	<p>Selection of the setpoint source to be parameterised.</p> <p style="text-align: center;"> [-01] = Main setpoint source [-02] = Auxiliary setpoint source </p> <hr/> <p>Selection of the interface via which the FI receives the setpoint.</p> <table style="width: 100%; border: none;"> <tr> <td style="width: 50%; vertical-align: top;"> <p>0 = Auto (=P509): The source of the auxiliary setpoint is automatically derived from the setting in the parameter P509 >Interface<</p> <p>1 = Control terminals, digital and analog inputs control the frequency, including fixed frequencies</p> <p>2 = USS (or Modbus RTU)</p> <p>3 = CAN</p> </td> <td style="width: 50%; vertical-align: top;"> <p>4 = Profibus</p> <p>5 = InterBus</p> <p>6 = CANopen</p> <p>7 = DeviceNet</p> <p>8 = Ethernet TU</p> <p>9 = CAN Broadcast</p> <p>10 = CANopen Broadcast</p> </td> </tr> </table>			<p>0 = Auto (=P509): The source of the auxiliary setpoint is automatically derived from the setting in the parameter P509 >Interface<</p> <p>1 = Control terminals, digital and analog inputs control the frequency, including fixed frequencies</p> <p>2 = USS (or Modbus RTU)</p> <p>3 = CAN</p>	<p>4 = Profibus</p> <p>5 = InterBus</p> <p>6 = CANopen</p> <p>7 = DeviceNet</p> <p>8 = Ethernet TU</p> <p>9 = CAN Broadcast</p> <p>10 = CANopen Broadcast</p>																	
<p>0 = Auto (=P509): The source of the auxiliary setpoint is automatically derived from the setting in the parameter P509 >Interface<</p> <p>1 = Control terminals, digital and analog inputs control the frequency, including fixed frequencies</p> <p>2 = USS (or Modbus RTU)</p> <p>3 = CAN</p>	<p>4 = Profibus</p> <p>5 = InterBus</p> <p>6 = CANopen</p> <p>7 = DeviceNet</p> <p>8 = Ethernet TU</p> <p>9 = CAN Broadcast</p> <p>10 = CANopen Broadcast</p>																					
P511	USS baud rate <i>(USS baud rate)</i>	S																				
0 ... 8 { 3 }	<p>Setting of the transfer rate (transfer speed) via the RS485 interface. All bus participants must have the same baud rate setting.</p>																					
	<table style="margin-left: auto; margin-right: auto;"> <tr> <td>0 =</td> <td>4,800 Baud</td> <td>4 =</td> <td>57,600 Baud</td> </tr> <tr> <td>1 =</td> <td>9,600 Baud</td> <td>5 =</td> <td>115,200 Baud</td> </tr> <tr> <td>2 =</td> <td>19,200 Baud</td> <td>6 =</td> <td>187,750 Baud</td> </tr> <tr> <td>3 =</td> <td>38,400 Baud</td> <td>7 =</td> <td>230,400 Baud</td> </tr> <tr> <td></td> <td></td> <td>8 =</td> <td>460,800 Baud</td> </tr> </table>	0 =	4,800 Baud	4 =	57,600 Baud	1 =	9,600 Baud	5 =	115,200 Baud	2 =	19,200 Baud	6 =	187,750 Baud	3 =	38,400 Baud	7 =	230,400 Baud			8 =	460,800 Baud	<i>SK 54xE and above:</i>
0 =	4,800 Baud	4 =	57,600 Baud																			
1 =	9,600 Baud	5 =	115,200 Baud																			
2 =	19,200 Baud	6 =	187,750 Baud																			
3 =	38,400 Baud	7 =	230,400 Baud																			
		8 =	460,800 Baud																			
	<p>NOTE: For communication via Modbus a transfer rate of maximum 38400 Baud must be set.</p>																					
P512	USS address <i>(USS address)</i>																					
0 ... 30 { 0 }	<p>Setting of the FI bus address for USS communication.</p>																					
P513	Telegram time-out <i>(Telegram time out)</i>	S																				
-0.1 / 0.0 / 0.1 ... 1000 s { 0.0 }	<p>Monitoring function of the active bus interface. Following receipt of a valid telegram, the next one must arrive within the set period. Otherwise the FI reports an error and switches off with the error message E010 >Bus Time Out<.</p> <p>0.0 = Off: Monitoring is switched off.</p> <p>-0.1 = No error: Even if communication between BusBox and FI is interrupted (e.g. 24V error, Box removed, etc.), the FI will continue to operate unchanged.</p>																					
	<p>NOTE: SK 511E – SK 535E: If there is communication with an Ethernet module via the system bus (CANopen), the monitoring time should be at least 0.3 sec. Reason: When the system bus is active, communication is only carried out as necessary, however at the latest every 250 ms.</p>																					
	<p>NOTE: The process data channels for USS, CAN/CANopen and CANopen Broadcast are monitoring independently of each other. The decision concerning which channel to monitor is made by means of the setting in parameters P509 and P510.</p> <p>For example, in this way it is possible to register the interruption of a CAN Broadcast communication, although the FI is still communicating with a Master via CAN.</p>																					

P514	CAN baud rate (CAN baud rate)			
0 ... 7 { 4 }	Used to set the transfer rate (transfer speed) via the CANbus interface. All bus participants must have the same baud rate setting. With the use of the CANopen technology unit, settings from this parameter are only valid if the <i>BAUD</i> rotary coding switch on the technology unit has been set to PGM . 0 = 10 kBaud 3 = 100 kBaud 6 = 500 kBaud 1 = 20 kBaud 4 = 125 kBaud 7 = 1 MBaud * 2 = 50 kBaud 5 = 250 kBaud (for test purposes only)			
				*) Reliable operation cannot be guaranteed
	i Information		Data takeover	
			The baud rate is only read after a Power On, a Reset Node message or a Power On of the 24V bus supply.	
P515	CAN address (CAN address)			
0 ... 255 { all 50 }	Setting of the basic CANbus address for CAN and CANopen. With the use of the CANopen technology unit, settings from this parameter are only valid if the <i>BAUD</i> rotary coding switch on the technology unit has been set to PGM .			
	i Information		Data takeover	
			The baud rate is only read after a Power On, a Reset Node message or a Power On of the 24V bus supply.	
	From software version 1.6 and above, this can be set in three levels: [-01] = Slave address , Receipt address for CAN and CANopen (as before) [-02] = Broadcast slave address , Broadcast – receipt address for CANopen (Slave) [-03] = Master address , Broadcast – Transmission address for CANopen (Master)			
P516	Skip frequency 1 (Skip frequency 1)		S	P
0.0 ... 400.0 Hz { 0.0 }	The output frequency around the frequency value (P517) set here is not shown. This range is transmitted with the set brake and acceleration ramp; it cannot be continuously supplied to the output. Frequencies below the absolute minimum frequency should not be set. 0 = Skip frequency inactive			
P517	Skip freq. area 1 (Skip frequency area 1)		S	P
0.0 ... 50.0 Hz { 2.0 }	Skip range for the >Skip frequency 1< P516. This frequency value is added and subtracted from the skip frequency. Skip frequency range 1: P516 - P517 ... P516 + P517			

P518	Skip frequency 2 (Skip frequency 2)		S	P
0.0 ... 400.0 Hz { 0.0 }	The output frequency around the set frequency value (P519) is skipped. This range is transmitted with the set brake and acceleration ramp; it cannot be continuously supplied to the output. Frequencies below the absolute minimum frequency should not be set. 0 = Skip frequency inactive			
P519	Skip freq. area 2 (Skip frequency area 2)		S	P
0.0 ... 50.0 Hz { 2.0 }	Skip range for the >Skip frequency 2< P518. This frequency value is added and subtracted from the skip frequency. Skip frequency range 2: P518 - P519 ... P518 + P519			
P520	Flying start (Flying start)		S	P
0 ... 4 { 0 }	This function is required to connect the FI to already rotating motors, e.g. in fan drives. Motor frequencies >100Hz are only picked up in speed controlled mode (Servo mode P300 = ON). 0 = Switched off, no flying start. 1 = Both directions, the FI looks for a speed in both directions. 2 = Setpoint value direction, searches only in the direction of the setpoint val. which is present. 3 = Both directions after failure, as for { 1 }, however only after mains failure or fault 4 = Setpoint direction after fail, as for { 2 }, however only after mains failure or fault NOTE: For physical reasons, the flying start circuit only operates above 1/10 of the nominal motor frequency (P201), however, not below <u>10Hz</u> .			
		Example 1	Example 2	
(P201)		50Hz	200Hz	
f=1/10*(P201)		f=5Hz	f=20Hz	
Comparison of f with f_{min} with: $f_{min} = 10\text{Hz}$		5Hz < 10Hz	20Hz < 10Hz	
Result f_{Fang}=		The flying start circuit functions above $f_{Fang}=10\text{Hz}$.	The flying start circuit functions above $f_{Fang}=20\text{Hz}$.	
NOTE:	PMSM: The catch function automatically determines the direction of rotation. The device therefore behaves in an identical way to function 1 with the setting for function 2. The device behaves in an identical way to function 3 with the setting for function 4. In CFC closed loop operation, the catch circuit can only be executed if the rotor position is known in relation to the incremental encoder. For this purpose, the motor can initially not rotate when it is switched on for the first time after a "mains on" of the device.			
NOTE:	PMSM: The flying restart does not function if fixed pulse frequencies (setting 16.2 and 16.3) are used in P504 .			
P521	Fly. start resol. (Flying start resolution)		S	P
0.02... 2.50 Hz { 0.05 }	Using this parameter, the flying start circuit search increment size can be adjusted. Values that are too large affect accuracy and causes the FI to cut out with an overcurrent message. If the values are too small, the search time is greatly extended.			

P522		Fly. start offset (Flying start offset)		S	P
-10.0 ... 10.0 Hz { 0.0 }		A frequency value that can be added to the frequency value found, e.g. to remain in the motor range and so avoid the generator range and therefore the chopper range.			
P523		Factory setting (Factory setting)			
0 ... 2 { 0 }		By selecting the appropriate value and confirming it with the ENTER key, the selected parameter range is entered in the factory setting. Once the setting has been made, the value of the parameter returns automatically to 0. 0 = No change: Does not change the parameterisation. 1 = Load factory settings: The complete parameterisation of the FI reverts to the factory setting. All originally parameterised data are lost. 2 = Factory settings without bus: All parameters of the frequency inverter <u>with the exception of</u> the bus parameter, are reset to the factory setting.			
P525	[-01] ... [-03]	Load control max (Load monitoring maximum value)		S	P
1 ... 400 % / 401 { all 401 }		Selection of up to 3 auxiliary values: [-01] = Auxiliary value 1 [-02] = Auxiliary value 2 [-03] = Auxiliary value 3			
		Maximum load torque value. Setting of the upper limit of load monitoring. Up to 3 values can be specified. Prefixes are not taken into account, only the integer values are processed (motor / generator torque, right/left rotation). The array elements [-01], [-02] and [-03] of parameters (P525) ... (P527), or the entries which are made there always belong together. 401 = OFF Means that the function is switched off. No monitoring is performed. This is also the basic setting for the FI.			
P526	[-01] ... [-03]	Load control min (Load monitoring, minimum value)		S	P
0 ... 400 % { all 0 }		Selection of up to 3 auxiliary values: [-01] = Auxiliary value 1 [-02] = Auxiliary value 2 [-03] = Auxiliary value 3			
		Minimum load torque. Setting of the lower limit value of load monitoring. Up to 3 values can be specified. Prefixes are not taken into account, only the integer values are processed (motor / generator torque, right/left rotation). The array elements [-01], [-02] and [-03] of parameters (P525) ... (P527), or the entries which are made there always belong together. 0 = OFF Means that the function is switched off. No monitoring is performed. This is also the basic setting for the FI.			

P527	[-01] ... [-03]	Load control freq. (<i>Load monitoring frequency</i>)		S	P
0.0 ... 400.0 Hz { all 25.0 }	Selection of up to 3 auxiliary values: [-01] = Auxiliary value 1 [-02] = Auxiliary value 2 [-03] = Auxiliary value 3				
Auxiliary frequency values Definition of up to 3 frequency points, which define the monitoring range for load monitoring. The auxiliary frequency values do not need to be entered in order of size. Prefixes are not taken into account, only the integer values are processed (motor / generator torque, right/left rotation). The array elements [-01], [-02] and [-03] of parameters (P525) ... (P527), or the entries which are made there always belong together.					
P528		Load control delay (<i>Load monitoring delay</i>)		S	P
0.10 ... 320.00 s { 2.00 }	Parameter (P528) defines the delay time for which an error message ("E12.5") is suppressed on infringement of the defined monitoring range ((P525) ... (P527)). A warning ("C12.5") is triggered after half of this time has elapsed. According to the selected monitoring mode (P529) an error message can also be generally suppressed.				
P529		Mode Load control (<i>Load monitoring mode</i>)		S	P
0 ... 3 { 0 }	The reaction of the frequency inverter to an infringement of the defined monitoring range ((P525) ... (P527)) after the elapse of the delay time (P528) is specified by parameter (P529). 0 = Fault and warning. After the elapse of the time defined in (P528), an infringement of the monitoring range produces a fault ("E12.5"). A warning ("C12.5") is given after the elapse of half of this time. 1 = Warning. After the elapse of half of the time defined in (P528) and infringement of the monitoring range produces a warning ("C12.5"). 2 = Error and warning, constant travel, "Error and warning during constant travel", as for setting "0" however monitoring is inactive during acceleration phases. 3 = Warning constant travel, "Only warning during constant travel", as for setting "1", however monitoring is inactive during acceleration phases.				

P525 ... P529 Load monitoring

With the load monitoring, a range can be specified within which the load torque may change depending on the output frequency. There are three auxiliary values for the maximum permissible torque and three auxiliary values for the minimum permissible torque. A frequency is assigned to each of these auxiliary values. No monitoring is carried out below the first and above the third frequency. In addition, the monitoring can be deactivated for minimum and maximum values. As standard, monitoring is deactivated.

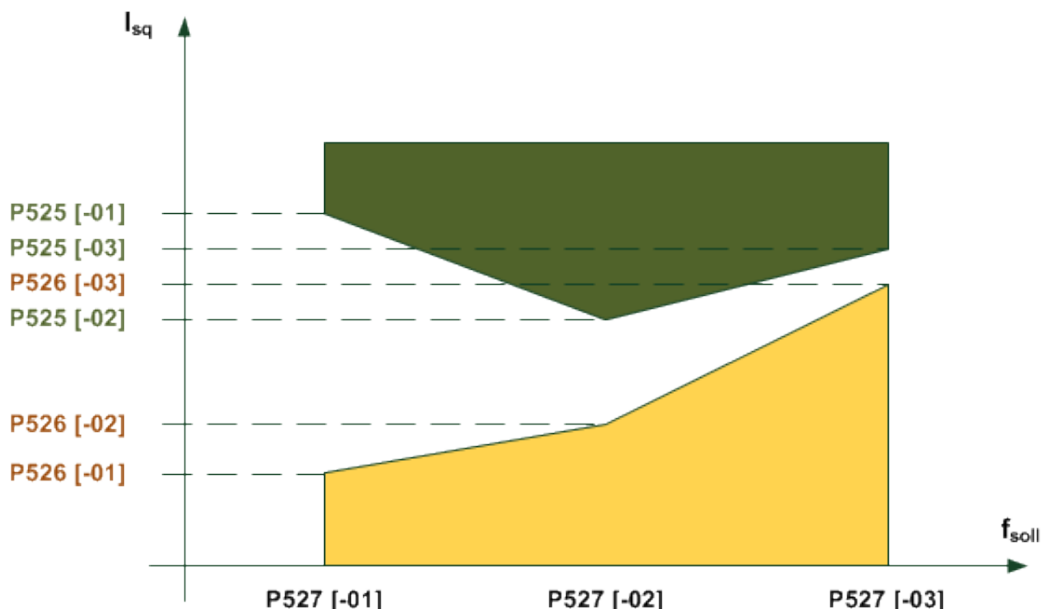

The time after which a fault is triggered can be set with parameter (P528). If the permissible range is exceeded (Example diagram: Infringement of the area marked in yellow or green), the error message **E12.5** is generated unless parameter (P529) does not suppress the triggering of an error.

A warning **C12.5** is always given after the elapse of half of the set error triggering time (P528). This also applies if a mode is selected for which no fault message is generated. If only a maximum or minimum value is to be monitored, the other limit must be deactivated or must remain deactivated. The torque current and not the calculated torque is used as the reference value. This has the advantage that monitoring in the "non field weakened range" without servo mode is usually more accurate. Naturally however, it cannot display more than the physical torque in the weakened field range.

All parameters depend on parameter sets. No differentiation is made between motor and generator torque, therefore the value of the torque is considered. As well as this, there is no differentiation between "left" and "right" running. The monitoring is therefore independent of the prefix of the frequency. There are four different load monitoring modes (P529).

The frequencies, and the minimum and maximum values belong together within the various array elements. The frequencies do not need to be sorted according to their magnitude in the elements 0, 1 and 2, as the frequency inverter does this automatically.

<p>P533</p>	<p>Factor I²t-Motor (Factor I²t-Motor)</p>		<p>S</p>	
<p>50 ... 150 % { 100 }</p>	<p>The motor current for the I²t motor monitoring P535 can be weighted with the parameter P533. Larger factors permit larger currents.</p>			

P534	[-01] Torque disconn. limit [-02] (<i>Torque disconnection limit</i>)		S	P
-------------	--	--	----------	----------

0 ... 400 % / 401
{ all 401 }

Via this parameter both the **drive** [-01] and the **generator** [-02] switch-off value can be adjusted. If 80% of the set value is reached, a warning status is set. At 100% switch-off is performed with an error message.

Error 12.1 is given on exceeding the drive switch-off limit and 12.2 on exceeding the generator switch-off limit.

[01] = drive switch-off limit

[02] = generator switch-off limit

401 = OFF means that this function has been disabled.

P535	I²t Motor (<i>I²t Motor</i>)			
-------------	--	--	--	--

0 ... 24
{ 0 }

The motor temperature is calculated depending on the output current, the time and the output frequency (cooling). If the temperature limit value is reached then switch off occurs and error message E002 (motor overheating) is output. Possible positive or negative acting ambient conditions cannot be taken into account here.

The I²t motor function can be set in a differentiated manner. 8 characteristic curves with three different triggering times (<5 s, <10 s and <20 s) can be set. The trigger times are based on classes 5, 10 and 20 for semiconductor switching devices. The recommended setting for standard applications is **P535=5**.

All curves run from 0 Hz to half of the nominal motor frequency (P201). The full nominal current is available from half of the nominal frequency upwards.

With multi-motor operation the monitoring must be disabled.

0 = I²t Motor off: Monitoring is inactive

Switch-off class 5, 60s at 1.5x I _N		Switch-off class 10, 120s at 1.5x I _N		Switch-off class 20, 240s at 1.5x I _N	
I _N at 0Hz	P535	I _N at 0Hz	P535	I _N at 0Hz	P535
100%	1	100%	9	100%	17
90%	2	90%	10	90%	18
80%	3	80%	11	80%	19
70%	4	70%	12	70%	20
60%	5	60%	13	60%	21
50%	6	50%	14	50%	22
40%	7	40%	15	40%	23
30%	8	30%	16	30%	24

NOTE: Shut-off classes 10 and 20 are provided for applications with heavy starting. When using these shut-off classes, it must be ensured that the FI has a sufficiently high overload capacity.

0 ... 1
{ 0 }

Up to and including software version 1.5 R1, the following applies:

0 = Switched off

1 = Switched on (equivalent to setting 5 (see above))

P536	Current limit (<i>Current limit</i>)		S	
-------------	--	--	----------	--

0.1 ... 2.0 / 2.1
(x nominal current of FI)

The inverter output current is limited to the set value. If this limit value is reached, the inverter reduces the actual output frequency.

Multiplier with the inverter nominal current, gives the limit value

{ 1.5 }

2.1 = OFF represents the disabling of this limit value.

P537	Pulse disconnection (Pulse disconnection)		S	
10 ... 200 % / 201 { 150 }	<p>This function prevents rapid shutdown of the FI according to the load. With the pulse switch-off enabled, the output current is limited to the set value. This limitation is implemented by brief switching off of individual output stage transistors, the actual output frequency remains unchanged.</p>			
<p>10...200 % = Limit value in relation to nominal FI current</p> <p>201 = The function is so to speak disabled, the FI supplies the maximum possible current. However, at the current limit the pulse switch-off can still be active.</p>				
<p>NOTE: The value set here can be undershot by a smaller value in P536. With smaller output frequencies (<4.5 Hz) or higher pulse frequencies (>6 kHz or 8 kHz, P504) the pulse switch-off can be undershot by the power reduction (please see chapter 8.4 "Reduced output power").</p> <p>NOTE: If the pulse switch-off is disabled (P537=201) and a high pulse frequency is selected in parameter P504, the FI automatically reduces the pulse frequency when the power limit is reached. If the load on the FI is reduced again, the pulse frequency increases back to the original value.</p>				
P538	Check input voltage (Mains voltage monitoring)		S	
0 ... 4 { 3 }	<p>For reliable operation of the inverter the power supply must meet a certain quality. If there is a brief interruption of a phase or the voltage supply sinks below a particular limit value, the inverter will output an error.</p>			
<p>Under certain operating conditions, it may be necessary to suppress this error message. In this case, the input monitoring can be modified.</p> <p>0 = Switched off: No monitoring of the supply voltage.</p> <p>1 = Phase error: an error message is only produced by phase errors.</p> <p>2 = Mains voltage: an error message is only produced by a low voltage.</p> <p>3 = Phase err. + mains voltage: A phase error or undervoltage produce an error message.</p> <p>4 = DC supply: The input voltage is fixed at 480V for the direct supply of direct current. Phase error and low mains voltage monitoring are deactivated.</p> <p>NOTE: Operation with an impermissible mains voltage can destroy the frequency inverter! With 1/3~230 V or 1~115 V devices, the phase error monitoring does not function!</p>				
P539	Output monitoring (Output monitoring)		S	P
0 ... 3 { 0 }	<p>This protective function monitors the output current at the U-V-W terminals and checks for plausibility. In cases of error, the error message E016 is output.</p>			
<p>0 = Disabled: Monitoring is not active.</p> <p>1 = Only motor phases: The output current is measured and checked for symmetry. If an imbalance is present, the FI switches off and outputs the error message E016.</p> <p>2 = Only magnetisation: At the moment the FI is switched on, the level of the excitation current (field current) is checked. If insufficient excitation current is present, the FI switches off with the error message E016. A motor brake is not released in this phase.</p> <p>3 = Motor phase + Magnet: Monitoring of the motor phases and magnetisation as in 1 and 2 are combined.</p>				
<p>NOTE: This function can be used as an additional protective function for lifting applications, but is not permissible on its own as protection for persons.</p>				

P540	Mode phase sequence (Rotation direction mode)		S	P
0 ... 7 { 0 }	<p>For safety reasons this parameter can be used to prevent a rotation direction reversal and therefore the incorrect rotation direction.</p> <p>This function does not operate with active position control (SK 53xE and above, P600 ≠ 0).</p> <p>0 = No restriction, no restriction of the direction of rotation</p> <p>1 = Dir. key disabled, the direction key of the ControlBox SK TU3-CTR is disabled.</p> <p>2 = CW only*, only clockwise direction is possible. The selection of the "incorrect" rotation direction leads to the output of the minimum frequency P104 with the field of rotation R.</p> <p>3 = CCW only*, only counter-clockwise direction is possible. The selection of the "incorrect" rotation direction leads to the output of the minimum frequency P104 with the field of rotation L.</p> <p>4 = Enable direction only, rotation direction is only possible according to the enable signal, otherwise 0Hz.</p> <p>5 = CW only monitored *, <i>only the clockwise direction is monitored</i>, only a clockwise field rotation is possible. The selection of the "incorrect" rotation direction leads to the FI switching off (control block). If necessary, an adequately large setpoint value (>f_{min}) must be observed.</p> <p>6 = CCW only monitored: *, <i>only the counter-clockwise direction is monitored</i>, only a counter-clockwise field rotation is possible. The selection of the "incorrect" rotation direction leads to the FI switching off (control block). If necessary, an adequately large setpoint value (>f_{min}) must be observed.</p> <p>7 = Only enabled direction monitored, <i>only the enabled direction is monitored</i>, rotation is only possible according to the enable signal, otherwise the FI is switched off.</p> <p style="text-align: right;">*) Applies to keyboard (SK TU3-) and control terminal actuation, in addition, the direction key on the ControlBox is blocked.</p>			

P541	Set relays (Set relays and digital outputs)		S															
0000 ... 3FFF(hex) { 0000 }	<p>This function provides the opportunity to control the relay and the digital outputs independently of the frequency inverter status. To do this, the relevant output must be set to the function "value of P541".</p> <p>This function can either be used manually or in combination with a bus control.</p> <table style="width: 100%; border: none;"> <tr> <td style="width: 33%;">Bit 0 = Output 1 (K1)</td> <td style="width: 33%;">Bit 5 = Output 5 (DOUT3) <i>(SK 540E and above)</i></td> <td style="width: 33%;">Bit 9 = BusIO Out Bit 1</td> </tr> <tr> <td>Bit 1 = Output 2 (K2)</td> <td>Bit 6 = reserved</td> <td>Bit 10 = BusIO Out Bit 2</td> </tr> <tr> <td>Bit 2 = Output 3 (DOUT1)</td> <td>Bit 7 = reserved</td> <td>Bit 11 = BusIO Out Bit 3</td> </tr> <tr> <td>Bit 3 = Output 4 (DOUT2)</td> <td>Bit 8 = BusIO Out Bit 0</td> <td>Bit 12 = BusIO Out Bit 4</td> </tr> <tr> <td>Bit 4 = Dig. AOut 1 (Analog output 1)</td> <td></td> <td>Bit 13 = BusIO Out Bit 5</td> </tr> </table>	Bit 0 = Output 1 (K1)	Bit 5 = Output 5 (DOUT3) <i>(SK 540E and above)</i>	Bit 9 = BusIO Out Bit 1	Bit 1 = Output 2 (K2)	Bit 6 = reserved	Bit 10 = BusIO Out Bit 2	Bit 2 = Output 3 (DOUT1)	Bit 7 = reserved	Bit 11 = BusIO Out Bit 3	Bit 3 = Output 4 (DOUT2)	Bit 8 = BusIO Out Bit 0	Bit 12 = BusIO Out Bit 4	Bit 4 = Dig. AOut 1 (Analog output 1)		Bit 13 = BusIO Out Bit 5		
Bit 0 = Output 1 (K1)	Bit 5 = Output 5 (DOUT3) <i>(SK 540E and above)</i>	Bit 9 = BusIO Out Bit 1																
Bit 1 = Output 2 (K2)	Bit 6 = reserved	Bit 10 = BusIO Out Bit 2																
Bit 2 = Output 3 (DOUT1)	Bit 7 = reserved	Bit 11 = BusIO Out Bit 3																
Bit 3 = Output 4 (DOUT2)	Bit 8 = BusIO Out Bit 0	Bit 12 = BusIO Out Bit 4																
Bit 4 = Dig. AOut 1 (Analog output 1)		Bit 13 = BusIO Out Bit 5																

	Bits 13-12	Bits 11-8	Bits 7-4	Bits 3-0	
Min. value	00 0	0000 0	0000 0	0000 0	Binary hex
Max. value	11 3	1111 F	1111 F	1111 F	Binary hex

- BUS:** The corresponding hex value is written into the parameter, thereby setting the relay and digital outputs.
- ControlBox:** The hexadecimal code is entered directly when the ControlBox is used.
- ParameterBox:** Each individual output can be separately called up in plain text and activated.
- NOTE:** The setting is not saved in the EEPROM and is lost when the frequency inverter is switched off!

P542	Set analog output (Set analog output)		S			
0.0 ... 10.0 V { 0.0 }	<p>The analog output of the FI can be set with this function, independently of the actual operating state. To do this, the relevant analog output must be set to the function "External control" (P418 = 7). This function can either be used manually or in combination with a bus control. The value set here will, once confirmed, be produced at the analog output.</p> <p>NOTE: The setting is not saved in the EEPROM and is lost when the frequency inverter is switched off!</p>					
P543	Actual bus value 1 (Actual bus value 3)		S	P		
0 ... 24 { 1 }	<p>The return value 1 can be selected for bus actuation in this parameter. The possible analog functions can be found in the following table.</p> <p>NOTE: For further details please refer to the manual for the frequency inverter (P418, P543), the relevant BUS operating instructions or BU 0510.</p> <table style="width: 100%; border: none;"> <tr> <td style="width: 50%; vertical-align: top;"> <p>0 = Off</p> <p>1 = Actual frequency</p> <p>2 = Actual speed</p> <p>3 = Current</p> <p>4 = Torque current (100% = P112)</p> <p>5 = Digital IO status ¹</p> <p>6 = ... 7 Reserved</p> <p>8 = Setpoint frequency</p> <p>9 = Error number</p> <p>10 = ... 11 Reserved</p> <p>12 = BusIO Out Bits 0...7</p> </td> <td style="width: 50%; vertical-align: top;"> <p>13 = ... 16 Reserved</p> <p>17 = Value analog input 1</p> <p>18 = Value analog input 2</p> <p>19 = Setpoint frequency master value(P503)</p> <p>20 = Setpoint frequency master value after ramp "Setpoint frequency master value after ramp"</p> <p>21 = Act. freq. without slip master value "Actual frequency without slip master value"</p> <p>22 = Speed encoder (only possible with SK 520E and encoder feedback)</p> <p>23 = Actual frequency with slip, "Actual frequency with slip" (SW V2.0 and above)</p> <p>24 = Master value, actual freq. with slip, "Master value, actual freq. with slip" (SW V2.0 and above)</p> <p>53 = ... 57 Reserved</p> </td> </tr> </table> <p style="text-align: right;">Scaling details: (chapter 8.7)</p>				<p>0 = Off</p> <p>1 = Actual frequency</p> <p>2 = Actual speed</p> <p>3 = Current</p> <p>4 = Torque current (100% = P112)</p> <p>5 = Digital IO status ¹</p> <p>6 = ... 7 Reserved</p> <p>8 = Setpoint frequency</p> <p>9 = Error number</p> <p>10 = ... 11 Reserved</p> <p>12 = BusIO Out Bits 0...7</p>	<p>13 = ... 16 Reserved</p> <p>17 = Value analog input 1</p> <p>18 = Value analog input 2</p> <p>19 = Setpoint frequency master value(P503)</p> <p>20 = Setpoint frequency master value after ramp "Setpoint frequency master value after ramp"</p> <p>21 = Act. freq. without slip master value "Actual frequency without slip master value"</p> <p>22 = Speed encoder (only possible with SK 520E and encoder feedback)</p> <p>23 = Actual frequency with slip, "Actual frequency with slip" (SW V2.0 and above)</p> <p>24 = Master value, actual freq. with slip, "Master value, actual freq. with slip" (SW V2.0 and above)</p> <p>53 = ... 57 Reserved</p>
<p>0 = Off</p> <p>1 = Actual frequency</p> <p>2 = Actual speed</p> <p>3 = Current</p> <p>4 = Torque current (100% = P112)</p> <p>5 = Digital IO status ¹</p> <p>6 = ... 7 Reserved</p> <p>8 = Setpoint frequency</p> <p>9 = Error number</p> <p>10 = ... 11 Reserved</p> <p>12 = BusIO Out Bits 0...7</p>	<p>13 = ... 16 Reserved</p> <p>17 = Value analog input 1</p> <p>18 = Value analog input 2</p> <p>19 = Setpoint frequency master value(P503)</p> <p>20 = Setpoint frequency master value after ramp "Setpoint frequency master value after ramp"</p> <p>21 = Act. freq. without slip master value "Actual frequency without slip master value"</p> <p>22 = Speed encoder (only possible with SK 520E and encoder feedback)</p> <p>23 = Actual frequency with slip, "Actual frequency with slip" (SW V2.0 and above)</p> <p>24 = Master value, actual freq. with slip, "Master value, actual freq. with slip" (SW V2.0 and above)</p> <p>53 = ... 57 Reserved</p>					
P544	Actual bus value 2 (Actual bus value 2)		S	P		
0 ... 24 { 0 }	<p>This parameter is identical to P543. Condition is PPO 2 or PPO 4 type (P507).</p>					
P545	Actual bus value 3 (Actual bus value 3)		S	P		
0 ... 24 { 0 }	<p>This parameter is identical to P543. Condition is PPO 2 or PPO 4 type (P507).</p>					

¹ The assignment of the digital inputs in P543/ 544/ 545 = 5

Bit 0 = DigIn 1	Bit 1 = DigIn 2	Bit 2 = DigIn 3	Bit 3 = DigIn 4
Bit 4 = DigIn 5	Bit 5 = DigIn 6 (SK 520E and above)	Bit 6 = DigIn 7 (SK 520E and above)	Bit 7 = Dig. func. AIN1
Bit 8 = Dig. func. AIN1 AIN2	Bit 9 = DigIn 8 (SK 540E and above)	Bit 10 = DigIn 1, 1.IOE (SK 540E and above)	Bit 11 = DigIn 2, 1.IOE (SK 540E and above)
Bit 12 = Out 1/ MFR1	Bit 13 = Out 2/ MFR2	Bit 14 = Out 3/ DOUT1 (SK 520E and above)	Bit 15 = Out 4/ DOUT2 (SK 520E and above)

P546	Digital Bus setpoint 1 <i>(Function of bus setpoint 1)</i>		S	P
0 ... 55 { 1 }	<p>In this parameter, a function is allocated to the output setpoint 1 during bus actuation. The possible analog functions can be found in the following table.</p> <p>NOTE: For further details please refer to the manual for the frequency inverter (P400, P546), the relevant BUS operating instructions or the manuals BU 0510 / BU0550.</p>			
	<p>0 = Off</p> <p>1 = Setpoint frequency</p> <p>2 = Torque current limit (<i>P112</i>)</p> <p>3 = Actual frequency PID</p> <p>4 = Frequency addition</p> <p>5 = Frequency subtraction</p> <p>6 = Current limit (<i>P536</i>)</p> <p>7 = Maximum frequency (<i>P105</i>)</p> <p>8 = Actual PID frequency limited</p> <p>9 = Actual PID frequency monitored</p> <p>10 = Torque servo mode (<i>P300</i>)</p> <p>11 = Torque precontrol (<i>P214</i>)</p> <p>12 = Reserved</p> <p>13 = Multiplication</p> <p>14 = Process controller actual value</p> <p>15 = Process controller setpoint</p>	<p>16 = Process controller lead</p> <p>17 = BusIO In Bits 0...7</p> <p>18 = Curve travel calculator</p> <p>19 = Set relays, "Output status" (P434/441/450/455=38)</p> <p>20 = Set analog output (P418=31)</p> <p>21 = ... 45 reserved from SK 530E and above → BU 0510</p> <p>46 = Setpoint Torque processreg., "Setpoint torque process controller"</p> <p>47 = reserved from SK 530E and above → BU 0510</p> <p>48 = Motor temperature (<i>SK 540E and above</i>)</p> <p>49 = reserved from SK 540E and above → BU 0510</p> <p>53 = d-correction F process (<i>SK 540E and above</i>)</p> <p>54 = d-correction Torque (<i>SK 540E and above</i>)</p> <p>55 = d-correction F+torque (<i>SK 540E and above</i>)</p> <p>56 = reserved from SK 540E and above → BU 0510</p> <p>57 = reserved from SK 540E and above → BU 0510</p>		
	Scaling details: See Section 8.7			
P547	Digital Bus setpoint 2 <i>(Function of bus setpoint 2)</i>		S	P
0 ... 55 { 0 }	This parameter is identical to P546.			
P548	Digital Bus setpoint 3 <i>(Function of bus setpoint 3)</i>		S	P
0 ... 55 { 0 }	This parameter is identical to P546.			

P549	Pot Box function <i>(PotentiometerBox function)</i>		S																			
0 ... 16 { 0 }	<p>In this parameter, the setpoint of the PotentiometerBox (SK TU3-POT) is assigned with a function. (An explanation can be found in the description of P400.)</p> <p>As of software version 1.7 R0, on setting 4 or 5, the ControlBox or the ParameterBox are also set to function as suppliers of auxiliary setpoints (see Section 4.5).</p> <table border="0"> <tr> <td>0 = Off</td> <td>8 = Actual PID frequency limited</td> </tr> <tr> <td>1 = Setpoint frequency</td> <td>9 = Actual PID frequency monitored</td> </tr> <tr> <td>2 = Torque current limit</td> <td>10 = Servo mode torque</td> </tr> <tr> <td>3 = Actual frequency PID</td> <td>11 = Torque precontrol</td> </tr> <tr> <td>4 = Frequency addition</td> <td>12 = <i>Reserved</i></td> </tr> <tr> <td>5 = Frequency subtraction</td> <td>13 = Multiplication</td> </tr> <tr> <td>6 = Current limit</td> <td>14 = Process controller actual value</td> </tr> <tr> <td>7 = Maximum frequency</td> <td>15 = Process controller setpoint</td> </tr> <tr> <td></td> <td>16 = Process controller lead</td> </tr> </table>	0 = Off	8 = Actual PID frequency limited	1 = Setpoint frequency	9 = Actual PID frequency monitored	2 = Torque current limit	10 = Servo mode torque	3 = Actual frequency PID	11 = Torque precontrol	4 = Frequency addition	12 = <i>Reserved</i>	5 = Frequency subtraction	13 = Multiplication	6 = Current limit	14 = Process controller actual value	7 = Maximum frequency	15 = Process controller setpoint		16 = Process controller lead			
0 = Off	8 = Actual PID frequency limited																					
1 = Setpoint frequency	9 = Actual PID frequency monitored																					
2 = Torque current limit	10 = Servo mode torque																					
3 = Actual frequency PID	11 = Torque precontrol																					
4 = Frequency addition	12 = <i>Reserved</i>																					
5 = Frequency subtraction	13 = Multiplication																					
6 = Current limit	14 = Process controller actual value																					
7 = Maximum frequency	15 = Process controller setpoint																					
	16 = Process controller lead																					

P550	Back up data record <i>(Back up data record)</i>			
0 ... 3 { 0 }	<p>Within the optional ControlBox it is possible to save a data set (parameter set 1 ... 4) of the connected FI. This is saved in a non-volatile memory within the Box, and can therefore be transferred for other SK 5xxE units with the same database version (see P742).</p> <p>0 = No change</p> <p>1 = FI → ControlBox, the dataset is written from the connected FI to the ControlBox.</p> <p>2 = ControlBox → FI, the dataset is written from the ControlBox to the connected FI.</p> <p>3 = FI ↔ ControlBox, the FI dataset is exchanged with the ControlBox dataset. With this variant, no data is lost. It is continuously exchangeable.</p> <p>NOTE: If parameterisation from old FI's need to be loaded into FIs with new software (P707), then the ControlBox must previously be written to by the new FI (P550 = 1). The dataset to be copied from the old FI can then be read out and copied to the new FI.</p>			

P551	Drive profile <i>(Drive profile)</i>		S																				
0 ... 1 { 0 }	<p>According to the option the relevant process data profiles can be activated with this parameter.</p> <table border="1"> <thead> <tr> <th>System</th> <th>CANopen</th> <th>DeviceNet</th> <th>InterBus</th> </tr> </thead> <tbody> <tr> <td>Technology module</td> <td>SK TUx-CAO</td> <td>SK TUx-DEV</td> <td>SK TUx-IBS</td> </tr> <tr> <td>Setting</td> <td></td> <td></td> <td></td> </tr> <tr> <td>0 = OFF =</td> <td colspan="3">USS protocol (Profile "Nord")</td> </tr> <tr> <td>1 = ON =</td> <td>DS402 profile</td> <td>AC Drives profile</td> <td>Drivecom profile</td> </tr> </tbody> </table>	System	CANopen	DeviceNet	InterBus	Technology module	SK TUx-CAO	SK TUx-DEV	SK TUx-IBS	Setting				0 = OFF =	USS protocol (Profile "Nord")			1 = ON =	DS402 profile	AC Drives profile	Drivecom profile		
System	CANopen	DeviceNet	InterBus																				
Technology module	SK TUx-CAO	SK TUx-DEV	SK TUx-IBS																				
Setting																							
0 = OFF =	USS protocol (Profile "Nord")																						
1 = ON =	DS402 profile	AC Drives profile	Drivecom profile																				

 Note

Activation of profiles

This parameter is only **effective for pluggable** technology modules (SK TU3-...).

P552	[-01] CAN master circle [-02] (CAN master cycle time)		S	
-------------	--	--	----------	--

0 ... 100 ms
{ all 0 }

In this parameter, the cycle time for the CAN/CANopen master mode and the CANopen encoder is set (see P503/514/515):

[-01] = CAN Master function, cycle time for CAN/CANopen Master functionality

[-02] = CANopen absolute encoder, cycle time of CANopen absolute encoder

According to the Baud rate set, there are different minimum values for the actual cycle time:

Baud rate	Minimum value tz	Default CAN Master	Default CANopen Abs.
10kBaud	10ms	50ms	20ms
20kBaud	10ms	25ms	20ms
50kBaud	5ms	10ms	10ms
100kBaud	2ms	5ms	5ms
125kBaud	2ms	5ms	5ms
250kBaud	1ms	5ms	2ms
500kBaud	1ms	5ms	2ms
1000kBaud:	1ms	5ms	2ms

The range of values which can be set is between 0 and 100ms. With the setting 0 "Auto" the default value (see table) is used. The monitoring function for the CANopen absolute encoder no longer triggers at 50ms, but rather at 150ms.

P554	Chopper min. threshold <i>(Minimum chopper threshold)</i>		S	
-------------	---	--	----------	--

65 ... 101 %
{ 65 }

The switching threshold of the brake chopper can be influenced with this parameter. An optimized value for numerous applications is set in the factory setting. This parameter can be increased for applications where pulsating energy is returned (crank drives) to minimise brake resistance power dissipation.

An increase in this setting leads to a faster overvoltage switch off of the FI.

The setting **101%** also switches off the brake chopper at the 65% switching threshold. In addition, with this setting, monitoring is also active if the FI has not been enabled. I.e. for example if the link circuit voltage in the FI increases above the threshold in "Standby" status (e.g. due to a mains fault), the brake chopper is activated. However, in case of an FI fault, the brake chopper is generally inactive.

P555	Chopper P limitation <i>(Chopper power limitation)</i>		S	
-------------	--	--	----------	--

5 ... 100 %
{ 100 }

With this parameter it is possible to program a manual (peak) power limit for the brake resistor. The switch-on delay (modulation level) for the chopper can only rise to a certain maximum specified limit. Once this value has been reached, irrespective of the level of the link voltage, the inverter switches off the current to the resistor.

The result would be an overvoltage switch-off of the FI.

The correct percentage value is calculated as follows: $k[\%] = \frac{R * P_{\max BW}}{U_{\max}^2} * 100\%$

R = Resistance of the brake resistor

P_{maxBW} = Momentary peak power of the brake resistor

U_{max} = FI chopper switching threshold

1~ 115/230 V ⇒ 440 V=

3~ 230 V ⇒ 500 V=

3~ 400 V ⇒ 1000 V=

P556	Braking resistor (<i>Brake resistor</i>)		S	
1 ... 400 Ω { 120 }	Value of the brake resistance for the calculation of the maximum brake power to protect the resistor. Once the maximum continuous output (P557) including overload (200% for 60s) is reached, an I ² t limit error (E003.1) is triggered. Further details in P737.			
P557	Brake resistor type (<i>Brake resistor power</i>)		S	
0.00 ... 320.00 kW { 0.00 }	Continuous power (nominal power) of the resistor, to display the actual utilisation in P737. For a correctly calculated value, the correct value must be entered into P556 and P557. 0.00 = Monitoring disabled			
P558	Flux delay (<i>Magnetizing time</i>)		S	P
0 / 1 / 2 ... 500 ms { 1 }	The ISD control can only function correctly if there is a magnetic field in the motor. For this reason, a DC current is applied before starting the motor. The duration depends on the size of the motor and is automatically set in the factory setting of the FI. For time-critical applications, the magnetizing time can be set or deactivated. 0 = Switched off 1 = Automatic calculation 2 ... 500 = Time set in [ms] NOTE: Setting values that are too low can reduce the dynamics and starting torque.			
P559	DC Run-on time (<i>DC Run-on time</i>)		S	P
0.00 ... 30.00 s { 0.50 }	Following a stop signal and the braking ramp, a direct current is briefly applied to the motor to fully bring the drive to a stop. Depending on the inertia, the time for which the current is applied can be set in this parameter. The current level depends on the previous braking procedure (current vector control) or the static boost (linear characteristic).			
P560	Parameter, Saving mode (<i>Saving mode parameter</i>)		S	
0 ... 2 { 1 }	0 = Only in RAM , changes to the parameter settings are no longer saved on the EEPROM. All previously saved settings are retained, even if the FI is disconnected from the mains. 1 = RAM and EEPROM , all parameter changes are automatically written to the EEPROM and remain stored there even if the FI is disconnected from the mains supply. 2 = OFF , no saving in RAM <u>and</u> EEPROM possible (<u>no</u> parameter changes are accepted) NOTE: If BUS communication is used to implement parameter changes, it must be ensured that the maximum number of write cycles (100,000 x) in the EEPROM is not exceeded.			

Positioning

The parameter group P6xx is used to set the POSICON positioning control and is included above the version SK 530E.

A detailed description of these parameters can be found in manual [BU 0510](http://www.nord.com). (www.nord.com)

Information

Parameter	Setting value / Description / Note		Supervisor	Parameter set
P700	[-01] Actual operating status ... [-03] <i>(Actual operating status)</i>			
0.0 ... 25.4	Display of current messages for the present operating status of the frequency inverter such as faults, warnings or the reason why switch-on is disabled (please see chapter 6 "Operating status messages"). [-01] = Present fault , shows the currently active (unacknowledged) fault (please see section "Error messages"). [-02] = Present warning , indicates a current warning message (please see section "Warning messages"). [-03] = Reason for disabled starting , indicates the reason for an active start disable (please see section "Switch-on block messages"). NOTE <i>SimpleBox / ControlBox</i> : the error numbers of the warning messages and faults can be displayed using SimpleBox and ControlBox. <i>ParameterBox</i> : with the ParameterBox the messages are displayed in plain text.. In addition, the reason for a possible disabling of starting can also be displayed. <i>Bus</i> : The display of bus-level error messages is displayed in decimal integer format. The displayed value must be divided by 10 in order to correspond with the correct format. Example: Display: 20 → Error number: 2.0			
P701	[-01] Last fault 1 ... 5 ... [-05] <i>(Last fault 1...5)</i>			
0.0 ... 25.4	This parameter stores the last 5 faults (please see section "Error messages"). The SimpleBox / ControlBox must be used to select the corresponding memory location 1...5- (Array parameter), and confirmed using the OK / ENTER key to read the stored error code.			
P702	[-01] Last frequency error ... [-05] <i>(Last frequency error 1...5)</i>		S	
-400.0 ... 400.0 Hz	This parameter stores the output frequency that was being delivered at the time the fault occurred. The values of the last 5 errors are stored. The SimpleBox / ControlBox must be used to select the corresponding memory location 1...5- (Array parameter), and confirmed using the OK- / ENTER key to read the stored error code.			
P703	[-01] Current last error ... [-05] <i>(Last current error 1...5)</i>		S	
0.0 ... 999.9 A	This parameter stores the output current that was being delivered at the time the fault occurred. The values of the last 5 errors are stored. The SimpleBox / ControlBox must be used to select the corresponding memory location 1...5- (Array parameter), and confirmed using the OK / ENTER key to read the stored error code.			

P704	[-01] ... [-05]	Volt. last error <i>(Last voltage error 1...5)</i>		S	
0 ... 600 V AC	<p>This parameter stores the output voltage that was being delivered at the time the fault occurred. The values of the last 5 errors are stored.</p> <p>The SimpleBox / ControlBox must be used to select the corresponding memory location 1...5- (Array parameter), and confirmed using the OK / ENTER key to read the stored error code.</p>				
P705	[-01] ... [-05]	Last link circuit error <i>(Last link circuit error 1...5)</i>		S	
0 ... 1000 V DC	<p>This parameter stores the link voltage that was being delivered at the time the error occurred. The values of the last 5 errors are stored.</p> <p>The SimpleBox / ControlBox must be used to select the corresponding memory location 1...5- (Array parameter), and confirmed using the OK / ENTER key to read the stored error code.</p>				
P706	[-01] ... [-05]	P set last error <i>(Parameter set, last error 1... 5)</i>		S	
0 ... 3	<p>This parameter stores the parameter set code that was active when the error occurred. Data for the previous 5 faults are stored.</p> <p>The SimpleBox / ControlBox must be used to select the corresponding memory location 1...5- (Array parameter), and confirmed using the OK / ENTER key to read the stored error code.</p>				
P707	[-01] ... [-03]	Software-Version <i>(Software version/ revision)</i>			
0.0 ... 9999.9	<p>This parameter shows the software and revision numbers in the FI. This can be significant when different FIs are assigned the same settings.</p> <p>Array 03 provides information about any special versions of the hardware or software A zero stands for the standard version.</p> <p>... .. [-01] = Version number (Vx.x) [-02] = Revision number (Rx) [-03] = Special version of hardware/software (0.0)</p>				

P708	State of digital in. <i>(Status of digital inputs)</i>		
-------------	--	--	--

000000000 ...
111111111
(binary) (Display with *SK-TU3-PAR)

Displays the status of the digital inputs in binary/hexadecimal code. This display can be used to check the input signals.

or
0000 ... 01FF
(hex) (Display with *SK-TU3-CTR *SK -CSX-0)

- Bit 0** = Digital input 1
- Bit 1** = Digital input 2
- Bit 2** = Digital input 3
- Bit 3** = Digital input 4
- Bit 4** = Digital input 5
- Bit 5** = Digital input 6 (SK 520E and above)
- Bit 6** = Digital input 7 (SK 520E and above)
- Bit 7** = Analog input 1 (digital function)
- Bit 8** = Analog input 2 (digital function)
- Bit 9** = Digital input 8 (SK 540E and above)
- Bit 10** = Digital input 1/1 IOE (SK 540E and above)
- Bit 11** = Digital input 2/1 IOE (SK 540E and above)
- Bit 12** = Digital input 3/1 IOE (SK 540E and above)
- Bit 13** = Digital input 4/1 IOE (SK 540E and above)
- Bit 14** = Digital input 1/2 IOE (SK 540E and above)
- Bit 15** = Digital input 2/2 IOE (SK 540E and above)

	Bits 11-8	Bits 7-4	Bits 3-0	
Minimum value	0000	0000	0000	Binary
	0	0	0	hex
Maximum value	0001	1111	1111	Binary
	1	F	F	hex

ControlBox: the binary Bits are converted into a hexadecimal value and displayed.

ParameterBox: the Bits are displayed increasing from right to left (binary).

P709	Voltage analog input 1 <i>(Voltage analog input 1)</i>		
-------------	--	--	--

-10.00 ... 10.00 V Displays the measured analog input value 1.

P710	Analog output voltage <i>(Analog output voltage)</i>		
-------------	--	--	--

0.0 ... 10.0 V Displays the value which is output from analog output 1.

P711	State of relays <i>(State of digital outputs)</i>		
-------------	---	--	--

000000000 ...
111111111 (binary)
(Display with *SK-TU3-PAR)

Displays the actual status of the signal relays.

or
0000 ... 01FF (hex)
(Display with *SK-TU3-CTR *SK-CSX-0)

- Bit 0** = Relay 1
- Bit 1** = Relay 2
- Bit 2** = Digital output 1
- Bit 3** = Digital output 2
- Bit 4** = Dig. Fct. Aout 1 (digital function Analog output 1)
- Bit 5** = Digital output 3 (SK 540E and above)
- Bit 6** = Digital output 1/1 IOE (SK 540E and above)
- Bit 7** = Digital output 2/1 IOE (SK 540E and above)
- Bit 8** = Digital output 1/2 IOE (SK 540E and above)
- Bit 9** = Digital output 2/2 IOE (SK 540E and above)

P712	Voltage analog input 2 <i>(Voltage analog input 2)</i>		
-------------	--	--	--

-10.00 ... 10.00 V Displays the measured analog input value 2.

P714	Operating time (Operating time)			
0.10 ... ____ h	This parameter shows the time for which the FI was connected to the mains and was ready for operation.			
P715	Running time (Enablement time)			
0.00 ... ____ h	This parameter shows the time for which the FI was enabled and supplied current to the output.			
P716	Current frequency (Actual frequency)			
-400.0 ... 400.0 Hz	Displays the actual output frequency.			
P717	Current speed (Actual rotation speed)			
-9999 ... 9999 rpm	Displays the actual motor speed calculated by the FI.			
P718	Present Actual setpoint frequency (Actual setpoint frequency)			
-400.0 ... 400.0 Hz	Displays the frequency specified by the setpoint (please see chapter 8.1 "Setpoint processing"). [-01] = Actual setpoint frequency from the setpoint source [-02] = Actual setpoint frequency after processing in the FI status machine [-03] = Actual setpoint frequency after frequency ramp			
P719	Actual current (Actual current)			
0.0 ... 999.9 A	Displays the actual output current.			
P720	Act. torque current (Actual torque current)			
-999.9 ... 999.9 A	Displays the actual calculated torque-developing output current (active current). Basis for calculation are the motor data P201...P209. → negative values = generator, → positive values = drive			
P721	Actual field current (Actual field current)			
-999.9 ... 999.9 A	Displays the actual calculated field current (reactive current). Basis for calculation are the motor data P201...P209.			
P722	Current voltage (Actual voltage)			
0 ... 500 V	Displays the actual AC voltage supplied by the FI output.			
P723	Voltage -d (Actual voltage component U_d)		S	
-500 ... 500 V	Displays the actual field voltage component.			
P724	Voltage -q (Actual voltage component U_q)		S	
-500 ... 500 V	Displays the actual torque voltage component.			

P725	Current Cos phi (Actual $\cos\phi$)			
0.00 ... 1.00	Displays the actual calculated $\cos\phi$ of the drive.			
P726	Apparent power (Apparent power)			
0.00 ... 300.00 kVA	Displays the actual calculated apparent power. The basis for calculation are the motor data P201...P209.			
P727	Mechanical power (Mechanical power)			
-99.99 ... 99.99 kW	Displays the actual calculated effective power of the motor. Basis for calculation are the motor data P201...P209.			
P728	Input voltage (mains voltage)			
0 ... 1000 V	Displays the actual mains voltage at the FI input. This is directly determined from the amount of the intermediate circuit voltage			
P729	Torque (Torque)			
-400 ... 400 %	Displays the actual calculated torque. Basis for calculation are the motor data P201...P209.			
P730	Field (Field)			
0 ... 100 %	Displays the actual field in the motor calculated by the FI. The basis for calculation are the motor data P201...P209.			
P731	Parameter set (Actual parameter set)			
0 ... 3	Shows the actual operating parameter set. 0 = Parameter set 1 1 = Parameter set 2 2 = Parameter set 3 3 = Parameter set 4			
P732	Phase U current (U phase current)		S	
0.0 ... 999.9 A	Displays the actual U phase current. NOTE: This value can deviate somewhat from the value in P719, due to the measurement procedure used, even with symmetrical output currents.			
P733	Phase V current (V phase current)		S	
0.0 ... 999.9 A	Displays the actual V phase current. NOTE: This value can deviate somewhat from the value in P719, due to the measurement procedure used, even with symmetrical output currents.			

P734	Phase W current (<i>W phase current</i>)		S	
0.0 ... 999.9 A	Displays the actual W phase current. NOTE: This value can deviate somewhat from the value in P719, due to the measurement procedure used, even with symmetrical output currents.			
P735	Speed encoder (<i>Speed encoder</i>)	SK 520E or higher	S	
-9999 ... 9999 rpm	Displays the actual rotation speed supplied by the incremental encoder. For this, P301 must be correctly set.			
P736	D.c. link voltage (<i>DC link voltage</i>)			
0 ... 1000 V DC	Displays the actual link voltage.			
P737	Usage rate brakeres. (<i>Actual brake resistor usage rate</i>)			
0 ... 1000 %	This parameter provides information about the actual degree of modulation of the brake chopper or the current utilisation of the braking resistor in generator mode. If parameters P556 and P557 are correctly set, the utilisation related to P557, the resistor power, is displayed. If only P556 is correctly set (P557=0), the degree of modulation of the brake chopper is displayed. Here, 100 means that the brake resistor is fully switched. On the other hand, 0 means that the brake chopper is not active at present. If P556 = 0 and P557 = 0, this parameter also provides information about the degree of modulation of the brake chopper in the FI.			
P738	Usage rate motor (<i>Actual utilisation of motor</i>)			
0 ... 1000 %	Shows the actual motor load. Basis for calculation is the motor data P203. The actually recorded current is related to the nominal motor current.			
P739	Heat sink temp. (<i>Actual temperature of heat sink</i>)			
0 ... 150 °C.	Displays the actual temperature of the FI heat sink. This value is used for overtemperature switch-off (E001).			

P740	[-01] PZD bus In ... [-19] <i>(Process data Bus In)</i>		S	
0000 ... FFFF (hex)	This parameter provides information about the actual control word and the setpoints that are transferred via the bus systems. For display, a BUS system must be selected in P509. Standardisation: (📖 section 8.7 "Standardisation of setpoint / target values")	[-01] = Control word [-02] = Setpoint 1 (P510/1, P546) [-03] = Setpoint 2 (P510/1, ...) [-04] = Setpoint 3 (P510/1, ...) [-05] = res.status InBit P480 [-06] = Parameter data In 1 [-07] = Parameter data In 2 [-08] = Parameter data In 3 [-09] = Parameter data In 4 [-10] = Parameter data In 5 [-11] = Setpoint 1 (P510/2) [-12] = Setpoint 2 (P510/2) [-13] = Setpoint 3 (P510/2) [-14] = Control word PLC [-15] = Setpoint 1 PLC ... [-19] = Setpoint 5 PLC		Control word, source from P509. Setpoint data from main setpoint (P510 [-01]). The displayed value depicts all Bus In Bit sources linked with an "OR". Data during parameter transfer: Order label (AK), Parameter number (PNU), Index (IND), Parameter value (PWE 1/2) Setpoint data from the master function value (Broadcast) - (P502/P503), if P509 = 9/10 Control word + Setpoint data from PLC
P741	[-01] PZD bus Out ... [-19] <i>(Process data Bus Out)</i>		S	
0000 ... FFFF (hex)	This parameter provides information about the actual status word and the actual values that are transferred via the bus systems. Standardisation: (📖 section 8.7 "Standardisation of setpoint / target values")	[-01] = Status word [-02] = Actual value 1 (P543) [-03] = Actual value 2 (...) [-04] = Actual value 3 (...) [-05] = res.status OutBit P481 [-06] = Parameter data Out 1 [-07] = Parameter data Out 2 [-08] = Parameter data Out 3 [-09] = Parameter data Out 4 [-10] = Parameter data Out 5 [-11] = Actual value 1 master funct. [-12] = Actual value 2 master funct. [-13] = Actual value 3 master funct. [-14] = Status word PLC [-15] = Actual value 1 PLC ... [-19] = Actual value 5 PLC		Status word, source from P509. Actual values The displayed value depicts all Bus OUT Bit sources linked with an "OR". Data during parameter transfer. Actual value of master function P502 / P503. Status word + Actual values to PLC
P742	Data base version <i>(Database version)</i>		S	
0 ... 9999	Displays the internal database version of the FI.			
P743	Inverter type <i>(Inverter type)</i>			
0.00 ... 250.00	Displays the inverter power in kW, e.g. "1.50" ⇒ FI with 1.5 kW nominal power.			

P744	Configuration <i>(Configuration level)</i>															
0000 ... FFFF (hex)	This parameter displays the special devices integrated in the FI. Display is in hexadecimal code (SimpleBox, ControlBox, Bus system). The display is in plain text when the ParameterBox is used.															
	SK 500E ... 515E = 0000	SK 530E ... 535E = 0201														
	SK 520E = 0101	SK 540E ... 545E = 0301														
P745	Module version <i>(Module version)</i>															
-3276.8 ... 3276.8	Version status (software version) of the technology unit (SK TU3-xxx), but only when own processor is present, i.e. not for SK TU3-CTR. Have this data available if you have a technical query.															
P746	Module status <i>(Module status)</i>		S													
0000 ... FFFF (hex)	Shows the actual status (readiness, error, communication) of the technology unit (SK TU3-xxx), but only when own processor is present, i.e. not for SK TU3-CTR. Code details can be found in the respective BUS module manual. Different contents are shown depending on the modules.															
P747	Inverter Volt. Range <i>(Inverter voltage range)</i>															
0 ... 3	Indicates the mains voltage range for which this device is specified. 0 = 100...120V 1 = 200...240V 2 = 380...480V 3 = 400...500V															
P748	Status CANopen <i>(CANopen status)</i>	SK 520E or higher	S													
0000 ... FFFF (hex)	[01] = CANbus/CANopen status Bit 0 = 24V bus voltage supply Bit 1 = CANbus in "Bus Warning" status Bit 2 = CANbus in "Bus Off" status Bit 3 = System bus → Bus module online (field bus module, e.g.: SK xU4-PBR) Bit 4 = System bus → Additional module 1 online (I/O - module, e.g.: SK xU4-IOE) Bit 5 = System bus → Additional module 2 online (I/O - module, e.g.: SK xU4-IOE) Bit 6 = Protocol of the CAN module is 0 = CAN or 1 = CANopen Bit 7 = free Bit 8 = "Bootsup Message" sent Bit 9 = CANopen NMT State Bit 10 = CANopen NMT State Bit 11 ... 15 = free	[-02] = reserved	[-03] = reserved													
	<table border="1"> <thead> <tr> <th>CANopen NMT State</th> <th>Bit 10</th> <th>Bit 9</th> </tr> </thead> <tbody> <tr> <td>Stopped =</td> <td>0</td> <td>0</td> </tr> <tr> <td>Pre-Operational =</td> <td>0</td> <td>1</td> </tr> <tr> <td>Operational =</td> <td>1</td> <td>0</td> </tr> </tbody> </table>	CANopen NMT State	Bit 10	Bit 9	Stopped =	0	0	Pre-Operational =	0	1	Operational =	1	0			
CANopen NMT State	Bit 10	Bit 9														
Stopped =	0	0														
Pre-Operational =	0	1														
Operational =	1	0														

P750	Stat. overcurrent (<i>Overcurrent statistics</i>)		S	
0 ... 9999	Number of overcurrent messages during the operating period P714.			
P751	Stat. Overvoltage (<i>Overvoltage statistics</i>)		S	
0 ... 9999	Number of overvoltage messages during the operating period P714.			
P752	Stat. mains failure (<i>Mains failure statistics</i>)		S	
0 ... 9999	Number of mains faults during the operating period P714.			
P753	Stat. overtemperature (<i>Overheating statistics</i>)		S	
0 ... 9999	Number of overtemperature faults during the operating period P714.			
P754	Stat. parameter lost (<i>Parameter loss statistics</i>)		S	
0 ... 9999	Number of parameters lost during the operating period P714.			
P755	Stat. system error (<i>System fault statistics</i>)		S	
0 ... 9999	Number of system faults during the operating period P714.			
P756	Stat. Timeout (<i>Time out statistics</i>)		S	
0 ... 9999	Number of Time out errors during the operating period P714.			
P757	Stat. Customer error (<i>Customer fault statistics</i>)		S	
0 ... 9999	Number of Customer Watchdog faults during the operating period P714.			
P799	Op.-time last error (<i>Operating time, last fault 1...5</i>)			
0.1 ... ____ h	This parameter shows the operating hours counter status (P714) at the moment of the previous fault. Array 01...05 corresponds to the lastest fault 1...5.			

6 Operating status messages

The device and technology units generate appropriate messages if they deviate from their normal operating status. There is a differentiation between warning and error messages. If the device is in the status "Start disabled", the reason for this can also be displayed.

The messages generated for the device are displayed in the corresponding array of parameter (**P700**). The display of the messages for technology units is described in the respective additional instructions and data sheets for the modules concerned.

Start disabled

If the device is in the status "Not Ready" or "Start Disabled", the reason for this is indicated in the third array element of parameter (**P700**).

Display is only possible with the NORD CON software or the ParameterBox.

Warning messages

Warning messages are generated as soon as a defined limit is reached. However this does not cause the frequency inverter to switch off. These messages can be displayed via the array-element [-02] in parameter (**P700**) until either the reason for the warning is no longer present or the frequency inverter has gone into a fault state with an error message.

Error messages

Errors cause the device to switch off, in order to prevent a device fault.

The following options are available to reset a fault (acknowledge):

- Switching the mains off and on again,
- By an appropriately programmed digital input (**P420**),
- By switching off the "enable" on the device (if no digital input is programmed for acknowledgement),
- By Bus acknowledgement
- By (**P506**), automatic error acknowledgement.

6.1 Display of messages

LED displays

The status of the FI is indicated by integrated status LEDs, which are visible from the outside in the state as delivered. According to the type of FI, this is a two-colour LED (DS = DeviceState) or two single-colour LEDs (DS DeviceState and DE = DeviceError).

Meaning:	Green indicates readiness and the present of mains voltage. In operation, the level of overload at the FI output is shown with an increasingly rapid flashing code. Red Signals the presence of an error by flashing according to the number code of the error. This flashing code (e.g.: E003 = 3x flashing) indicates the error groups.
-----------------	--

SimpleBox / ControlBox - display

The SimpleBox / ControlBox displays an error with its number and the prefix "E". In addition, the current fault can be displayed in array element [-01] of parameter (P700). The last error messages are stored in parameter P701. Further information on inverter status at the time that the error occurs can be found in parameters P702 to P706 / P799.

If the cause of the error is no longer present, the error display in the SimpleBox / ControlBox flashes and the error can be acknowledged with the Enter key.

In contrast, warning messages are prefixed with "C" ("Cxxx") and cannot be acknowledged. They disappear automatically when the reason for them is no longer present or the frequency inverter has switched to the "Error" state. Display of the message is suppressed if the warning appears during parameterisation.

The present warning message can be displayed in detail at any time in array element [-02] of parameter (P700).

The reason for an existing disabled switch on cannot be displayed with the SimpleBox / ControlBox.

ParameterBox display

The ParameterBox displays the messages in plain text.

6.2 Messages

Error messages

Display in the SimpleBox / ControlBox		Fault Text in the ParameterBox	Cause • Remedy
Group	Details in P700 [-01] / P701		
E001	1.0	Overtemp. Inverter <i>"Inverter overtemperature"</i> (inverter heat sink)	Inverter temperature monitoring measurements are outside of the permissible temperature range, i.e. the error is triggered if the permissible lower limit is undershot or the permissible upper temperature limit is exceeded. <ul style="list-style-type: none"> Depending on the cause: Reduce or increase the ambient temperature Check the FI fan / control cabinet ventilation Check the FI for dirt
	1.1	Overtemp. FI internal <i>"Internal FI overtemperature"</i> (interior of FI)	
E002	2.0	Overtemp. Motor PTC <i>"Overtemperature motor thermistor "</i>	Motor temperature sensor (PTC) has triggered <ul style="list-style-type: none"> Reduce motor load Increase motor speed Use external motor fan
	2.1	Overtemp. Motor I²t <i>"Motor overtemperature I²t"</i> <u>Only</u> if I ² t motor (P535) is programmed.	I ² t motor has triggered (calculated overtemperature of motor) <ul style="list-style-type: none"> Reduce motor load Increase motor speed
	2.2	Overtemp. Brake r.ext <i>"Overtemperature of external brake resistor "</i> Overtemperature via digital input (P420 [...])={13}	Temperature monitor (e.g. brake resistor) has activated <ul style="list-style-type: none"> Digital input is Low Check connection, temperature sensor

E003	3.0	I²t overcurrent limit	a.c. inverter: I ² t limit has triggered, e.g. > 1.5 x I _n for 60s (also note P504) <ul style="list-style-type: none"> • Continuous overload at inverter output • Possible encoder fault (resolution, defect, connection)
	3.1	Chopper overtemperature I²t	Brake chopper: I ² t limit has activated, 1.5 times values reached for 60s (please also pay attention to P554, if present, and P555, P556, P557) <ul style="list-style-type: none"> • Avoid overcurrent in brake resistance
	3.2	IGBT overcurrent 125% monitoring	De-rating (power reduction) <ul style="list-style-type: none"> • 125% overcurrent for 50ms • Brake chopper current too high • for fan drives: enable flying start circuit (P520)
	3.3	IGBT overcurrent fast 150% monitoring	De-rating (power reduction) <ul style="list-style-type: none"> • 150% overcurrent • Brake chopper current too high
E004	4.0	Overcurrent module	Error signal from module (short duration) <ul style="list-style-type: none"> • Short-circuit or earthing fault at FI output • Motor cable is too long • Use external output choke • Brake resistor faulty or resistance too low <p>→ Do not shut off P537! The occurrence of a fault can significantly shorten the service life of the device, or even destroy it.</p>
	4.1	Overcurrent measurement <i>"Overcurrent measurement"</i>	P537 (pulse current switch-off) was reached 3x within 50 ms (only possible if P112 and P536 are disabled) <ul style="list-style-type: none"> • FI is overloaded • Drive sluggish, insufficiently sized • Ramps (P102/P103) too steep -> Increase ramp time • Check motor data (P201 ... P209)
E005	5.0	Overvoltage UZW	Link circuit voltage too high <ul style="list-style-type: none"> • Increase deceleration time (P103) • If necessary, set switch-off mode (P108) with delay (not with lifting equipment) • Extend emergency stop time (P426) • Fluctuating speed (e.g. due to high centrifugal masses) → adjust U/f characteristic curve if necessary (P211, P212) <p>Devices with brake chopper:</p> <ul style="list-style-type: none"> • Reduce energy return using a braking resistor • Check the function of the connected braking resistor (broken cable) • Resistance value of connected braking resistor too high
	5.1	Mains overvoltage	Mains voltage is too high <ul style="list-style-type: none"> • See technical data (📖 Section 7)
E006	6.0	Charging error	Link circuit voltage is too low <ul style="list-style-type: none"> • Mains voltage too low • See technical data (📖 Section 7)
	6.1	Mains undervoltage	Mains voltage too low <ul style="list-style-type: none"> • See technical data (📖 Section 7)

E007	7.0	Mains phase error	Error at terminal connection side <ul style="list-style-type: none"> • a network phase is not connected • network is non-symmetrical
E008	8.0	Parameter loss (maximum EEPROM value exceeded)	Error in EEPROM data <ul style="list-style-type: none"> • Software version of the stored data set not compatible with the software version of the FI. NOTE: <u>Faulty parameters</u> are automatically reloaded (default data). <ul style="list-style-type: none"> • EMC interferences (see also E020)
	8.1	Inverter type incorrect	<ul style="list-style-type: none"> • EEPROM faulty
	8.2	External copying error (ControlBox)	<ul style="list-style-type: none"> • Check ControlBox for correct position. • ControlBox EEPROM faulty (P550 = 1).
	8.3	EEPROM KSE error (Customer interface incorrectly identified (customer's interface equipment))	The upgrade level of the frequency inverter was not correctly identified. <ul style="list-style-type: none"> • Switch mains voltage off and on again.
	8.4	Internal EEPROM error (Database version incorrect)	
	8.5	No EEPROM recognised	
	8.6	EEPROM copy used	
	8.7	EEPROM copy not the same	
	8.8.	EEPROM is empty	
	8.9	EEPROM Ctrlbox too small	<ul style="list-style-type: none"> • The EEPROM of the ControlBox is too small to completely save the data set for the frequency inverter
E009	---	<i>Display in ParameterBox not required</i>	<i>ControlBox error/ SimpleBox error</i> SPI Bus faulty, no communication with ControlBox / SimpleBox <ul style="list-style-type: none"> • Check ControlBox for correct position. • Check correct cabling of SimpleBox. • Switch mains voltage off and on again.
E010	10.0	Bus Timeout	Telegram time-out / Bus off 24V int. CANbus) Data transfer is faulty. Check P513. <ul style="list-style-type: none"> • Check external Bus connection. • Check the program sequence of the Bus protocol • Check Bus Master. • Check 24V supply of internal CAN/CANopen Bus. • <i>Nodeguarding</i> error (internal CANopen) • <i>Bus Off</i> error (internal CANbus)
	10.2	Bus Timeout Option	Bus module telegram timeout <ul style="list-style-type: none"> • Telegram transfer is faulty. • Check external connection. • Check bus protocol program sequence. • Check Bus Master.
	10.4	Init error Option	Bus module initialisation failure <ul style="list-style-type: none"> • Check Bus module power supply. • Check P746. • Bus module not correctly plugged in.
	10.1	System error option	Bus module system error

	10.3		<ul style="list-style-type: none"> Further details can be found in the respective supplementary Bus operating instructions.
	10.5		
	10.6		
	10.7		
	10.8	Option error	
E011	11.0	Customer interface	<p>External module communication failure</p> <ul style="list-style-type: none"> Connection fault / error in the external module Brief interruption (<1sec) of the 24 V supply of the internal CAN/CANopen bus
E012	12.0	External watchdog	<p>The Watchdog function is selected at a digital input and the impulse at the corresponding digital input is not present for longer than the time set in parameter P460 >Watchdog time<.</p> <ul style="list-style-type: none"> Check connections Check P460 setting
	12.1	Motor limit <i>"Motor switch-off limit"</i>	<p>The motor switch-off limit P534 [-01] has triggered.</p> <ul style="list-style-type: none"> Reduce load on motor Set higher value in (P534 [-01]).
	12.2	Generator limit <i>"Generator switch-off limit"</i>	<p>The generator switch-off limit P534 [-02] has triggered.</p> <ul style="list-style-type: none"> Reduce load on motor Set higher value in (P534 [-02]).
	12.5	Load limit	<p>Switch-off due to overshooting or undershooting of permissible load torques ((P525) ... (P529)) for the time set in (P528).</p> <ul style="list-style-type: none"> Adjust load. Change limit values ((P525) ... (P527)). Increase delay time (P528). Change monitoring mode (P529).
	12.8	Analog In minimum	<p>Switch-off due to undershooting of the 0% adjustment value (P402) with setting (P401) "0-10V with switch-off on error 1" or "...2"</p>
	12.9	Analog In maximum	<p>Switch-off due to overshooting of the 100% adjustment value (P402) with setting (P401) "0-10V with switch-off on error 1" or "...2"</p>
E013	13.0	Encoder error	<p>No signal from encoder</p> <ul style="list-style-type: none"> Check 5V sensor if present. Check supply voltage of encoder.
	13.1	Speed slip error <i>"Speed slip error"</i>	<p>The slip speed error limit was reached.</p> <ul style="list-style-type: none"> Increase setting in P327.

	13.2	Shut-down monitoring	<p>The slip error monitoring has triggered; the motor could not follow the setpoint.</p> <ul style="list-style-type: none"> • Check motor data P201-P209! (Important for the current controller) • Check motor circuit. • In servo mode, check the encoder setting P300 and check the following • Increase setting value for torque limit in P112. • Increase setting value for current limit in P536. • Check deceleration time P103 and extend if necessary
	13.5	Reserved	Error message for POSICON → see supplementary instructions
	13.6	Reserved	Error message for POSICON → see supplementary instructions
E014	---	Reserved	Error message for POSICON → see supplementary instructions
E015	---	Reserved	
E016	16.0	Motor phase error	<p>A motor phase is not connected.</p> <ul style="list-style-type: none"> • Check P539 • Check motor connection
	16.1	Magnetisation current monitoring <i>"Magnetisation current monitoring"</i>	<p>Required exciting current not achieved at moment of switch-on.</p> <ul style="list-style-type: none"> • Check P539 • Check motor connection
E017	17.0	Customer interface fault	<ul style="list-style-type: none"> • EMC fault • Defective component
E018	18.0	Reserved	Error message for "Safe Pulse Block" → see supplementary instructions
E019	19.0	Parameter identification <i>"Parameter identification"</i>	<p>Automatic identification of the connected motor was unsuccessful</p> <ul style="list-style-type: none"> • Check motor connection • Check preset motor data (P201 ... P209) • PMSM – CFC Closed Loop Operation: Rotor position of motor incorrect in relation to incremental encoder Perform determination of rotor position (initial enable after a "Mains on" only with motor stationary (P330)
	19.1	Star / Delta circuit incorrect <i>"Motor star / delta circuit incorrect"</i>	

E020	20.0	Reserved	<p>System error in program execution, triggered by EMC interference.</p> <ul style="list-style-type: none"> • Observe wiring guidelines • Use additional external mains filter. • FI must be very well earthed.
E021	20.1	Watchdog	
	20.2	Stack overflow	
	20.3	Stack underflow	
	20.4	Undefined opcode	
	20.5	Protected Instruct. <i>"Protected Instruction"</i>	
	20.6	Illegal word access	
	20.7	Illegal Inst. Access <i>"Illegal instruction access"</i>	
	20.8	Program memory error <i>"Program memory error"</i> (EEPROM error)	
	20.9	Dual-ported RAM	
	21.0	NMI error (Not used by hardware)	
	21.1	PLL error	
	21.2	ADU error "Overrun"	
	21.3	PMI error "Access Error"	
	21.4	Userstack overflow	
E022	---	Reserved	Error message for PLC → see supplementary instructions BU 0550
E023	---	Reserved	Error message for PLC → see supplementary instructions BU 0550
E024	---	Reserved	Error message for PLC → see supplementary instructions BU 0550

Warning messages

Display in the SimpleBox / ControlBox		Warning Text in the ParameterBox	Cause • Remedy
Group	Details in P700 [-02]		
C001	1.0	Overtemp. Inverter <i>"Inverter overtemperature"</i> (inverter heat sink)	<p>Inverter temperature monitoring</p> <p>Warning: permissible temperature limit reached.</p> <ul style="list-style-type: none"> • Reduce ambient temperature • Check the FI fan / control cabinet ventilation • Check the FI for dirt
C002	2.0	Overtemp. Motor PTC <i>"Overtemperature motor thermistor "</i>	<p>Warning from motor temperature sensor (triggering threshold reached)</p> <ul style="list-style-type: none"> • Reduce motor load • Increase motor speed • Use external motor fan
	2.1	Overtemp. Motor I²t <i>"Motor overtemperature I²t"</i> <u>Only</u> if I ² t motor (P535) is programmed.	<p>Warning: I²t- motor monitoring (1.3 times the rated current reached for the time period specified in (P535))</p> <ul style="list-style-type: none"> • Reduce motor load • Increase motor speed

	2.2	Overtemp. Brake r.ext "Overtemperature of external brake resistor " Overtemperature via digital input (P420 [...])={13}	Warning: Temperature monitor (e.g. brake resistor) has activated <ul style="list-style-type: none"> Digital input is Low
C003	3.0	Overcurrent, I²t limit	Warning: Inverter: I ² t limit has triggered, e.g. > 1.3 x I _n for 60s (please also note P504) <ul style="list-style-type: none"> Continuous overload at FI output
	3.1	Overcurrent, chopper I²t	Warning: I ² t limit for the brake chopper has triggered, 1.3x value attained for 60s (also note P554, if present, as well as P555, P556, P557) <ul style="list-style-type: none"> Avoid overload of brake resistance
	3.5	Torque current limit	Warning: Torque current limit reached <ul style="list-style-type: none"> Check (P112)
	3.6	Current limit	Warning: Current limit reached <ul style="list-style-type: none"> Check (P536)
C004	4.1	Overcurrent measurement "Overcurrent measurement"	Warning: pulse switch off is active The limit for activation of pulse switch off (P537) has been reached (only possible if P112 and P536 are switched off) <ul style="list-style-type: none"> FI is overloaded Drive sluggish, insufficiently sized Ramps (P102/P103) too steep -> Increase ramp time Check motor data (P201 ... P209) Switch off slip compensation (P212)
C008	8.0	Parameter loss	Warning: One of the cyclically saved messages such as <i>operating hours</i> or <i>enabling time</i> could not be saved successfully. The warning disappears as soon as saving can be successfully performed.
C012	12.1	Motor Limit / Customer "Motor switch-off limit"	Warning: 80 % of the drive switch-off limit (P534 [-01]) has been exceeded. <ul style="list-style-type: none"> Reduce load on motor Set higher value in (P534 [-01]).
	12.2	Generator limit "Generator switch-off limit"	Warning: 80 % of the generator switch-off limit (P534 [-02]) has been reached. <ul style="list-style-type: none"> Reduce load on motor Set higher value in (P534 [-02]).
	12.5	Load monitor	Warning due to overshooting or undershooting of permissible load torques ((P525) ... (P529)) for the time set in (P528). <ul style="list-style-type: none"> Adjust load. Change limit values ((P525) ... (P527)). Increase delay time (P528).

Switch-on block messages

Display in the SimpleBox / ControlBox		Reason: Text in the ParameterBox	Cause • Remedy
Group	Details in P700 [-03]		
I000	0.1	Disable voltage from IO	If the function "disable voltage" is parameterised, input (P420 / P480) is at Low <ul style="list-style-type: none"> • Set "input High" • Check signal cable (broken cable)
	0.2	IO fast stop	If the function "fast stop" is parameterised, input (P420 / P480) is at Low <ul style="list-style-type: none"> • Set "input High" • Check signal cable (broken cable)
	0.3	Block voltage from bus	<ul style="list-style-type: none"> • For bus operation (P509): control word Bit 1 is "Low"
	0.4	Bus fast stop	<ul style="list-style-type: none"> • For bus operation (P509): control word Bit 2 is "Low"
	0.5	Enable on start	Enable signal (control word, Dig I/O or Bus I/O) was already applied during the initialisation phase (after mains "ON", or control voltage "ON"). Or electrical phase is missing. <ul style="list-style-type: none"> • Only issue enable signal after completion of initialisation (i.e. when the FI is ready) • Activation of "Automatic Start" (P428)
	0.6 – 0.7	Reserved	Information message for PLC → see supplementary instructions
	0.8	Right direction blocked	Switch-on block with inverter shut-off activated by: P540 or by "Enable right block" (P420 = 31, 73) or "Enable left block" (P420 = 32, 74), The frequency inverter switches to "Ready for switching on" status
	0.9	Left direction blocked	
	I006	6.0	Charging error
I011	11.0	Analog Stop	If an analog input of the frequency inverter or a connected IO extension is configured to detect cable breaks (2-10V signal or 4-20mA signal), the frequency inverter switches to the status "ready for switch-on" if the analog signal undershoots the value 1 V or 2 mA This also occurs if the relevant analog input is parameterised to function "0" ("no function"). <ul style="list-style-type: none"> • Check connections
I014	14.4	Reserved	Error message for POSICON → see supplementary instructions
I018	18.0	Reserved	Information message for "Safe Stop" function → see supplementary instructions

7 Technical data

7.1 General Data SK 500E

Function	Specification
Output frequency	0.0 ... 400.0 Hz
Pulse frequency	3.0 ... 16.0 kHz, standard setting = 6 kHz (Size 8 and above = 4 kHz) Power reduction > 8 kHz for 230 V inverter, > 6 kHz for 400 V - inverter
Typical overload capacity	150 % for 60 s 200 % for 3.5 s
Efficiency of frequency inverter	Size 1 – 4: approx. 95 %, Size 5 – 7: approx. 97 %, Size 8 and above: approx. 98 %
Insulation resistance	> 5 MΩ
Ambient temperature	0°C ... +40°C (S1-100 % ED), 0°C ... +50°C (S3-70 % ED 10 min)
Storage and transport temperature	-20°C ... +60 /70°C
Long-term storage	(chapter 9.1)
Protection class	IP20
Max. installation altitude above sea level	- up to 1000 m without power reduction - 1000...4000 m: 1 %/ 100 m power reduction * Up to 2000 m: Overvoltage category 3 * up to 4,000m: Overvoltage category 2, mains input: Overvoltage protection required
Ambient conditions	Transport (IEC 60721-3-2): Vibration: 2M1 Operation (IEC 60721-3-3): Vibration: 3M4; Climate: 3K3;
Waiting period between 2 x "Mains on"	60 s for all devices in normal operating cycle
Protective measures against	Overtemperature of the frequency inverter, overvoltage and undervoltage Short-circuit, earthing fault, overload
Regulation and control	Sensorless current vector control (ISD), linear V/f characteristic VFC open-loop, CFC open-loop, CFC closed-loop (above SK 520E)
Motor temperature monitoring	I ² t-Motor (UL approved), PTC / Bi-metal switch
Interfaces (integrated)	RS 485 (USS) CANbus (except SK 50xE) RS 232 (single slave) CANopen (except SK 50xE) Modbus RTU
Electrical isolation	Control terminals (digital and analog inputs)
Connection terminals	For details and tightening torques of the screw terminals: refer to (chapter 2.9.4) and (chapter 2.9.5).
External supply voltage, control unit SK 5x5E	Size 1 - 4: 18...30 V DC, ≥ 800 mA Size 5 - 7: 24...30 V DC, ≥ 1000 mA Size 8 - 11: 24...30 V DC, ≥ 3000 mA
Analogue setpoint input / PID input	2x (above Size 5: - 10 V...) 0...10V, 0/4...20 mA, scalable, digital 7.5...30 V
Analogue setpoint resolution	10 bit based on measurement range
Setpoint consistency	analog < 1 %, digital < 0.02 %
Digital input	5x (2,5 V) 7,5...30 V, R _i = (2,2 kΩ) 6,1 kΩ, cycle time = 1...2 ms + for SK 520E and above: 2x 7.5...30 V, R _i = 6.1 kΩ, cycle time = 1...2 ms

Control outputs	<p>2x Relay 28 VDC / 230 VAC, 2 A (output 1/2 - K1/K2)</p> <p>Additionally, with SK 520E/530E: 2x DOUT 15 V, 20 mA or</p> <p>Additionally, with SK 535E/545E: 2x DOUT 18...30 V (depending on VI), 20 mA, or 2x DOUT 18...30 V, 200 mA Size 5 and above</p> <p>(Output 3/4 - DOUT1/2)</p>
Analogue output	0 ... 10 V scalable

7.2 Technical data for determining the energy efficiency level

The following tables relate to the provisions of the Ecodesign EU Regulation 2019/1781.

Manufacturer	FI type	Rel. losses (rel. motor stator frequency / rel. torque-producing current)								Standby	IE rating
		90/100	90/50	50/100	50/50	50/25	0/100	0/50	0/25		
Getriebebau NORD GmbH & Co. KG	SK 5xxE-	[%]	[%]	[%]	[%]	[%]	[%]	[%]	[%]	[W]	
	250-323	4,8	4,1	4,3	3,9	3,8	4,0	3,7	3,7	6,2	IE2
	370-323	4,1	3,3	3,6	3,2	3,1	3,3	3,0	3,0	6,2	IE2
	550-323	3,6	2,8	3,2	2,7	2,6	2,9	2,5	2,5	6,2	IE2
	750-323	3,4	2,6	2,9	2,4	2,3	2,6	2,2	2,2	6,2	IE2
	111-323	3,1	2,1	2,6	1,9	1,6	2,2	1,8	1,6	6,5	IE2
	151-323	3,1	2,1	2,6	1,9	1,6	2,2	1,7	1,5	6,5	IE2
	221-323	3,2	2,1	2,7	1,9	1,6	2,4	1,8	1,6	6,5	IE2
	301-323	3,0	2,0	2,5	1,8	1,5	2,2	1,6	1,4	6,9	IE2
	401-323	3,0	1,9	2,4	1,7	1,3	2,1	1,5	1,3	6,9	IE2
	551-323	4,2	3,0	3,7	2,8	2,4	3,3	2,6	2,3	50,0	IE2
	751-323	4,0	2,4	3,3	2,2	1,8	2,9	2,0	1,7	50,0	IE2
	112-323	4,0	2,3	3,4	2,2	1,7	3,1	2,0	1,7	50,0	IE2
	152-323	3,4	1,9	2,7	1,6	1,3	2,3	1,4	1,2	50,0	IE2
	182-323	3,5	1,9	2,9	1,7	1,3	2,4	1,5	1,2	50,0	IE2
	550-340	3,9	3,4	3,7	3,3	3,2	3,6	3,2	3,2	8,5	IE2
	750-340	3,4	2,7	3,2	2,6	2,4	3,1	2,5	2,3	8,5	IE2
	111-340	3,1	2,3	2,9	2,2	2,0	2,7	2,2	2,0	8,9	IE2
	151-340	3,0	2,2	2,8	2,1	1,8	2,6	2,0	1,8	8,9	IE2
	221-340	2,9	2,0	2,6	1,9	1,6	2,4	1,8	1,5	8,9	IE2
	301-340	2,9	2,0	2,6	1,9	1,6	2,4	1,8	1,5	10,6	IE2
	401-340	2,8	1,9	2,6	1,8	1,5	2,3	1,7	1,4	10,6	IE2
	551-340	2,5	1,4	2,2	1,3	1,0	2,0	1,2	1,0	11,8	IE2
	751-340	2,4	1,3	2,1	1,2	0,9	1,8	1,1	0,9	11,8	IE2
	112-340	2,7	1,6	2,4	1,5	1,2	2,2	1,5	1,2	24,9	IE2
	152-340	2,5	1,5	2,3	1,4	1,1	2,0	1,3	1,1	24,9	IE2
	182-340	2,7	1,6	2,4	1,5	1,2	2,2	1,4	1,1	24,6	IE2
	222-340	2,7	1,5	2,4	1,4	1,1	2,1	1,3	1,0	24,6	IE2
	302-340	2,3	1,3	2,0	1,2	0,9	1,9	1,1	0,9	30,7	IE2
	372-340	2,6	1,5	2,3	1,4	1,0	2,1	1,3	1,0	30,7	IE2
452-340	1,7	0,9	1,5	0,8	0,6	1,4	0,8	0,6	21,1	IE2	
552-340	1,8	0,9	1,6	0,8	0,6	1,4	0,7	0,5	21,1	IE2	
752-340	2,0	1,0	1,7	0,9	0,6	1,5	0,8	0,6	25,2	IE2	
902-340	2,1	1,0	1,7	0,9	0,6	1,5	0,8	0,6	25,2	IE2	
113-340	1,7	0,8	1,4	0,8	0,5	1,2	0,7	0,5	32,0	IE2	
133-340	1,9	0,9	1,6	0,9	0,6	1,4	0,8	0,6	32,0	IE2	
163-340	2,0	1,0	1,7	0,9	0,6	1,4	0,8	0,6	49,8	IE2	
203-340	2,1	1,0	1,7	0,9	0,6	1,4	0,7	0,5	60,5	IE2	

Manufacturer	FI type	Output power	Indicative output power	Rated output current	Max. operating temperature	Rated input frequency	Rated input voltage range
Getriebebau NORD GmbH & Co. KG	SK 5xxE-	[kVA]	[kW]	[A]	[°C]	[Hz]	[V]
	250-323	0,5	0,3	1,3	40	50	200 V - 240 V
	370-323	0,7	0,4	1,8	40	50	200 V - 240 V
	550-323	1,0	0,6	2,6	40	50	200 V - 240 V
	750-323	1,3	0,8	3,4	40	50	200 V - 240 V
	111-323	1,7	1,1	4,5	40	50	200 V - 240 V
	151-323	2,3	1,5	6,0	40	50	200 V - 240 V
	221-323	3,3	2,2	8,7	40	50	200 V - 240 V
	301-323	4,4	3,0	11,7	40	50	200 V - 240 V
	401-323	5,9	4,0	15,3	40	50	200 V - 240 V
	551-323	7,9	5,5	20,8	40	50	200 V - 240 V
	751-323	10,0	7,5	26,1	40	50	200 V - 240 V
	112-323	14,4	11,0	37,8	40	50	200 V - 240 V
	152-323	19,5	15,0	51,1	40	50	200 V - 240 V
	182-323	23,9	18,5	62,6	40	50	200 V - 240 V
	550-340	1,2	0,6	1,7	40	50	380 V – 480 V
	750-340	1,6	0,8	2,3	40	50	380 V – 480 V
	111-340	2,1	1,1	3,1	40	50	380 V – 480 V
	151-340	2,8	1,5	4,0	40	50	380 V – 480 V
	221-340	3,8	2,2	5,5	40	50	380 V – 480 V
	301-340	5,2	3,0	7,5	40	50	380 V – 480 V
	401-340	6,6	4,0	9,5	40	50	380 V – 480 V
	551-340	8,7	5,5	12,5	40	50	380 V – 480 V
	751-340	11,1	7,5	16,0	40	50	380 V – 480 V
	112-340	16,6	11,0	24,0	40	50	380 V – 480 V
	152-340	21,5	15,0	31,0	40	50	380 V – 480 V
	182-340	26,3	18,5	38,0	40	50	380 V – 480 V
	222-340	31,9	22,0	46,0	40	50	380 V – 480 V
	302-340	41,6	30,0	60,0	40	50	380 V – 480 V
	372-340	52,0	37,0	75,0	40	50	380 V – 480 V
	452-340	62,4	45,0	90,0	40	50	380 V – 480 V
	552-340	76,2	55,0	110,0	40	50	380 V – 480 V
752-340	103,9	75,0	150,0	40	50	380 V – 480 V	
902-340	124,7	90,0	180,0	40	50	380 V – 480 V	
113-340	135,4	110,0	205,6	40	50	380 V – 480 V	
133-340	162,1	132,0	246,3	40	50	380 V – 480 V	
163-340	196,0	160,0	297,9	40	50	380 V – 480 V	
203-340	244,5	200,0	371,5	40	50	380 V – 480 V	

7.3 Electrical data

The following tables contain the data which is relevant for UL.

Details of the UL/cUL approval conditions can be found in Section 1.7. Use of mains fuses which are faster than those stated is permissible.

By the use of a mains choke, the input current is reduced to approximately that of the output current (see Section 2.7.1 "Mains chokes").

7.3.1 Electrical data 115 V

Frequency inverter type		SK 5xxE...	-250-112-	-370-112-	-550-112-	-750-112-	-111-112-	
			1	1	1	1	1	
Nominal motor power (4-pole standard motor)	230 V		0.25 kW	0.37 kW	0.55 kW	0.75 kW	1.10 kW	
	240 V		1/3 hp	1/2 hp	3/4 hp	1 hp	1 1/2 hp	
Mains voltage	115 V	1 AC 100 ... 120 V, ± 10 %, 47 ... 63 Hz						
Input current	rms		8.9 A	11.0 A	13.1 A	20.1 A	23.5 A	
	FLA		8.9 A	10.8 A	13.1 A	20.1 A	23.5 A	
Output voltage	230 V	3 AC 0 – 2x mains voltage						
Typical output	rms		1.7 A	2.2 A	3.0 A	4.0 A	5.3 A	
	FLA		1.7 A	2.1 A	3.0 A	4.0 A	5.3 A	
Min. brake resistor	Accessories		240 Ω	190 Ω	140 Ω	100 Ω	75 Ω	
Pulse frequency	range	3 – 16 kHz						
	Factory setting	6 kHz						
Ambient temperature	S1		40 °C	40 °C.	40 °C.	40 °C.	40 °C.	
	S3 80 %, 10 min		50 °C.	50 °C.	50 °C.	50 °C.	50 °C.	
	S3 70 %, 10 min		50 °C.	50 °C.	50 °C.	50 °C.	50 °C.	
Type of ventilation		Free convection						
Weight	Approx. [kg]		1.4				1.8	
		General fuses (AC) (recommended)						
slow-blowing			10 A	16 A	16 A	25 A	25 A	
		UL fuses (AC) – permitted						
		Isc ¹⁾ [A]						
		5 000	10 000					
		Class	100 000					
Fuse	J (600 V)	x		10 A	13 A	20 A	25 A	25 A
	CC, J, R, T, G, L (300 V)		x	10 A	20 A	20 A	25 A	20 A
	Bussmann LPJ-	x		10SP	13SP	20SP	25SP	25SP
CB	(480 V)		x	15 A	15 A	20 A	25 A	20 A

1) Maximum permissible mains overload current

7.3.2 Electrical data 230 V

Note: Fields with 2 values (separated by a forward slash) should be read as follows:

- The first value applies for a single phase mains connection
- The second value applies for a three-phase mains connection

Frequency inverter type		SK 5xxE...	-250-323-	-370-323-	-550-323-	-750-323-		
		Size	1	1	1	1		
Nominal motor power (4-pole standard motor)	230 V		0.25 kW	0.37 kW	0.55 kW	0.75 kW		
	240 V		1/3 hp	1/2 hp	3/4 hp	1 hp		
Mains voltage	230 V	1 / 3 AC 200 ... 240 V, ± 10 %, 47 ... 63 Hz						
Input current	rms		3.7 / 2.4 A	4.8 / 3.1 A	6.5 / 4.2 A	8.7 / 5.6 A		
	FLA		3.7 / 2.4 A	4.8 / 3.1 A	6.5 / 4.2 A	8.7 / 5.6 A		
Output voltage	230 V	3 AC 0 - Mains voltage						
Typical output	rms		1.7 A	2.2 A	3.0 A	4.0 A		
	FLA		1.7 A	2.2 A	2.9 A	3.9 A		
Min. brake resistor	Accessories		240 Ω	190 Ω	140 Ω	100 Ω		
Pulse frequency	range	3 – 16 kHz						
	Factory setting	6 kHz						
Ambient temperature	S1		40 °C	40 °C.	40 °C.	40 °C.		
	S3 80 %, 10 min		50 °C.	50 °C.	50 °C.	50 °C.		
	S3 70 %, 10 min		50 °C.	50 °C.	50 °C.	50 °C.		
Type of ventilation		Free convection						
Weight	Approx. [kg]	1.6						
			General fuses (AC) (recommended)					
slow-blowing			6 / 6 A	6 / 6 A	10 / 6 A	10 / 6 A		
			UL fuses (AC) – permitted					
			Isc ¹⁾ [A]					
			5 000	10 000				
Class			100 000					
Fuse	J (600 V)	x			4 / 2.5 A	5 / 3.2 A	7 / 4.5 A	9 / 6 A
	CC, J, R, T, G, L (300 V)			x	6 / 6 A	6 / 6 A	10 / 10 A	25 / 10 A
	Bussmann LPJ-	x			4SP / 2.5SP	5SP / 3.2SP	7SP / 4.5SP	9SP / 6SP
CB	(480 V)		x		5 / 5 A	5 / 5 A	10 / 10 A	10 / 10 A

1) Maximum permissible mains overload current

Note: Fields with 2 values (separated by a forward slash) should be read as follows:

- The first value applies for a single phase mains connection
- The second value applies for a three-phase mains connection

Frequency inverter type		SK 5xxE...	-111-323-	-151-323-	-221-323-	-301-323-	-401-323-			
		Size	2	2	2	3	3			
Nominal motor power (4-pole standard motor)		230 V	1.1 kW	1.5 kW	2.2 kW	3.0 kW	4.0 kW			
		240 V	1½ hp	2 hp	3 hp	4 hp	5 hp			
Mains voltage		230 V	1 / 3 AC			3 AC				
			200 ... 240 V, ± 10 %, 47 ... 63 Hz							
Input current		rms	12.0 / 7.7 A	15.2 / 9.8 A	19.6 / 13.3 A	17.5 A	22.4 A			
		FLA	12.0 / 7.7 A	15.2 / 9.8 A	19.6 / 13.3 A	17.5 A	22.4 A			
Output voltage		230 V	3 AC 0 - Mains voltage							
Typical output		rms	5.5 A	7.0 A	9.5 A	12.5 A	16.0 A			
		FLA	5.4 A	6.9 A	8.8 / 9.3 A	12.3 A	15.7 A			
Min. brake resistor	Accessories		75 Ω	62 Ω	46 Ω	35 Ω	26 Ω			
Pulse frequency		range	3 – 16 kHz							
		Factory setting	6 kHz							
Ambient temperature		S1	40 °C.	40 °C.	40 °C.	40 °C.	40 °C.			
		S3 80 %, 10 min	50 °C.	50 °C.	50 °C.	-	-			
		S3 70 %, 10 min	50 °C.	50 °C.	50 °C.	50 °C.	50 °C.			
Type of ventilation			Fan cooling, temperature-controlled switching thresholds: ¹⁾ ON= 57°C OFF=47°C							
Weight	Approx. [kg]		2.0			2.7				
			General fuses (AC) (recommended)							
		slow-blowing	16 A / 10 A	16 A / 10 A	20 A / 16 A	20 A	25 A			
			UL fuses (AC) – permitted							
		Class	5 000	10 000	100 000					
Fuse		J (600 V)	x			13 / 8 A	17.5 / 10 A	20 / 15 A	17.5 A	25 A
		CC, J, R, T, G, L (300 V)			x	30 / 10 A	30 / 20 A	30 / 30 A	30 A	30 A
		Bussmann LPJ-	x			13SP / 8SP	17.5SP / 10SP	20SP / 15SP	17.5SP	25SP
CB		(480 V)		x		25 / 10 A	25 A	25 A	25 A	25 A

1) Brief test run after application of the mains voltage (for SK 5x5 inverters after application of the control voltage)

2) Maximum permissible mains overload current

Frequency inverter type		SK 5xxE...	-551-323-	-751-323-	-112-323-	-152-323-	-182-323-		
		Size	5	5	6	7	7		
Nominal motor power (4-pole standard motor)	230 V	5.5 kW	7.5 kW	11.0 kW	15.0 kW	18.5 kW			
	240 V	7½ hp	10 hp	15 hp	20 hp	25 hp			
Mains voltage	230 V	3 AC 200 ... 240 V, ± 10 %, 47 ... 63 Hz							
Input current	rms	30.8 A	39.2 A	64.4 A	84.0 A	102 A			
	FLA	30.8 A	39.2 A	58.8 A	66.6 A	83.8 A			
Output voltage	230 V	3 AC 0 - Mains voltage							
Typical output	rms	22.0 A	28.0 A	46.0 A	60.0 A	73.0 A			
	FLA	22 A	28 A	42 A	54 A	68 A			
Min. braking resistor	Accessories	19 Ω	14 Ω	10 Ω	7 Ω	6 Ω			
Pulse frequency	range	3 – 16 kHz							
	Factory setting	6 kHz							
Ambient temperature	S1	40 °C.	40 °C.	40 °C.	40 °C.	40 °C.			
	S3 80 %, 10 min	-	-	-	-	-			
	S3 70 %, 10 min	-	-	-	-	-			
Type of ventilation		Fan cooling, temperature-controlled switching thresholds: ¹⁾ ON= 57°C OFF=47°C							
Weight	Approx. [kg]	8		10.3	15				
		General fuses (AC) (recommended)							
slow-blowing		35 A	40 A	80 A	100 A	125 A			
		UL fuses (AC) – permitted							
		Isc ²⁾ [A]							
		5 000	65 000	100 000					
Class									
Fuse	(600 V)	x			30 A ³⁾	40 A ³⁾	60 A ³⁾	-	-
	CC, J, R, T (240 V)		x		30 A ³⁾	40 A ³⁾	60 A ³⁾	-	-
	CC, J, R, T, G, L (300 V)			x	-	-	-	100 A	100 A
	Bussmann LPJ-	x	x		30SP	40SP	60SP	-	-
CB	(240 V)		x		60 A ³⁾	60 A ³⁾	60 A ³⁾	-	-
	(480 V)	x			60 A ³⁾	60 A ³⁾	60 A ³⁾	-	-
	(480 V)			x				100 A	100 A

1) Short test run after connection of the mains voltage or control voltage

2) Maximum permissible mains overload current

3) According to mains voltage

7.3.3 Electrical data 400 V

Frequency inverter type		SK 5xxE...	-550-340-	-750-340-	-111-340-	-151-340-	-221-340-		
		Size	1	1	2	2	2		
Nominal motor power (4-pole standard motor)	400 V		0.55 kW	0.75 kW	1.1 kW	1.5 kW	2.2 kW		
	480 V		¾ hp	1 hp	1½ hp	2 hp	3 hp		
Mains voltage	400 V	3 AC 380 ... 480V, -20% / +10%, 47 ... 63 Hz							
Input current	rms		2.4 A	3.2 A	4.3 A	5.6 A	7.7 A		
	FLA		2.4 A	3.2 A	4.3 A	5.6 A	7.7 A		
Output voltage	400 V	3 AC 0 - Mains voltage							
Typical output	rms		1.7 A	2.3 A	3.1 A	4.0 A	5.5 A		
	FLA		1.5 A	2.1 A	2.8 A	3.6 A	4.9 A		
Min. brake resistor	Accessories		390 Ω	300 Ω	220 Ω	180 Ω	130 Ω		
Pulse frequency	range	3 – 16 kHz							
	Factory setting	6 kHz							
Ambient temperature	S1		40 °C.	40 °C.	40 °C.	40 °C.	40 °C.		
	S3 80 %, 10 min		50 °C.	50 °C.	50 °C.	50 °C.	50 °C.		
	S3 70 %, 10 min		50 °C.	50 °C.	50 °C.	50 °C.	50 °C.		
Type of ventilation			Free convection			Fan cooling, temperature-controlled switching thresholds: ¹⁾ ON= 57°C OFF=47°C			
Weight	Approx. [kg]		1.6		1.8				
			General fuses (AC) (recommended)						
slow-blowing			6 A	6 A	6 A	6 A	10 A		
			UL fuses (AC) – permitted						
			Isc ²⁾ [A]						
		Class	5 000	10 000	100 000				
Fuse	J (600 V)	x			2.5 A	3.5 A	4.5 A	6 A	8 A
	CC, J, R, T, G, L (600 V)			x	6 A	6 A	10 A	10 A	10 A
	Bussmann LPJ-	x			2.5SP	3.5SP	4.5SP	6SP	8SP
CB	(480 V)		x		5 A	5 A	10 A	10 A	10 A

1) Brief test run after application of the mains voltage (for SK 5x5 inverters after application of the control voltage)

2) Maximum permissible mains overload current

Frequency inverter type		SK 5xxE...	-301-340-	-401-340-	-551-340-	-751-340-		
		Size	3	3	4	4		
Nominal motor power (4-pole standard motor)	400 V		3.0 kW	4.0 kW	5.5 kW	7.5 kW		
	480 V		4 hp	5 hp	7½ hp	10 hp		
Mains voltage	400 V	3 AC 380 ... 480V, -20% / +10%, 47 ... 63 Hz						
Input current	rms		10.5 A	13.3 A	17.5 A	22.4 A		
	FLA		10.5 A	13.3 A	17.5 A	22.4 A		
Output voltage	400 V	3 AC 0 - Mains voltage						
Typical output	rms		7.5 A	9.5 A	12.5 A	16 A		
	FLA		6.7 A	8.5 A	11 A	14 A		
Min. brake resistor	Accessories		91 Ω	74 Ω	60 Ω	44 Ω		
Pulse frequency	range	3 – 16 kHz						
	Factory setting	6 kHz						
Ambient temperature	S1		40 °C.	40 °C.	40 °C.	40 °C.		
	S3 80 %, 10 min		-	-	50 °C.	50 °C.		
	S3 70 %, 10 min		50 °C.	50 °C.	50 °C.	50 °C.		
Type of ventilation		Fan cooling, temperature-controlled switching thresholds: ¹⁾ ON= 57°C OFF=47°C						
Weight	Approx. [kg]		2.7		3.1			
			General fuses (AC) (recommended)					
slow-blowing			16 A	16 A	20 A	25 A		
			UL fuses (AC) – permitted					
			Isc ²⁾ [A]					
			Class					
			5 000	10 000	100 000			
Fuse	J (600 V)	x			12 A	15 A	20 A	25 A
	CC, J, R, T, G, L (600 V)			x	25 A	30 A	30 A	30 A
	Bussmann LPJ-	x			12SP	15SP	20SP	25SP
CB	(480 V)		x		25 A	25 A	25 A	25 A

1) Brief test run after application of the mains voltage (for SK 5x5 inverters after application of the control voltage)

2) Maximum permissible mains overload current

Frequency inverter type		SK 5xxE...	-112-340-	-152-340-	-182-340-	-222-340-		
		Size	5	5	6	6		
Nominal motor power (4-pole standard motor)	400 V		11.0 kW	15.0 kW	18.5 kW	22.0 kW		
	480 V		15 hp	20 hp	25 hp	30 hp		
Mains voltage	400 V	3 AC 380 ... 480V, -20% / +10%, 47 ... 63 Hz						
Input current	rms		33.6 A	43.4 A	53.2 A	64.4 A		
	FLA		29.4 A	37.8 A	47.6 A	56 A		
Output voltage	400 V	3 AC 0 - Mains voltage						
Typical output	rms		24 A	31 A	38 A	46 A		
	FLA		21 A	27 A	34 A	40 A		
Min. brake resistor	Accessories		29 Ω	23 Ω	18 Ω	15 Ω		
Pulse frequency	range	3 – 16 kHz						
	Factory setting	6 kHz						
Ambient temperature	S1		40 °C.	40 °C.	40 °C.	40 °C.		
	S3 80 %, 10 min		-	-	-	-		
	S3 70 %, 10 min		-	-	-	-		
Type of ventilation		Fan cooling, temperature-controlled switching thresholds: ¹⁾ ON= 57°C OFF=47°C						
Weight	Approx. [kg]		8		10.3			
			General fuses (AC) (recommended)					
slow-blowing			35 A	50 A	63 A	80 A		
			UL fuses (AC) – permitted					
		Class	Isc ²⁾ [A]					
			5 000	65 000	100 000			
Fuse	(480 V)	x			40 A ³⁾	50 A ³⁾	60 A ³⁾	60 A ³⁾
	CC, J, R, T (480 V)		x		40 A ³⁾	50 A ³⁾	60 A ³⁾	60 A ³⁾
	Bussmann LPJ-	x	x		30SP	40SP	60SP	60SP
CB	(480 V)	x	x		60 A ³⁾	60 A ³⁾	60 A ³⁾	60 A ³⁾

1) Short test run after connection of the mains voltage or control voltage

2) Maximum permissible mains overload current

3) According to mains voltage

Frequency inverter type		SK 5xxE...	-302-340-	-372-340-	-452-340-	-552-340-	-752-340-		
		Size	7	7	8	8	9		
Nominal motor power (4-pole standard motor)		400 V	30.0 kW	37.0 kW	45.0 kW	55.0 kW	75.0 kW		
		480 V	40 hp	50 hp	60 hp	75 hp	100 hp		
Mains voltage		400 V	3 AC 380 ... 480V, -20% / +10%, 47 ... 63 Hz						
Input current		rms	84 A	105 A	126 A	154 A	210 A		
		FLA	64.1 A	80 A	108 A	134 A	174 A		
Output voltage		400 V	3 AC 0 - Mains voltage						
Typical output		rms	60 A	75 A	90 A	110 A	150 A		
		FLA	52 A	68 A	77 A	96 A	124 A		
Min. brake resistor		Accessories	9 Ω	9 Ω	8 Ω	8 Ω	6 Ω		
Pulse frequency		range	3 – 16 kHz		3 – 8 kHz				
		Factory setting	6 kHz		4 kHz				
Ambient temperature		S1	40 °C.	40 °C.	40 °C.	40 °C.	40 °C.		
		S3 80 %, 10 min	-	-	-	-	-		
		S3 70 %, 10 min	-	-	-	-	-		
Type of ventilation			Fan cooling, temperature-controlled switching thresholds: ¹⁾ ON= 57°C OFF=47°C ON= 56°C OFF=52°C						
		Fan speed control	between 47°C (52°C) and approx. 70°C ²⁾						
Weight		Approx. [kg]	16		20		25		
			General fuses (AC) (recommended)						
slow-blowing			100 A	125 A	160 A	160 A	224 A		
			UL fuses (AC) – permitted						
		Class	Isc ³⁾ [A]						
			10 000	65 000	100 000				
Fuse		RK5 (480 V)	x		-	-	125 A	150 A	200 A
		CC, J, R, T, G, L (600 V)		x	100 A	100 A	125 A	150 A	200 A
					-	-	-	-	-
CB		(480 V)	x	x	-	-	125 A	150 A	200 A
		(480 V)		x	100 A	100 A	-	-	-

1) Short test run after connection of the mains voltage or control voltage

2) In case of overload of the frequency inverter, the speed of the fan is increased to 100% regardless of the actual temperature of the device.

3) Maximum permissible mains overload current

Device type (Size 910 11):		SK 5xxE...	-902-340-	-113-340-	-133-340-	-163-340-			
		Size	9	10	10	11			
Nominal motor power (4-pole standard motor)	400 V	90.0 kW	110.0 kW	132.0 kW	160.0 kW				
	480 V	125 hp	150 hp	180 hp	220 hp				
Mains voltage	400 V	3 AC 380 ... 480V, -20% / +10%, 47 ... 63 Hz							
Input current	rms	252 A	308 A	364 A	448 A				
	FLA	218 A	252 A	300 A	370 A				
Output voltage	400 V	3 AC 0 - Mains voltage							
Output current	rms	180 A	220 A	260 A	320 A				
	FLA	156 A	180 A	216 A	264 A				
Min. brake resistor	Accessories	6 Ω	3.2 Ω	3.0 Ω	2.6 Ω				
Pulse frequency	range	3 – 8 kHz							
	Factory setting	4 kHz							
Ambient temperature	S1	40 °C.	40 °C.	40 °C.	40 °C.				
	S3 80 %, 10 min	-	-	-	-				
	S3 70 %, 10 min	-	-	-	-				
Type of ventilation	Fan cooling, temperature-controlled switching thresholds: ¹⁾ ON= 56°C OFF=52°C								
Fan speed control	Between 52°C and approx. 70°C ²⁾		there is no speed control! ³⁾						
Weight	Approx. [kg]	30	46	49	52				
			General fuses (AC) (recommended)						
slow-blowing			315 A	350 A	350 A	400 A			
			UL fuses (AC) – permitted						
		Isc ⁴⁾ [A]							
Class		10 000	18 000	65 000	100 000				
Fuse	RK5 (480 V)	x				250 A	-	-	-
	J (480 V)	x				-	350 A	350 A	-
	J (480 V)		x			-	-	-	400 A
	CC, J, R, T, G, L (600 V)				x	250 A	350 A	350 A	400 A
CB	(480 V)	x		x		250 A	-	-	-

1) Short test run after connection of the mains voltage or control voltage

2) In case of overload of the frequency inverter, the speed of the fan is increased to 100 % regardless of the actual temperature of the device.

3) The fans switch on sequentially (interval approx. 1.8 sec)

4) Maximum permissible mains overload current

7.4 General conditions for ColdPlate technology

The standard frequency inverter is supplied with a smooth flat mounting surface instead of a heat sink. This means that the FI must be cooled via the mounting surface, but has a low installation depth.

For all devices there is no fan.

In the selection of a suitable cooling system (e.g. liquid-cooled mounting plate) the thermal resistance R_{th} and the heat to be dissipated from the P_v modulus of the frequency inverter must be taken into account. For example, the supplier of the appropriate control cabinet system can provide details for the correct selection of the mounting plate.

The mounting plate has been correctly selected if its R_{th} value is less than the values stated below.



NOTE:

Before the device is fitted to the mounting plate, any protective film must be removed. A suitable heat-conducting paste must be used.

1~ 115V - devices	Pv module [W]	Max. Rth [K/W]	Cooling area [m ²] ¹⁾
SK 5xxE-250-112-O-CP	12.0	2.33	0.12
SK 5xxE-250-112-O-CP	16.5	1.70	0.17
SK 5xxE-550-112-O-CP	23.9	1.17	0.24
SK 5xxE-750-112-O-CP	35.7	0.78	0.36
SK 5xxE-111-112-O-CP	53.5	0.39	0.54

1) Required cooling area, determined under the following general conditions: Control cabinet, height approx. 2 m, ventilation by free convection, mounting plate: Galvanised sheet steel, not painted, thickness approx. 3 mm.

Table 29: Technical data, ColdPlate 115V devices

230V - devices Single phase operation	Pv module [W]	Max. Rth [K/W]	Cooling area [m ²] ¹⁾
SK 5xxE-250-323-A-CP	13.6	2.05	0.14
SK 5xxE-370-323-A-CP	18.5	1.52	0.19
SK 5xxE-550-323-A-CP	26.9	1.04	0.27
SK 5xxE-750-323-A-CP	38.8	0.72	0.39
SK 5xxE-111-323-A-CP	59.4	0.35	0.6
SK 5xxE-151-323-A-CP	72.1	0.29	0.73
SK 5xxE-221-323-A-CP ²⁾	87.9	0.24	0.88

1) Required cooling area, determined under the following general conditions: Control cabinet, height approx. 2 m, ventilation by free convection, mounting plate: Galvanised sheet steel, not painted, thickness approx. 3 mm.

2) In contrast to the standard device the SK 5xxE-221-323-A-CP is only available in size 3 for S1-operation.

Table 30: Technical data, ColdPlate 230V devices, single phase operation

230V - devices 3 phase operation	Pv module [W]	Max. Rth [K/W]	Cooling area [m ²] ¹⁾
SK 5xxE-750-323-A-CP	37.3	0.75	0.38
SK 5xxE-111-323-A-CP	56.7	0.37	0.57
SK 5xxE-151-323-A-CP	67.7	0.31	0.68
SK 5xxE-221-323-A-CP ²⁾	94.2	0.22	0.95
SK 5xxE-301-323-A-CP	107.5	0.20	1.08
SK 5xxE-401-323-A-CP	147.7	0.14	1.48

1) Required cooling area, determined under the following general conditions: Control cabinet, height approx. 2 m, ventilation by free convection, mounting plate: Galvanised sheet steel, not painted, thickness approx. 3 mm.

2) In contrast to the standard device the SK 5xxE-221-323-A-CP is only available in size 3 for S1-operation.

Table 31: Technical data, ColdPlate 230V devices, three phase operation

3~ 400V- devices	Pv module [W]	Max. Rth [K/W]	Cooling area [m ²] ¹⁾
SK 5xxE-550-340-A-CP	15.7	1.78	0.16
SK 5xxE-750-340-A-CP	22.0	1.27	0.23
SK 5xxE-111-340-A-CP	31.1	0.90	0.32
SK 5xxE-151-340-A-CP	42.1	0.66	0.43
SK 5xxE-221-340-A-CP	62.6	0.45	0.63
SK 5xxE-301-340-A-CP	85.7	0.25	0.86
SK 5xxE-401-340-A-CP	115.3	0.18	1.16
SK 5xxE-551-340-A-CP	147.7	0.15	1.48
SK 5xxE-751-340-A-CP	178.0	0.12	1.78

1) Required cooling area, determined under the following general conditions: Control cabinet, height approx. 2 m, ventilation by free convection, mounting plate: Galvanised sheet steel, not painted, thickness approx. 3 mm.

Table 32: Technical data, ColdPlate 400V devices

The following points must be complied with to ensure the R_{th} :

- The maximum heat sink temperature (T_{kk}) of 70°C and the maximum internal temperature of the control cabinet (T_{amb}) of 40°C must not be exceeded. Suitable cooling must be ensured.
- For installation in a control cabinet, the heat distribution must be taken into account, so that the available cooling area is used to the maximum extent. Through convection, the air on the rear side of the cooling surface heats the upper area more than the area under the source of heat. The device should therefore be mounted in the lower area of the control cabinet to achieve optimum use of the cooling surface.
- The ColdPlate and the mounting plate must lie flat against each other (max.air gap 0.05 mm).
- The contact area of the mounting plate must be at least as large as the area of the ColdPlate
- A suitable heat conducting paste must be applied between the ColdPlate and the mounting plate.
 - The heat conducting paste is not included in the scope of delivery!
 - First remove any protective film.
- All screw connections must be tightened.

When designing a cooling system the heat to be dissipated by the ColdPlate device, (P_v-module) must be taken into account. For the design of the control cabinet the heat production of the device of approx. 2% of the nominal power must be taken into account.

In case of any further queries, please contact Getriebebau NORD.

8 Additional information

8.1 Setpoint processing

Illustration of setpoint processing for SK 500E...SK 535E devices. This should be used analogously for SK 540E devices.

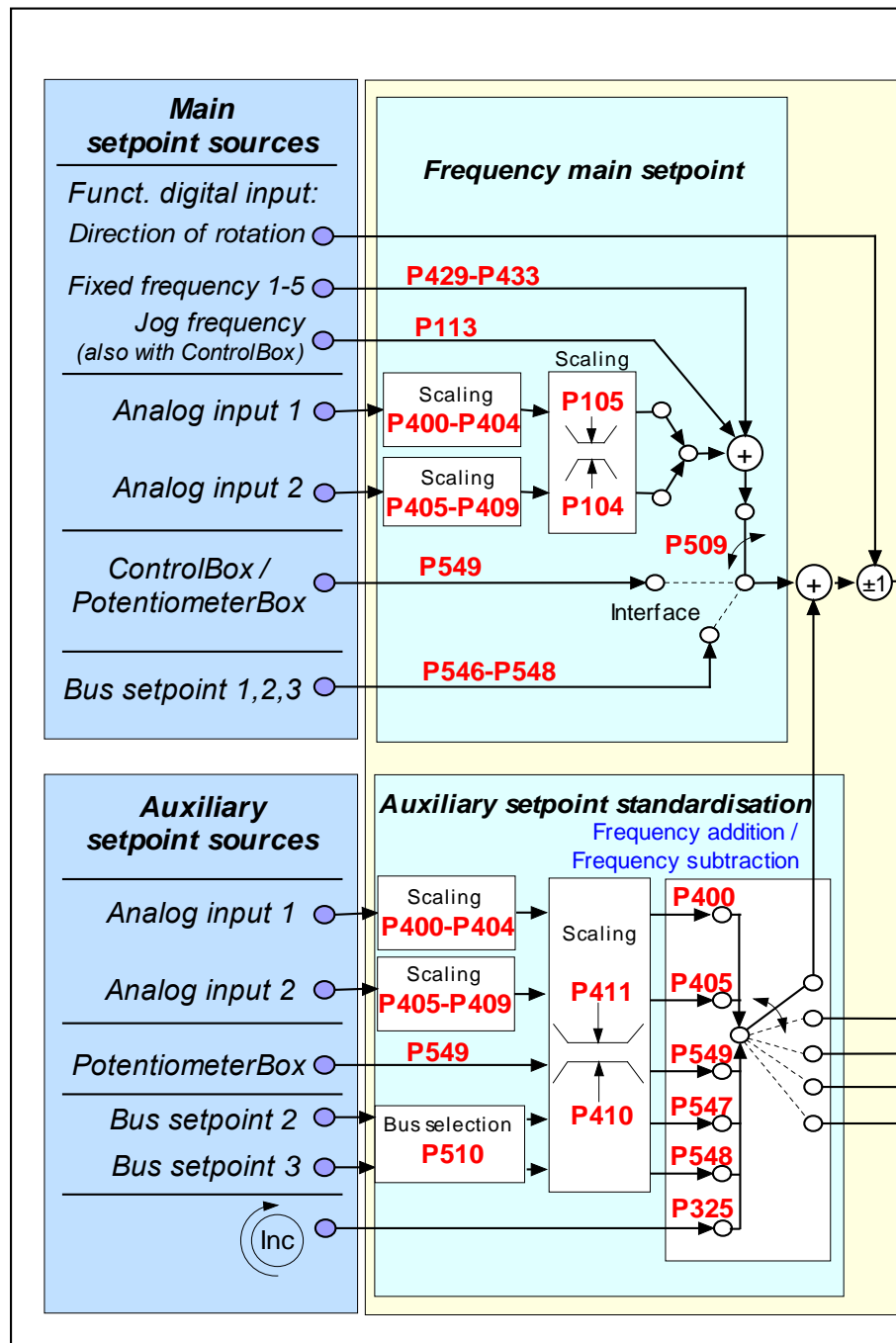

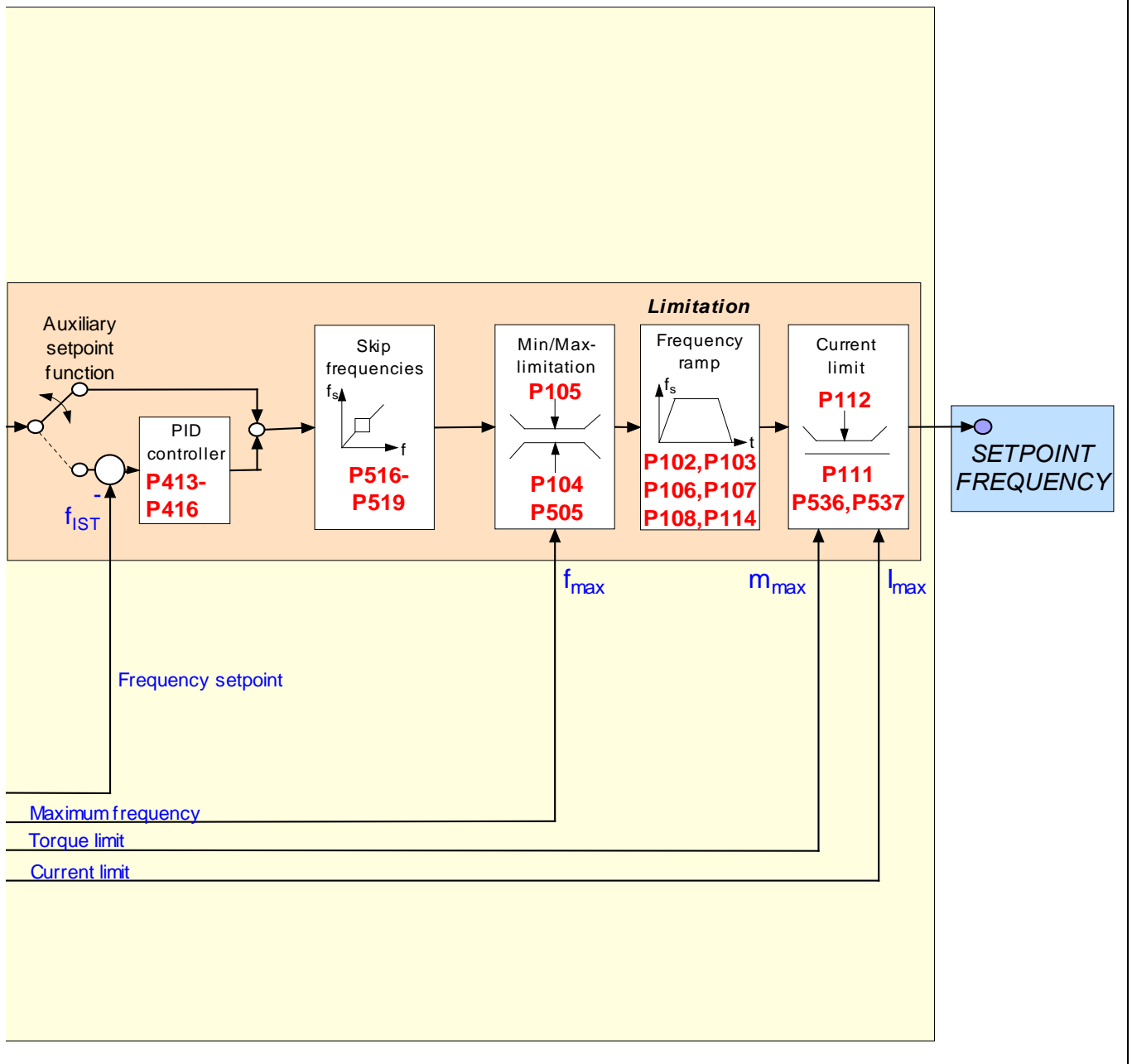

Fig. 14: Setpoint processing

8.2 Process controller

The process controller is a PI controller which can be used to limit the controller output. In addition, the output is scaled as a percentage of a master setpoint. This provides the option of controlling any downstream drives with the master setpoint and readjusting using the PI controller.

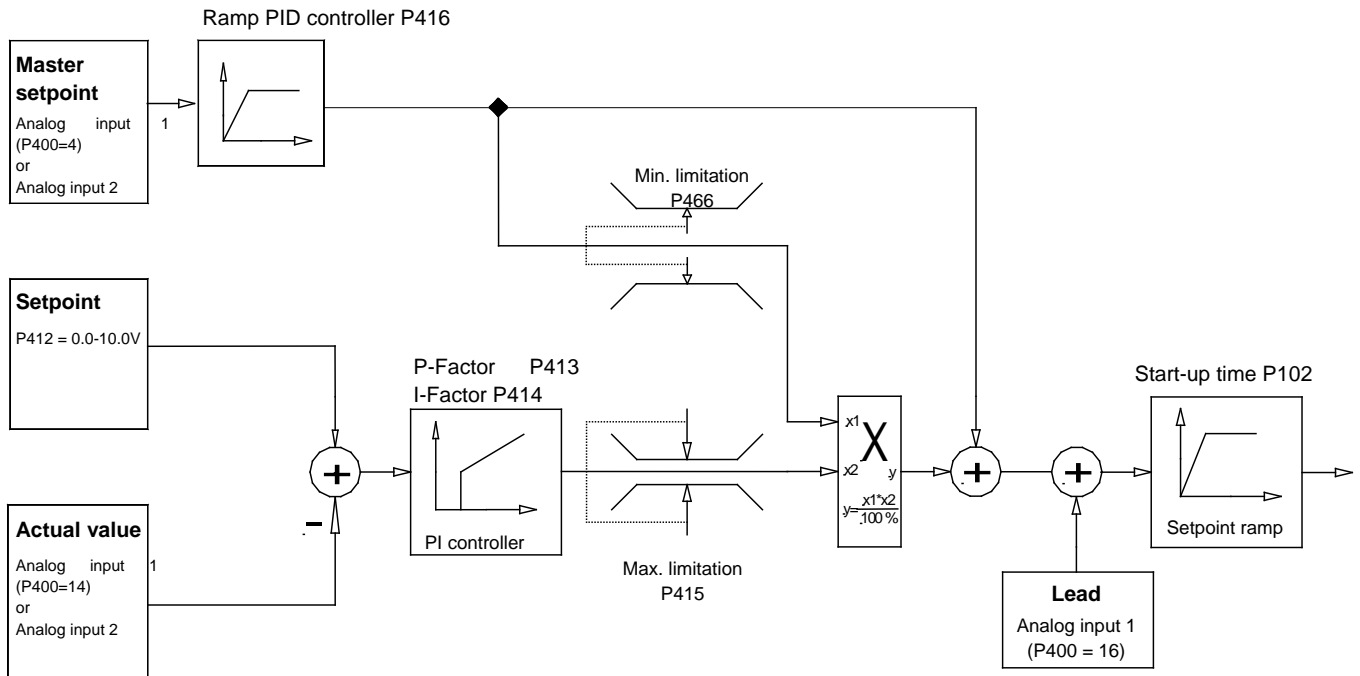
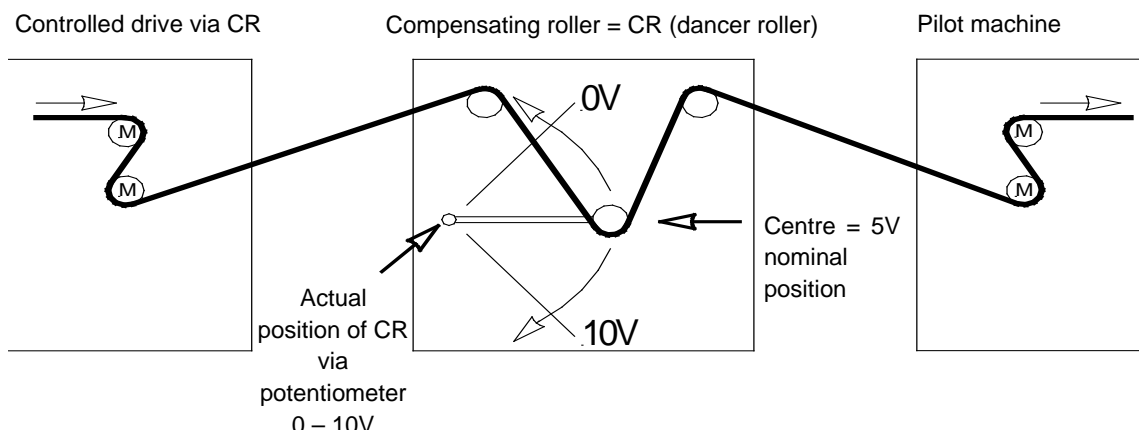
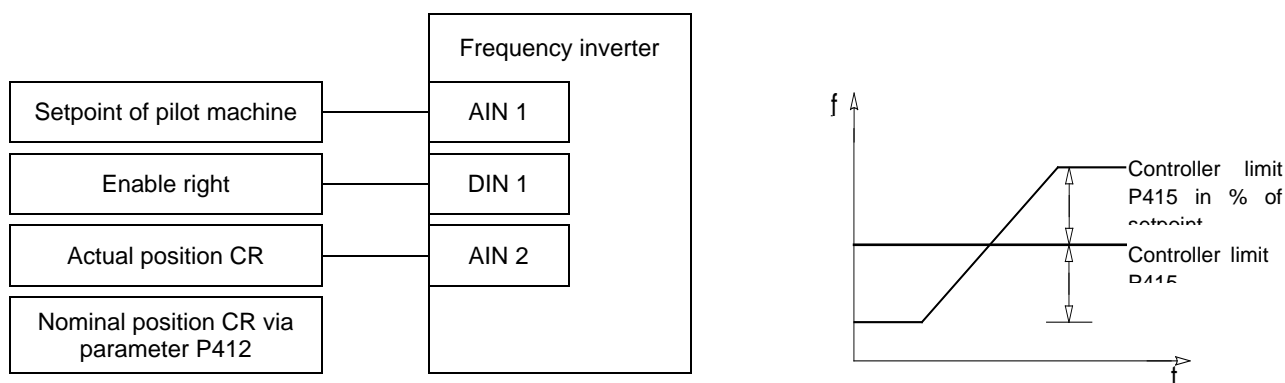

Fig. 15: Process controller flow diagram

8.2.1 Process controller application example





8.2.2 Process controller parameter settings

Example: SK 500E, setpoint frequency: 50 Hz, control limits: +/- 25%

$$P105 \text{ (maximum frequency) [Hz]} \geq \text{Setpointfreq. [Hz]} + \left(\frac{\text{Setpointfreq. [Hz]} \times P415 [\%]}{100\%} \right)$$

$$\text{Example: } \geq 50\text{Hz} + \frac{50\text{Hz} \times 25\%}{100\%} = \mathbf{62.5\text{Hz}}$$

P400 (Funct. analog input): „4“ (frequency addition)

P411 (setpoint frequency) [Hz] Set frequency with 10 V at analog input 1
Example: **50 Hz**

P412 (Process controller setpoint): CR middle position / Default setting **5V** (adjust if necessary)

P413 (P controller) [%]: Factory setting **10%** (adjust if necessary)

P414 (I-controller) [% / ms]: recommended **100%/s**

P415 (limitation +/-) [%] Controller limitation (see above)

Note:

In the function process controller, parameter P415 is used as a controller limiter downstream from the PI controller. This parameter therefore has a double function.

Example: **25%** of setpoint

P416 (ramp before controller) [s]: Factory setting **2s** (if necessary, adjust to match controller behaviour)

P420 (Funct. digital input 1): "1" Enable right

P405 (Funct. Analoginput 2): „14“ actual value PID process controller

8.3 Electromagnetic compatibility (EMC)

If the device is installed according to the recommendations in this manual, it meets all EMC directive requirements, as per the EMC product standard EN 61800-3.

8.3.1 General Provisions

As of July 2007, all electrical equipment which has an intrinsic, independent function and which is sold as an individual unit for end users, must comply with Directive 2004/108/EEC (formerly Directive EEC/89/336). There are three different ways for manufacturers to indicate compliance with this directive:

1. *EC Declaration of Conformity*

This is a declaration from the manufacturer, stating that the requirements in the applicable European standards for the electrical environment of the equipment have been met. Only those standards which are published in the Official Journal of the European Community may be cited in the manufacturer's declaration.

2. *Technical documentation*

Technical documentation can be produced which describes the EMC characteristics of the device. This documentation must be authorised by one of the "Responsible bodies" named by the responsible European government. This makes it possible to use standards which are still in preparation.

3. *EC Type test certificate*

This method only applies to radio transmitter equipment.

The devices only have an intrinsic function when they are connected to other equipment (e.g. to a motor). The base units cannot therefore carry the CE mark that would confirm compliance with the EMC directive. Precise details are therefore given below about the EMC behaviour of this product, based on the proviso that it is installed according to the guidelines and instructions described in this documentation.

The manufacturer can certify that his equipment meets the requirements of the EMC directive in the relevant environment with regard to their EMC behaviour in power drives. The relevant limit values correspond to the basic standards EN 61000-6-2 and EN 61000-6-4 for interference immunity and interference emissions.

8.3.2 EMC evaluation

Two standards must be observed when evaluating electromagnetic compatibility.

1. *EN 55011-1 (environmental standard)*

The limits are defined in dependence on the basic environment in which the product is operated in this standard. A distinction is made between 2 environments, whereby the **1st environment** describes the non-industrial **living and business area** without its own high-voltage or medium-voltage distribution transformers. The **2nd environment**, on the other hand, defines **industrial areas** which are not connected to the public low-voltage network, but have their own high-voltage or medium-voltage distribution transformers. The limits are subdivided into **classes A1, A2 and B**.

2. *EN 61800-3 (product standard)*

The limits are defined in dependence on the usage area of the product in this standard. The limits are subdivided into **categories C1, C2, C3 and C4**, whereby class C4 basically only applies to drive systems with higher voltage (≥ 1000 V AC), or higher currents (≥ 400 A). However, class C4 can also apply to the individual device if it is incorporated in complex systems.

The same limits apply to both standards: However, the standards differ with regard to an application that is extended in the product standard. The user decides which of the two standards applies, whereby the environmental standard applies in the event of a typical fault remedy.

The main connection between the two standards is explained as follows:

Category as per EN 61800-3	C1	C2	C3
Limit class in accordance with EN 55011	B	A1	A2
Operation permissible in			
1. Environment (living environment)	X	X ¹⁾	-
2. Environment (industrial environment)	X	X ¹⁾	X ¹⁾
Note required in accordance with EN-61800-3	-	2)	3)
Sales channel	Generally available	Limited availability	
EMC situation	No requirements	Installation and start-up by EMC expert	
1) Device used neither as a plug-in device nor in moving equipment 2) "The drive system can cause high-frequency interference in a living environment that may make interference suppression measures necessary". 3) "The drive system is not intended for use in a public low-voltage network that feeds residential areas".			

Table 33: EMC comparison between EN 61800-3 and EN 55011

8.3.3 EMC of device

NOTICE

EMC

The drive system can cause high-frequency interference in a living environment that may make interference suppression measures necessary.

The device is exclusively intended for commercial use. It is therefore not subject to the requirements of the standard EN 61000-3-2 for radiation of harmonics.

The limit value classes are only achieved if

- the wiring is EMC-compliant
- the length of the shielded motor cable does not exceed the permissible limits

The motor cable shielding must be applied on both sides (frequency inverter shield angle and the metal motor terminal box). Depending on the inverter version (...-A or ...-O) and according to the type and use of mains filters or chokes, different permissible motor cable lengths result for compliance with the declared limit value classes.

i Information

Shielded motor cable > 30 m

For connection of shielded motor cables with a length > 30 m, in particular with low power frequency inverters the current monitoring may trigger, so that use of an output choke (SK CO1-...) is also necessary.

Inverter type	Jumper position / DIP: "EMC-Filter" (chapter 2.9.2)	Conducted emissions 150 kHz - 30 MHz	
		Class C2	Class C1
SK 5xxE-250-323-A ... SK 5xxE-401-323-A	3 – 2	20 m	5 m
	3 – 3	5 m	-
SK 5x5E-551-323-A ... SK 5x5E-182-323-A	4 – 2	20 m	-
SK 5xxE-550-340-A ... SK 5xxE-751-340-A	3 – 2	20 m	5 m
	3 – 3	5 m	-
SK 5xxE-550-340-A ... SK 5xxE-751-340-A + suitable bottom-mounted combination filter SK NHD-...	3 – 2	100 m	50 m
SK 5xxE-550-340-O ... SK 5xxE-751-340-O + suitable bottom-mounted combination filter SK NHD-...	3 – 2	100 m	25 m
SK 5x5E-112-340-A ... SK 5x5E-372-340-A	4 – 2	20 m	-
SK 5x5E-112-340-A ... SK 5x5E-372-340-A + suitable bottom-mounted SK LF2-...	4 – 2	100 m	50 m
SK 5x5E-112-340-O ... SK 5x5E-372-340-O + suitable bottom-mounted SK LF2-...	4 – 2	100 m	25 m
SK 5x5E-452-340-A ... SK 5x5E-163-340-A	DIP: ON	20 m	-

Table 34: EMC, max. shielded motor cable length with regard to compliance with the limit value classes

EMC overview of standards that are used in accordance with EN 61800-3 as checking and measuring procedures:		
<i>Interference emission</i>		
Cable-related emission (interference voltage)	EN 55011	C2
		C1 (BG 1-4)
Radiated emission (interference field strength)	EN 55011	C2
		-
<i>Interference immunity EN 61000-6-1, EN 61000-6-2</i>		
ESD, discharge of static electricity	EN 61000-4-2	6 kV (CD), 8 kV (AD)
EMF, high frequency electro-magnetic fields	EN 61000-4-3	10 V/m; 80 – 1000 MHz
Burst on control cables	EN 61000-4-4	1 kV
Burst on mains and motor cables	EN 61000-4-4	2 kV
Surge (phase-phase / phase-ground)	EN 61000-4-5	1 kV / 2 kV
Cable-led interference due to high frequency fields	EN 61000-4-6	10 V, 0.15 – 80 MHz
Voltage fluctuations and drops	EN 61000-2-1	+10 %, -15 %; 90 %
Voltage asymmetries and frequency changes	EN 61000-2-4	3 %; 2 %

Table 35: Overview according to product standard EN 61800-3

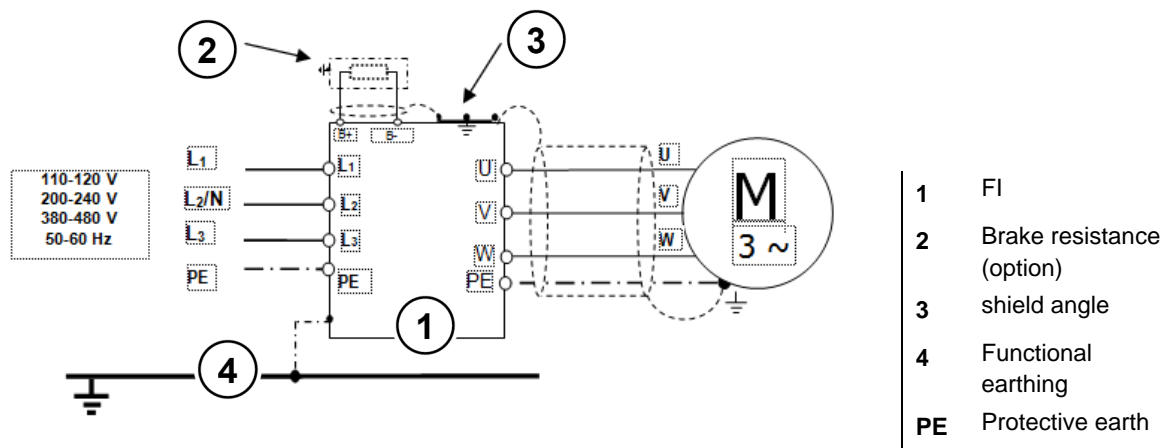





Figure 16: Wiring recommendation

8.3.4 EC Declaration of Conformity

																									
GETRIEBEBAU NORD Member of the NORD DRIVESYSTEMS Group																									
Getriebebau NORD GmbH & Co. KG <small>Getriebebau-Nord-Str. 1 · 22941 Bargteheide, Germany · Fon +49(0)4532 289 - 0 · Fax +49(0)4532 289 - 2253 · info@nord.com</small>																									
C310600_1021																									
EU Declaration of Conformity <small>In the meaning of the EU directives 2014/35/EU Annex IV, 2014/30/EU Annex II, 2009/125/EG Annex IV and 2011/65/EU Annex VI</small>																									
<p>Getriebebau NORD GmbH & Co. KG as manufacturer in sole responsibility hereby declares, Page 1 of 1</p> <p>that the variable speed drives of the product series NORDAC PRO</p> <ul style="list-style-type: none"> • SK 500E-xxx-123-B-.. , SK 500E-xxx-323-.-.. , SK 500E-xxx-340-.-.. , SK 500E-xxx-350-.-.. <small>(xxx= 250, 370, 550, 750, 111, 151, 221, 301, 401, 551, 751, 112, 152, 182, 222, 302, 372, 452, 552, 752, 902, 113, 133, 163, 203)</small> also in these functional variants: SK 501E-..., SK 505E-..., SK 510E-..., SK 511E-..., SK 515E-..., SK 520E-..., SK 525E-..., SK 530E-..., SK 531E-..., SK 535E-..., SK 540E-..., SK 545E-... <p>and the further options/accessories: SK TU3-..., SK PAR-3. , SK CSX-3. , SK SSX-3A, SK POT1-. , SK EBIOE-2, SK EBGR-1, SK TIES-BT-STICK, SK-EMC 2-. , SK DRK1-1, SK TH1-. , SK CI1-.... , SK CO1-.... , SK CIF-... , SK NHD-... , SK LF2-... , HLD 110-500/.. , SK DCL-950/... , SK BR.-... </p> <p>comply with the following regulations:</p> <table border="0"> <tr> <td>Low Voltage Directive</td> <td>2014/35/EU</td> <td>OJ. L 96 of 29.3.2014, p. 357–374</td> </tr> <tr> <td>EMC Directive</td> <td>2014/30/EU</td> <td>OJ. L 96 of 29.3.2014, p. 79–106</td> </tr> <tr> <td>Ecodesign Directive</td> <td>2009/125/EG</td> <td>OJ. L 285 of 31.10.2009, p. 10–35</td> </tr> <tr> <td>Regulation (EU) Ecodesign</td> <td>2019/1781</td> <td>OJ. L 272 of 25.10.2019, p. 74–94</td> </tr> <tr> <td>RoHS Directive</td> <td>2011/65/EU</td> <td>OJ. L 174 of 1.7.2011, p. 88–11</td> </tr> <tr> <td>Delegated Directive (EU)</td> <td>2015/863</td> <td>OJ. L 137 of 4.6.2015, p. 10–12</td> </tr> </table> <p>Applied standards:</p> <table border="0"> <tr> <td>EN 61800-5-1:2007+A1:2017</td> <td>EN 61800-3:2018</td> <td>EN 61800-9-1:2017</td> </tr> <tr> <td>EN 60529:1991+A1:2000+A2:2013+AC:2016</td> <td>EN 63000:2018</td> <td>EN 61800-9-2:2017</td> </tr> </table> <p>It is necessary to notice the data in the operating manual to meet the regulations of the EMC-Directive. Specially take care about correct EMC installation and cabling, differences in the field of applications and if necessary original accessories.</p> <p>First marking was carried out in 2005.</p> <p>Bargteheide, 12.03.2021</p> <div style="display: flex; justify-content: space-around; margin-top: 20px;"> <div style="text-align: center;">  <p>U. Küchenmeister Managing Director</p> </div> <div style="text-align: center;">  <p>pp F. Wiedemann Head of Inverter Division</p> </div> </div>		Low Voltage Directive	2014/35/EU	OJ. L 96 of 29.3.2014, p. 357–374	EMC Directive	2014/30/EU	OJ. L 96 of 29.3.2014, p. 79–106	Ecodesign Directive	2009/125/EG	OJ. L 285 of 31.10.2009, p. 10–35	Regulation (EU) Ecodesign	2019/1781	OJ. L 272 of 25.10.2019, p. 74–94	RoHS Directive	2011/65/EU	OJ. L 174 of 1.7.2011, p. 88–11	Delegated Directive (EU)	2015/863	OJ. L 137 of 4.6.2015, p. 10–12	EN 61800-5-1:2007+A1:2017	EN 61800-3:2018	EN 61800-9-1:2017	EN 60529:1991+A1:2000+A2:2013+AC:2016	EN 63000:2018	EN 61800-9-2:2017
Low Voltage Directive	2014/35/EU	OJ. L 96 of 29.3.2014, p. 357–374																							
EMC Directive	2014/30/EU	OJ. L 96 of 29.3.2014, p. 79–106																							
Ecodesign Directive	2009/125/EG	OJ. L 285 of 31.10.2009, p. 10–35																							
Regulation (EU) Ecodesign	2019/1781	OJ. L 272 of 25.10.2019, p. 74–94																							
RoHS Directive	2011/65/EU	OJ. L 174 of 1.7.2011, p. 88–11																							
Delegated Directive (EU)	2015/863	OJ. L 137 of 4.6.2015, p. 10–12																							
EN 61800-5-1:2007+A1:2017	EN 61800-3:2018	EN 61800-9-1:2017																							
EN 60529:1991+A1:2000+A2:2013+AC:2016	EN 63000:2018	EN 61800-9-2:2017																							

8.4 Reduced output power

The frequency inverters are designed for certain overload situations. For example, 1.5x overcurrent can be used for 60 s. For approx. 3.5 s a 2x overcurrent is possible. A reduction of the overload capacity or its time must be taken into account in the following circumstances:

- Output frequencies < 4.5 Hz and constant voltages (needle stationary)
- Pulse frequencies greater than the nominal pulse frequency (P504)
- Increased mains voltage > 400 V
- Increased heat sink temperature

On the basis of the following characteristic curves, the particular current / power limitation can be read off.

8.4.1 Increased heat dissipation due to pulse frequency

This illustration shows how the output current must be reduced, depending on the pulse frequency for 230V and 400V devices, in order to avoid excessive heat dissipation in the frequency inverter.

For 400V devices, the reduction begins at a pulse frequency above 6kHz (\geq size 8: above 4kHz). For 230V devices, the reduction begins at a pulse frequency above 8kHz.

Even with increased pulse frequencies the frequency inverter is capable of supplying its maximum peak current, however only for a reduced period of time. The diagram shows the possible current load capacity for continuous operation.

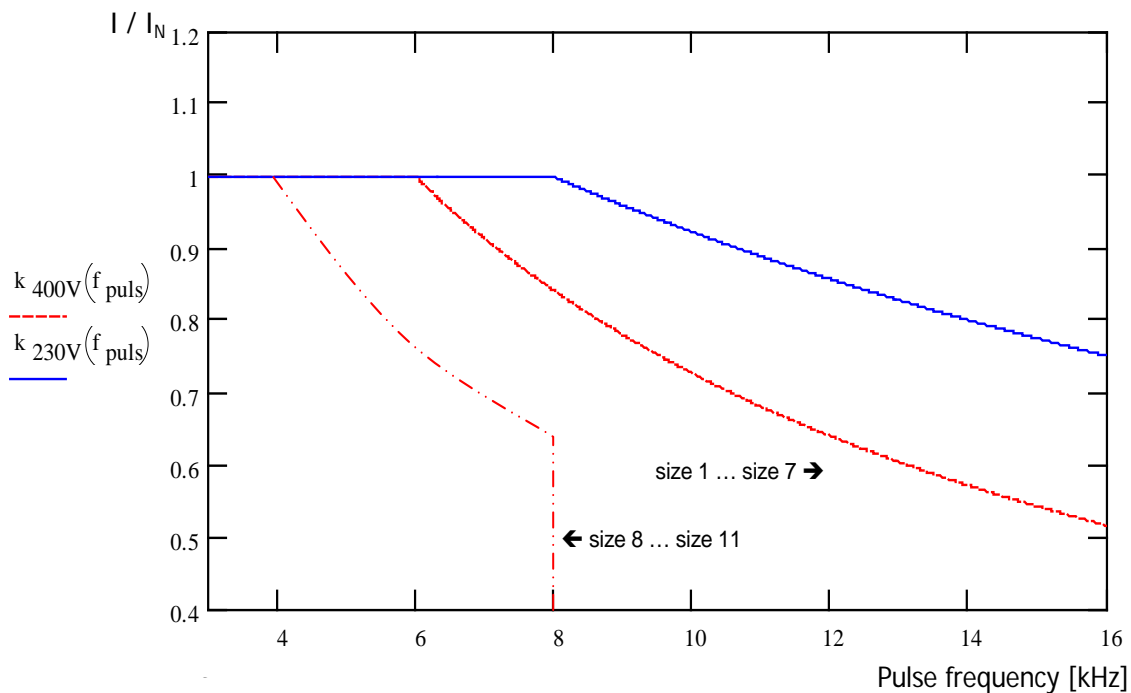

Figure 17: Heat losses due to pulse frequency

8.4.2 Reduced overcurrent due to time

The possible overload capacity changes depending on the duration of an overload. Several values are cited in this table. If one of these limiting values is reached, the frequency inverter must have sufficient time (with low utilisation or without load) in order to regenerate itself.

If operated repeatedly in the overload region at short intervals, the limiting values stated in the tables are reduced.

230V devices: Reduced overload capacity (approx.) due to pulse frequency (P504) and time						
Pulse frequency [kHz]	Time [s]					
	> 600	60	30	20	10	3.5
3...8	110%	150%	170%	180%	180%	200%
10	103%	140%	155%	165%	165%	180%
12	96%	130%	145%	155%	155%	160%
14	90%	120%	135%	145%	145%	150%
16	82%	110%	125%	135%	135%	140%

400V devices: Reduced overload capacity (approx.) due to pulse frequency (P504) and time						
Pulse frequency [kHz]	Time [s]					
	> 600	60	30	20	10	3.5
3...6	110%	150%	170%	180%	180%	200%
8	100%	135%	150%	160%	160%	165%
10	90%	120%	135%	145%	145%	150%
12	78%	105%	120%	125%	125%	130%
14	67%	92%	104%	110%	110%	115%
16	57%	77%	87%	92%	92%	100%

Table 36: Overcurrent relative to time

8.4.3 Reduced overcurrent due to output frequency

To protect the power unit at low output frequencies (<4.5Hz) a monitoring system is provided, with which the temperature of the IGBTs (*integrated gate bipolar transistor*) due to high current is determined. In order to prevent current being taken off above the limit shown in the diagram, a pulse switch-off (P537) with a variable limit is introduced. At a standstill, with 6kHz pulse frequency, current above 1.1x the nominal current cannot be taken off.

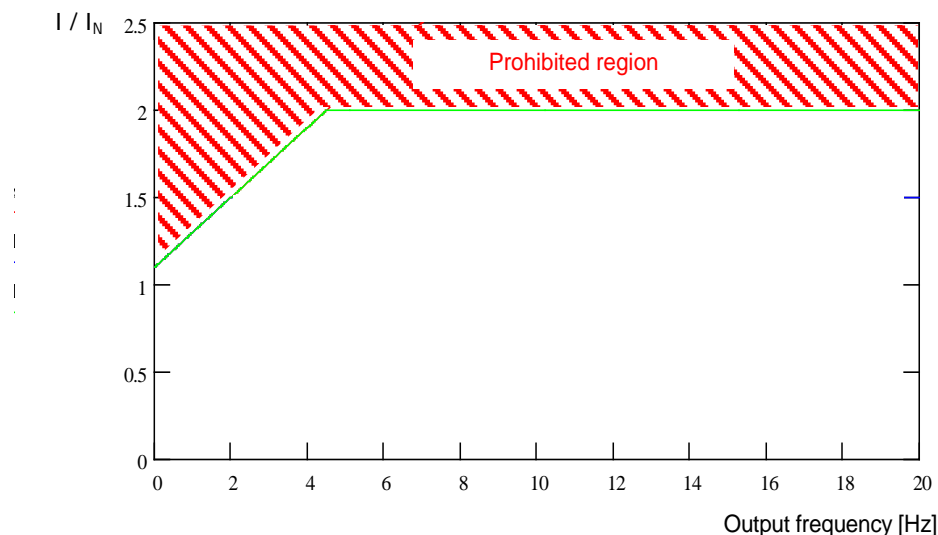

The upper limiting values for the various pulse frequencies can be obtained from the following tables. In all cases, the value (0.1...1.9) which can be set in parameter P537, is limited to the value stated in the tables according to the pulse frequency. Values below the limit can be set as required.

230V devices: Reduced overload capacity (approx.) due to pulse frequency (P504) and output frequency							
Pulse frequency [kHz]	Output frequency [Hz]						
	4.5	3.0	2.0	1.5	1.0	0.5	0
3...8	200%	170%	150%	140%	130%	120%	110%
10	180%	153%	135%	126%	117%	108%	100%
12	160%	136%	120%	112%	104%	96%	95%
14	150%	127%	112%	105%	97%	90%	90%
16	140%	119%	105%	98%	91%	84%	85%

400V devices: Reduced overload capacity (approx.) due to pulse frequency (P504) and output frequency							
Pulse frequency [kHz]	Output frequency [Hz]						
	4.5	3.0	2.0	1.5	1.0	0.5	0
3...6	200%	170%	150%	140%	130%	120%	110%
8	165%	140%	123%	115%	107%	99%	90%
10	150%	127%	112%	105%	97%	90%	82%
12	130%	110%	97%	91%	84%	78%	71%
14	115%	97%	86%	80%	74%	69%	63%
16	100%	85%	75%	70%	65%	60%	55%

Table 37: Overcurrent relative to pulse and output frequency

8.4.4 Reduced output current due to mains voltage

The devices are designed with thermal characteristics according to the nominal output currents. Accordingly, for lower mains voltages, higher currents cannot be taken off in order to maintain the stated power constant. For mains voltages above 400 V there is a reduction of the permissible continuous output current, which is inversely proportional to the mains voltage, in order to compensate for the increased switching losses.

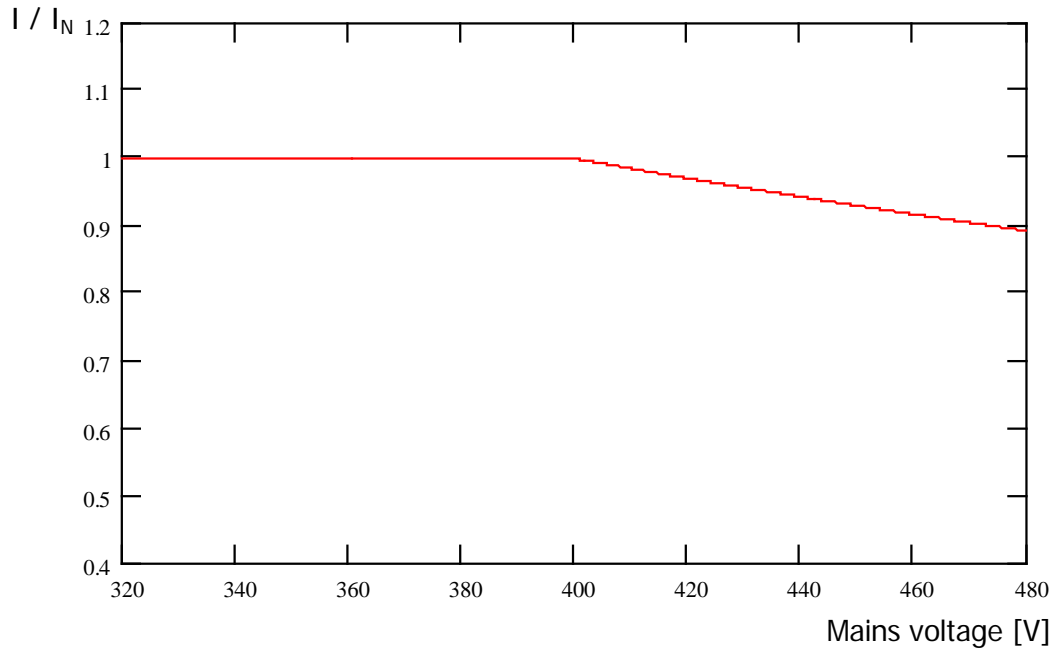

Figure 18: Output current due to mains voltage

8.4.5 Reduced output current due to the heat sink temperature

The temperature of the heat sink is included in the calculation of the reduction of output current, so that at low heat sink temperatures, a higher load capacity can be permitted, especially for higher pulse frequencies. At high heat sink temperatures, the reduction is increased correspondingly. The ambient temperature and the ventilation conditions for the device can therefore be optimally exploited.

8.5 Operation with FI circuit breakers

SK 5xxE frequency inverters are designed for operation with a 30mA all-current sensitive FI circuit breaker. If several frequency inverters are operated on a single FI circuit breaker, the leakage currents to earth must be reduced. For further details, please refer to Section **Fehler! Verweisquelle konnte nicht gefunden werden.**

8.6 Energy Efficiency

NORD frequency inverters have a low power consumption and are therefore highly efficient. In addition, with the aid of "Automatic flux optimisation" (Parameter (P219)) the inverter provides a possibility for increasing the overall efficiency of the drive in certain applications (in particular applications with partial load).

According to the torque required, the magnetisation current through the frequency inverter or the motor torque is reduced to the level which is required for the momentary drive power. The resulting considerable reduction in power consumption, as well as the optimisation of the $\cos \varphi$ factor of the motor rating in the partial load range contributes to creating optimum conditions both with regard to energy consumption and mains characteristics.

A parameterisation which is different from the factory setting (Factory setting = 100%) is only permissible for applications which do not require rapid torque changes. (For details, see Parameter (P219))

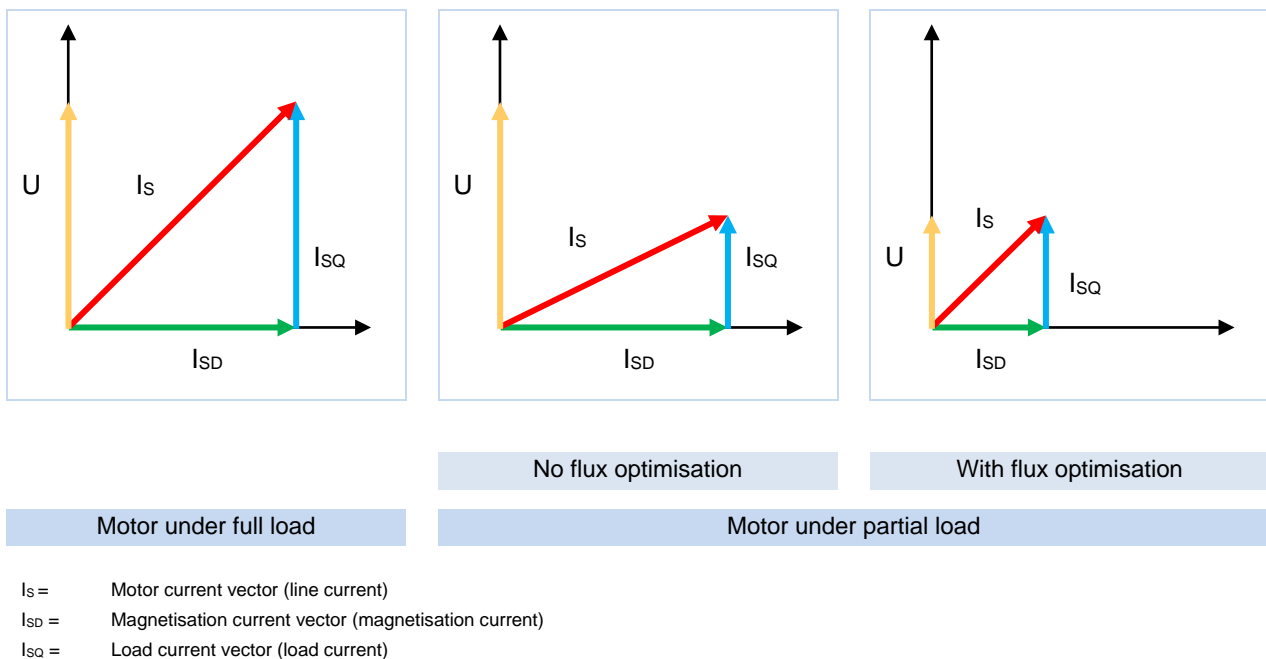

Figure 19: Energy efficiency due to automatic flux optimisation

WARNING

Overload

This function is not suitable for lifting gear applications or applications with frequent, large load changes, and the factory setting (100%) of parameter (P219) must not be changed. If this is not observed, there is a danger that the motor will break down in a sudden peak load occurs.

8.7 Standardisation of setpoint / target values

The following table contains details for the standardisation of typical setpoint and actual values. These details relate to parameters (P400), (P418), (P543), (P546), (P740) or (P741).

Name Setpoint values {Function}	Analog signal		Bus signal						Limitation absolute
	Value range	Standardisation	Value range	Max.val ue	Type	100% =	-100% =	Standardisation	
Setpoint frequency {01}	0-10V (10V=100%)	P104 ... P105 (min - max)	±100%	16384	INT	4000 _{hex} 16384 _{dez}	C000 _{hex} .16385 _{dez}	4000 _{hex} * f _{setpoint} [Hz]/P105	P105
Frequency addition {04}	0-10V (10V=100%)	P410 ... P411 (min - max)	±200%	32767	INT	4000 _{hex} 16384 _{dez}	C000 _{hex} .16385 _{dez}	4000 _{hex} * f _{setpoint} [Hz]/P411	P105
Frequency subtraction {05}	0-10V (10V=100%)	P410 ... P411 (min - max)	±200%	32767	INT	4000 _{hex} 16384 _{dez}	C000 _{hex} .16385 _{dez}	4000 _{hex} * f _{setpoint} [Hz]/P411	P105
Max. frequency {07}	0-10V (10V=100%)	P411	±200%	32767	INT	4000 _{hex} 16384 _{dez}	C000 _{hex} .16385 _{dez}	4000 _{hex} * f _{soil} [Hz]/P411	P105
Actual value Process controller {14}	0-10V (10V=100%)	P105* U _{AIN} (V)/10V	±100%	16384	INT	4000 _{hex} 16384 _{dez}	C000 _{hex} .16385 _{dez}	4000 _{hex} * f _{setpoint} [Hz]/P105	P105
Setpoint process controller {15}	0-10V (10V=100%)	P105* U _{AIN} (V)/10V	±100%	16384	INT	4000 _{hex} 16384 _{dez}	C000 _{hex} .16385 _{dez}	4000 _{hex} * f _{setpoint} [Hz]/P105	P105
Torque current limit {2}	0-10V (10V=100%)	P112* U _{AIN} (V)/10V	0-100%	16384	INT	4000 _{hex} 16384 _{dez}	/	4000 _{hex} * I[A]/P112	P112
Current limit {6}	0-10V (10V=100%)	P536* U _{AIN} (V)/10V	0-100%	16384	INT	4000 _{hex} 16384 _{dez}	/	4000 _{hex} * I[A]/P536	P536
Ramp time {49}									
Acceleration time {56}	0-10V (10V=100%)	10s* U _{AIN} (V)/10V	0...200 %	32767	INT	4000 _{hex} 16384 _{dec}	/	10s * Bus setpoint/4000hex	20s
Deceleration time {57}									
Actual values {Function}									
Actual frequency {01}	0-10V (10V=100%)	P201* U _{AOut} (V)/10V	±100%	16384	INT	4000 _{hex} 16384 _{dez}	C000 _{hex} .16385 _{dez}	4000 _{hex} * f[Hz]/P201	
Actual speed {02}	0-10V (10V=100%)	P202* U _{AOut} (V)/10V	±200%	32767	INT	4000 _{hex} 16384 _{dez}	C000 _{hex} .16385 _{dez}	4000 _{hex} * n[rpm]/P202	
Current {03}	0-10V (10V=100%)	P203* U _{AOut} (V)/10V	±200%	32767	INT	4000 _{hex} 16384 _{dez}	C000 _{hex} .16385 _{dez}	4000 _{hex} * I[A]/P203	
Torque current {04}	0-10V (10V=100%)	P112* 100/ √((P203) ² - (P209) ²)* U _{AOut} (V)/10V	±200%	32767	INT	4000 _{hex} 16384 _{dez}	C000 _{hex} .16385 _{dez}	4000 _{hex} * I _q [A]/((P112)*100/ √((P203) ² -(P209) ²)	
Master value Setpoint frequency {19} ... {24}	0-10V (10V=100%)	P105* U _{AOut} (V)/10V	±100%	16384	INT	4000 _{hex} 16384 _{dez}	C000 _{hex} .16385 _{dez}	4000 _{hex} * f[Hz]/P105	
Speed from rotary encoder {22}	/	/	±200%	32767	INT	4000 _{hex} 16384 _{dez}	C000 _{hex} .16385 _{dez}	4000 _{hex} * n[rpm]/ P201*60/Number of pairs of poles or 4000 _{hex} * n[rpm]/P202	

Table 38: Scaling of setpoints and actual values (Selection)

8.8 Definition of setpoint and actual value processing (frequencies)

The frequencies used in parameters (P502) and (P543) are processed in various ways according the following table.

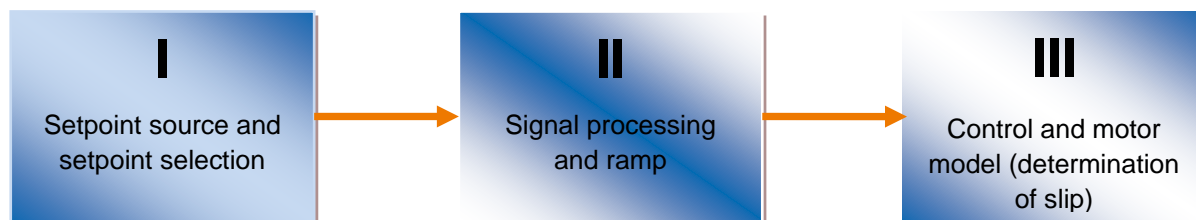

Function	Name	Meaning	Output to ...			without Right/ Left	with Slip
			I	II	III		
8	Setpoint frequency	Setpoint frequency from setpoint source	X				
1	Actual frequency	Setpoint frequency for motor model		X			
23	Actual frequency with slip	Actual frequency at motor			X		X
19	Setpoint frequency master value	Setpoint frequency from setpoint source Master value (free from enable correction)	X			X	
20	Setpoint frequency n R master value	Setpoint frequency for motor model Master value (free from enable correction)		X		X	
24	Master value of actual frequency with slip	Actual frequency at motor Master value (free from enable correction)			X	X	X
21	Actual frequency without slip master value	Actual frequency without master value slip Master value			X		

Table 39: Processing of setpoints and actual values in the frequency inverter

9 Maintenance and servicing information

9.1 Maintenance Instructions

NORD frequency converters are *maintenance free* provided that they are properly used (please see chapter 7.1 "General Data SK 500E").

Dusty environments

If the device is being used in a dusty environment, the cooling-vane surfaces should be regularly cleaned with compressed air.

Long-term storage

The device must be regularly connected to the supply network for at least 60 min.

If this is not carried out, there is a danger that the device may be destroyed.

If a device is to be stored for longer than one year, it must be recommissioned with the aid of an adjustable transformer before normal connection to the mains.

Long-term storage for 1 - 3 years

- 30 min with 25 % mains voltage
- 30 min with 50 % mains voltage
- 30 min with 75 % mains voltage
- 30 min with 100 % mains voltage

Long-term storage for >3 years or if the storage period is not known:

- 120 min with 25 % mains voltage
- 120 min with 50 % mains voltage
- 120 min with 75 % mains voltage
- 120 min with 100 % mains voltage

The device must not be subject to load during the regeneration process.

After the regeneration process, the regulations described above apply again (at least 60 min on the mains 1x per year).

Information

Control voltage with SK 5x5E

With devices of type SK 5x5E, a 24 V control voltage supply must be provided for Sizes 1 – 4 in order to make the regeneration process possible.

9.2 Service notes

Out technical support is available to reply to technical queries.

If you contact our technical support, please have the precise device type (rating plate/display), accessories and/or options, the software version used (P707) and the series number (name plate) at hand.

The device must be sent to the following address if it needs repairing:

NORD Electronic DRIVESYSTEMS GmbH

Tjüchkampstraße 37
26605 Aurich, Germany

Please remove all non-original parts from the device.

No guarantee is given for any attached parts such as power cables, switches or external displays.

Please back up the parameter settings before sending in the device.

i Information	Reason for return
<p>Please note the reason for sending in the component/device and specify a contact for any queries that we might have.</p> <p>You can obtain a return note from our web site (Link) or from our technical support.</p> <p>Unless otherwise agreed, the device is reset to the factory settings after inspection or repair.</p>	

NOTICE	Possible Consequential Damage
	<p>In order to rule out the possibility that the cause of a device fault is due to an optional module, the connected optional modules should also be returned in case of a fault.</p>

Contacts (Phone)

Technical support	During normal business hours	+49 (0) 4532-289-2125
	During normal business hours	+49 (0) 180-500-6184
Repair inquiries	During normal business hours	+49 (0) 4532-289-2115

The manual and additional information can be found on the Internet under www.nord.com.

9.3 Abbreviations

AIN	Analog input	I/O	In / Out (Input / Output)
AOUT	Analogue output	ISD	Field current (Current vector control)
BR	Braking resistor	LED	Light-emitting diode
DI (DIN)	Digital input	PMSM	Permanent Magnet Synchronous motor (permanently excited synchronous motor)
DO (DOUT)	Digital output	S	Supervisor Parameter, P003
I / O	Input /Output	SH	"Safe stop" function
EEPROM	Non-volatile memory	SW	Software version, P707
EMKF	Electromotive force (induction voltage)	TI	Technical information / Data sheet (Data sheet for NORD accessories)
EMC	Electromagnetic compatibility		
FI-(Switch)	Leakage current circuit breaker		
FI	Frequency inverter		

Key word index

2

2. encoder ratio (P463).....129

A

Absolute minimum frequency (P505)134

Acceleration time (P102).....94

Actual

cos phi (P725)154

current (P719).....153

field current (P721).....153

frequency (P716)153

Speed (P717).....153

torque current (P720).....153

voltage (P722).....153

Actual frequency processing199

Actual values198

Adaptation to IT networks.....53

Adapter cable RJ1269

Adapter module73

Additional parameters133

Address.....201

Adjustment 1 0% (P402).....115

Adjustment 1 100% (P403).....115

Adjustment 2 0% (P407)116

Adjustment 2,100% (P408).....117

Analog functions.....112, 119

Analog input filter 2 (P409)117

Analog input mode 1 (P401).....113

Analog output voltage (P710)152

Analogue inputs.....112, 119

Apparent power (P726) 154

Array parameters..... 80

Automatic error acknowledgement P506 .. 135

Automatic flux optimisation 197

Automatic flux optimisation (P219)..... 104

Automatic starting (P428)..... 125

B

Back up data record (P550) 147

Basic parameter 93

Basic parameters 87

Boost precontrol (P215) 103

Brake chopper..... 36, 148

Brake control 96, 99

Brake reaction time (P107)..... 96

Brake release time (P114) 99

Brake resistor (P556)..... 149

Brake resistor type (P557) 149

Braking distance..... 97

Braking resistor 36

Bus

Actual value 1 (P543) 145

Actual value 2 (P544) 145

Actual value 3 (P545) 145

Setpoint 1 (P546) 146

Setpoint 2 (P547) 146

Setpoint 3 (P548) 146

C

Cable duct..... 29

CAN adapter module 73

CAN bus address (P515)	137	Delivery condition.....	87
CAN bus baud rate (P514)	137	Digital analog input 1 (P400)	111
CAN master cycle (P552)	148	Digital functions.....	120, 121
CE mark.....	188	Digital input 1 (P420)	120
Choke.....	45	Digital input 2 (P421)	121
Chopper min. threshold (P554)	148	Digital input 2 function (P405).....	116
ColdPlate	31, 181	Digital input 3 (P422)	121
Commissioning	83	Digital input 4 (P423)	121
Configuration level (P744).....	157	Digital input 5 (P424)	121
Contact	201	Digital input 6 (P425)	121
Control connection.....	60	Digital input 7 (P470)	130
Control terminals.....	111	Dimensions	30, 31
Copy parameter set (P101)	93	DIP switch	62
Current		Direct current braking.....	97
DC brake (P109)	98	Disconnection mode (P108)	97
phase U (P732).....	154	Display factor (P002).....	93
phase V (P733)	154	Display selection (P001).....	92
phase W (P734).....	155	Displays and control	74
Current limit (P536).....	142	Dissipated heat	29
Current vector control.....	104	Distance calculator	97
Curve setting	102, 104	Drive profile (P551).....	147
D		DS standard motor.....	99
Danger labels.....	19	Dynamic boost (P211).....	102
Database version (P742)	156	Dynamic braking	36
DC Brake	97	E	
DC braking time On (P110).....	98	EC Declaration of Conformity	188
DC link voltage (P736)	155	Efficiency.....	29
DC run-on time (P559).....	149	Electrical data	24, 172
DC-coupling	55	EMC Directive	188
Deceleration time (P103)	94	EMC Kit	35
delay on/off switch (P475)	130	Emerg. stop on error (P427)	125

EMF voltage PMSM (P240).....	105	Fixed frequency array (P465).....	130
Emission of interference	191	Flux delay (P558).....	149
EN 55011	188	Flux feedback fact. PMSM (P333).....	111
EN 61000	191	Flying start (P520).....	138
EN 61800-3	188	Flying start offset (P522).....	139
Enable period (P715)	153	Flying start resolution (P521)	138
Encoder offset PMSM (P334)	111	Function 2 encoder (P461)	129
Encoders.....	71	Function Bus IO In Bits (P480)	131
Energy Efficiency	197	Function BusIO Out Bits (P481)	131
Environmental standard.....	188	Function encoder (P325)	109
Error messages	159	Function output 1 (P418).....	118
External heat sink technology	32	G	
F		Gateway.....	82
Factor I^2t -Motor	141	H	
Factory setting (P523)	139	Heat dissipation	29
Faults	159	Heat sink temperature (P739)	155
Features.....	10	HTL encoder.....	72, 124, 129
FI circuit breaker.....	197	Hyst. BusIO Out Bits (P483)	132
Field (P730).....	154	Hyst. Switchover PMSM (P331)	111
Field current controller I (P316)	108	I	
Field current controller P (P315)	108	Immunity from interference.....	191
Field weakening controller I (P319).....	109	Incremental encoder	72
Field weakening controller P (P318)	109	Incremental encoder (P301).....	107
Field weakening limit (P320)	109	Inductivity PMSM (P241)	105
Filter analog input 1 (P404)	116	Information.....	150
Fixed frequencies mode (P464).....	129	Input choke	46
Fixed frequency 1 (P429).....	125	Input monitoring.....	143
Fixed frequency 2 (P430).....	125	Input voltage (P728)	154
Fixed frequency 3 (P431).....	126	Installation	29
Fixed frequency 4 (P432).....	126	Installation altitude.....	168
Fixed frequency 5 (P433).....	126	Installation notes	18
		Internet.....	201

Inverter name (P501)	133	delay (P528)	140
Inverter type (P743)	156	Load monitoring mode (P529).....	140
Inverter voltage range (P747)	157	Long-term storage	168
ISD control	104	Low Voltage Directive	2
IT network	53	M	
J		Mains choke.....	45, 46
Jog frequency (P113).....	99	Mains voltage monitoring.....	143
K		Mains voltage monitoring (P538)	143
KTY84.....	88	Maintenance.....	200
L		Mass Inertia PMSM (P246)	106
Last current error (P703).....	150	Master - Slave	133
Last fault (P701).....	150	Master function	133
Last frequency error (P702)	150	Master function output (P503).....	133
Leakage current.....	53	Master function value (P502)	133
LEDs	159	Maximum frequency (P105)	95
Lifting equipment with brake	96	Maximum frequency auxiliary setpoint (P411)	
Limit		117
Field current controller (P317)	108	Mechanical power (P727).....	154
Torque current controller (P314)	108	Menu group	90
Linear V/f characteristic curve	104	Messages	159
Link circuit choke.....	45	Min.freq. process cont. (P466)	130
Link circuit last error (P705)	151	Minimal configuration	87
Load drop	96	Minimum frequency (P104).....	94
Load factory setting.....	139	Minimum frequency auxiliary setpoint (P410)	
Load monitoring	132, 141	117
Load monitoring		Modbus RTU	135
Maximum (P525)	139	Modbus RTU	10
Load monitoring		Mode analog in. 2 (P406).....	116
Minimum (P526)	139	Modulation depth (P218)	103
Load monitoring		Module status(P746)	157
frequency (P527)	140	Module version (P745)	157
Load monitoring		Motor	

cos phi (P206)	101	P	
Nominal current (P203)	101	P chopper limit (P555)	148
Nominal frequency (P201)	100	P factor torque limit (P111)	98
Nominal power (P205)	101	P set last error (P706)	151
Nominal speed (P202)	100	Parameter identification	105
Nominal voltage (P204)	101	Parameter identification (P220)	105
Star Delta connection (P207)	101	Parameter set (P100)	93
Motor cable	47	Parameter set (P731)	154
Motor cable length	50	Parameter, saving mode (P560)	149
Motor choke	47	Parameterisation	90
Motor data	83, 99	Peak current PMSM (P244)	106
Motor I ² t (P535)	142	PI- process controller	186
Motor list (P200)	99	PID control D-component (P415)	118
Motor temperature	88	PID control I-component (P414)	117
N		PID control P-component (P413)	117
No load current (P209)	102	POCON	149
Nom. val. process ctrl. (P412)	117	PotentiometerBox	81, 147
Norm. BusIO Out Bits (P482)	132	PotentiometerBox function (P549)	147
O		Power limitation	193
Offset analog output 1 (P417)	118	PPO type (P507)	135
Op.-time last error (P799)	158	Present	
Operating display (P000)	92	fault (P700)	150
Operating displays	92	operating status (P700)	150
Operating status	159	Setpoint frequency (P718)	153
Operating time	153	warning (P700)	150
Operating time (P714)	153	Process controller	112, 130, 186
Oscillation damping (P217)	103	Process data Bus In (P740)	156
Oscillation damping PMSM (P245)	106	Process data Bus Out (P741)	156
Output choke	47	Product standard	188
Output monitoring (P539)	143	Profibus address (P508)	135
Overvoltage switch-off	36	Pulse disconnection	142, 143

Pulse disconnection (P537)	143	Repairs	201
Pulse frequency (P504).....	134	RJ12 / RJ45	69
Pulse number	71	Rotary encoder connection	71
Pulse number 2 Rotary encoder (P462)	129	Rotation direction	144
Q		Rotation direction mode (P540)	144
Quick guide	87	S	
Quick stop time (P426)	125	Safety information	2, 18
R		Scaling of analog output 1 (P419)	120
Ramp smoothing (P106)	95	Service.....	201
Ramp time PI setpoint (P416)	118	Servo mode (P300)	107
Ratio encoder (P326).....	109	Set analog output (P542)	145
Reason FI disabled (P700)	150	Set Relays (P541)	144
Reduced output power	193	Setpoint frequency processing	199
Regulation PMSM (P330)	110	Setpoint processing	184
Relay 1		Setpoint source (P510)	136
function (P434)	126	Setpoints	198
hysteresis (P436).....	127	SimpleBox	78
Scaling (P435).....	127	SK BR2- / SK BR4-	37
Relay 2		SK CI1-	46
function (P441)	127	SK CO1-	47
hysteresis (P443).....	128	SK CSX-0	78
Scaling (P442).....	127	SK DCL-	45
Relay 3		SK EMC 2-.....	35
function (P450)	128	SK TU3-POT	81
Hyst. (P452).....	128	Skip frequency 1 (P516)	137
Scaling (P451).....	128	Skip frequency 2 (P518)	138
Relay 4		Skip frequency area 1 (P517).....	137
function (P455)	128	Skip frequency area 2 (P519).....	138
Hyst. (P457).....	128	Slip compensation (P212)	102
Scaling (P456).....	128	Software version (P707)	151
Reluctance angle IPMSM (P243)	106	Source control word (P509).....	135
Remote control.....	122		

Speed.....	155	T	
Speed controller I (P311).....	108	Technical data.....	168
Speed controller P (P310).....	107	Technology unit	74
Speed ctr. I brake release time (P321)	109	Telegram time out (P513).....	136
Speed encoder (P735)	155	Temperature switch.....	36
Speed slip delay (P328)	110	Temperature, Motor.....	88
Speed slip error (P327)	110	Time boost precontrol (P216).....	103
<u>Standard version</u>	13	Torque (P729)	154
Standardisation of setpoint / target values	198	Torque current controller I (P313).....	108
State of digital in. (P708)	152	Torque current controller P (P312)	108
State of relays (P711)	152	Torque current limit (P112)	98
Static boost (P210)	102	Torque disconn. limit (P534)	142
Statistic		Torque precontrol (P214)	102
Mains failure (P752).....	158	Total currents.....	60
Overcurrent (P750)	158	TTL encoders.....	65, 72
Overvoltage (P751)	158	Type code.....	27, 28
Statistics		Type plate	83
Customer error (P757).....	158	U	
Overheating (P753).....	158	UL/cUL Approval.....	172
Parameter loss (P754).....	158	Usage rate brakeres. (P737)	155
System faults (P755)	158	Usage rate Motor (P738)	155
Time out (P756)	158	USS address (P512)	136
Stator resistance (P208)	101	USS baud rate (P511).....	136
Status CANopen (P748)	157	V	
Storage	168, 200	Var. ISD control (P213)	102
Supervisor code (P003)	93	Vector control.....	104
Support.....	201	Ventilation	29
Switch over freq. PMSM (P331)	110	Voltage analog input 1 (P709)	152
switch-on cycles	168	Voltage analog input 2 (P712)	152
Switchover freq.VFC PMSM (P247)	106	Voltage –d (P723)	153
System bus tunnelling	82	Voltage last error (P704).....	151
		Voltage –q (P724)	153

W	Watchdog.....	128	
WAGO adapter module	73	Watchdog time (P460).....	128
Warning messages	150, 165	Wiring guidelines	52
Warnings	150, 159, 165		



NORD DRIVESYSTEMS Group

Headquarters and Technology Center
in Bargteheide close to Hamburg, Germany

Innovative drive solutions
for more than 100 branches of industries

Mechanical products
Parallel shaft-, helical gear-, bevel gear- and worm gear units

Electrical products
IE2/IE3/IE4-Motors

Electronic products
Centralized and decentralized frequency inverters
and motor starters

7 state-of-the-art production plants
for all drive components

Subsidiaries in 36 countries on 5 continents
providing local stock, assembly, production,
technical support and customer service.

More than 3,200 employees around the world
providing application-specific solutions for our customers.

www.nord.com/locator

Headquarters:

Getriebebau NORD GmbH & Co. KG

Getriebebau-Nord-Straße 1
22941 Bargteheide, Germany

Fon +49 (0) 4532 / 289-0

Fax +49 (0) 4532 / 289-2253

info@nord.com, www.nord.com

Member of the NORD DRIVESYSTEMS Group

