

Motors & brakemotors

High performance, 4-pole, 50 & 60 Hz

63-250 frame motors and brakemotors

order preassembled or customized to your requirements



Motors & brakes



Voltages

- ▶ 230/460V; 60 Hz
- ▶ 575V; 60 Hz
- ▶ 400V (380-415); 50 Hz

Flexible Mounting Solutions

- ▶ NEMA footed motors
- ▶ NEMA C-face flange
- ▶ IEC Footed
- ▶ IEC B14 face flange metric
- ▶ IEC B5 flange metric
- ▶ Paired with a NORD high performance speed reducer



NEMA Design & Performance

- ▶ High starting torque
- ▶ High dynamic running torque
- ▶ High breakdown torque

Inverter/Vector Duty

- ▶ Conforms to NEMA MG-1 Section 31.4.4.2
- ▶ 5:1 constant torque 60-12Hz
- ▶ 10:1 constant torque 60-6Hz
- ▶ 1000+:1 constant torque 60-0Hz with blower fan

International Certifications

- ▶  File numbers E19150, E 93429
- ▶  File number 189340-1293961
- ▶ European  rating conformance
- ▶ Motors meet global efficiency requirements

Protection From the Environment

- ▶ Sealed construction IP55 protection rating (minimum)
- ▶ Totally Enclosed Fan Cooled (TEFC)
- ▶ High Performance / Dynamic Motors
- ▶ Low Rotating Inertia
- ▶ High cycle rates
- ▶ Faster starts and stops
- ▶ More torque to start the load package

Motor Type	P _n Full Load Power		n _n Full-Load Speed	I _n Full-Load Current			I _s /I _n Locked Rotor Current Ratio	NEMA Code Letter	T _n Full-Load Torque	T _s /T _n Locked Rotor Torque Ratio	T _b /T _n Break Down Torque Ratio	pf Power Factor	η Full Load Efficiency	J _m Rotor Inertia	Duty Cycle
	[hp]	[kW]	[rpm]	230V [A]	460V [A]	575V [A]	[%]		[lb-in]	[%]	[lb-ft ²]				
Standard Efficient Motors															
63 S/4	0.16	0.12	1700	0.88	0.44	0.37	250%	F	5.93	2.7	3.5	0.66	52.0%	0.0050	S1 cont
63 L/4	0.25	0.18	1680	1.12	0.56	0.46	270%	E	9.38	2.3	2.5	0.71	57.0%	0.0066	S1 cont.
71 S/4	0.33	0.25	1710	1.56	0.78	0.66	310%	G	12.2	2.4	2.7	0.64	63.0%	0.017	S1 cont.
71 L/4	0.5	0.37	1720	1.90	0.95	0.80	350%	F	18.3	2.3	2.7	0.69	71.0%	0.020	S1 cont.
80 S/4	0.75	0.55	1710	2.70	1.35	1.12	350%	F	27.6	2.2	2.3	0.71	72.0%	0.026	S1 cont.
80 L/4	1	0.75	1650	3.66	1.83	1.46	390%	G	38.2	2.2	2.3	0.74	70.0%	0.034	60 min
90 S/4	1.5	1.1	1660	4.84	2.42	1.94	490%	G	57.0	2.5	2.8	0.78	73.0%	0.056	60 min
90 L/4	2	1.5	1660	6.34	3.17	2.54	510%	H	75.9	2.5	2.8	0.80	74.0%	0.074	60 min
100 L/4*	3	2.2	1745	8.40	4.20	3.35	610%	H	108	1.6	2.9	0.78	81.5%	0.107	60 min
100 LA/4*	4	3	1750	11.40	5.70	4.55	640%	J	144	1.8	2.8	0.78	84.5%	0.149	60 min
132 S/4	7.5	5.5	1735	19.8	9.90	7.92	540%	G	272	2.4	2.7	0.82	85.0%	0.570	60 min
132 M/4	10	7.5	1735	25.8	12.9	10.3	630%	H	363	2.9	3.2	0.84	87.0%	0.759	60 min
160 M/4	15	11	1770	35.8	17.9	14.5	820%	J	534	2.9	3.8	0.85	90.7%	1.19	60 min
160 L/4	20	15	1760	48.4	24.2	19.3	850%	K	716	2.9	3.9	0.87	89.4%	1.59	60 min
180 MX/4	25	18.5	1760	59.0	29.5	23.6	880%	K	895	3.4	4.3	0.87	90.5%	1.90	60 min
180 LX/4	30	22	1765	74.4	37.2	29.8	890%	K	1071	3.6	4.4	0.80	92.8%	2.18	60 min
200 LX/4	40	30	1770	98.6	49.3	39.4	690%	H	1424	3.2	3.6	0.83	92.1%	3.80	60 min
Premium Efficient Motors															
63 SP/4	0.16	0.12	1695	0.72	0.36	0.29	400%	D	5.95	3.4	3.3	0.62	68.5%	0.0057	S1 cont.
63 LP/4	0.25	0.18	1705	1.08	0.54	0.43	430%	D	9.24	4.1	3.9	0.57	72.5%	0.0078	S1 cont.
71 SP/4	0.33	0.25	1725	1.26	0.63	0.50	590%	F	12.1	3.7	3.9	0.67	75.8%	0.0204	S1 cont.
71 LP/4	0.5	0.37	1725	1.62	0.81	0.65	610%	E	18.3	3.3	3.6	0.72	78.0%	0.0261	S1 cont.
80 SP/4	0.75	0.55	1735	2.30	1.15	0.92	610%	D	27.2	3.4	6.1	0.72	82.7%	0.0344	S1 cont.
80 LP/4	1	0.75	1730	3.14	1.57	1.26	650%	K	36.4	3.5	3.8	0.70	86.1%	0.045	S1 cont.
90 SP/4	1.5	1.1	1740	4.20	2.10	1.68	840%	L	54.3	4.2	4.9	0.76	86.9%	0.081	S1 cont.
90 LP/4	2	1.5	1730	5.60	2.80	2.24	760%	K	72.9	3.9	4.3	0.78	87.0%	0.093	S1 cont.
100 LP/4**	3	2.2	1765	8.21	4.11	3.28	960%	M	107	3.7	4.9	0.75	90.3%	0.176	S1 cont.
100 AP/4**	4	3	1760	10.9	5.43	4.34	875%	L	143	3.6	4.5	0.79	90.3%	0.204	S1 cont.
112 MP/4	5	3.7	1755	13.0	6.50	5.20	950%	L	180	4.1	4.6	0.80	90.3%	0.332	S1 cont.
132 SP/4	7.5	5.5	1770	19.5	9.75	7.80	1020%	M	267	4.7	5.0	0.77	91.7%	0.759	S1 cont.
132 MP/4	10	7.5	1765	26.7	13.4	10.7	960%	M	357	4.7	5.0	0.77	91.7%	0.831	S1 cont.
160 MP/4	15	11	1770	35.6	17.8	14.2	880%	K	534	3.2	3.8	0.84	92.5%	1.59	S1 cont.
160 LP/4	20	15	1775	47.6	23.8	19.0	1080%	M	710	4.3	4.7	0.85	93.0%	2.18	S1 cont.
180 MP/4	25	18.5	1780	60.6	30.3	24.2	1010%	L	885	3.9	4.0	0.82	93.6%	3.80	S1 cont.
180 LP/4	30	22	1780	69.6	34.8	27.8	880%	K	1062	3.3	3.4	0.85	93.6%	3.80	S1 cont.
225 RP/4	40	30	1785	-	49.5	39.6	890%	K	1420	3.4	3.8	0.81	94.5%	11.63	S1 cont.
225 SP/4	50	37	1785	-	59.7	47.8	880%	K	1752	3.0	3.7	0.82	94.6%	12.81	S1 cont.
225 MP/4	60	45	1785	-	72.0	57.6	910%	K	2131	3.3	3.6	0.83	95.2%	15.90	S1 cont.
250 WP/4	75	55	1785	-	84.4	67.5	920%	J	2604	2.9	3.2	0.86	95.4%	19.46	S1 cont.

* Series ASAB

** Series APAB

With energy efficient gearing, inverter-duty motors, and AC variable frequency drives, NORD provides an intelligent energy saving product portfolio. NORD can be your partner in selecting motors to match each application for ideal performance and maximum energy savings. In keeping with this concept, NORD offers a variety of high performance motors including:

- ▶ NORD continuous duty, premium efficient motors (0.16 – 75 HP) satisfy global energy efficiency mandates. NORD's premium efficient motors provide maximum energy savings, offer low rotor inertia, provide quick starts & stops, & handle high cycle rates in dynamic applications.
- ▶ NORD 60 minute duty motors (1 – 40 HP) motors are labeled "60 MIN" duty & are perfectly suited for intermittent or time limited applications. These motors offer higher cycling capacity, lower motor rotor inertia, & lower energy consumption while starting or stopping, as compared to the NORD Premium Efficient motors. NORD can also provide motors that satisfy other periodic duty or intermittent duty ratings.
- ▶ NORD continuous duty, standard efficient motors (0.16 – 0.75 HP) satisfy global energy efficiency mandates. They are exempt from the June 1, 2016 mandate requiring NEMA Premium Efficiency Levels (D.O.E. 10 CFR Part 431). Like 60 minute duty motors, these motors offer higher cycling capacity, lower motor rotor inertia, and lower energy consumption while starting or stopping, as compared to the NORD Premium Efficient motors.

Effective June 1, 2016, most general purpose, 1- 500 HP, continuous duty motors sold in the U.S., must meet NEMA Premium Efficiency Levels (D.O.E. 10 CFR Part 431). Intermittent-rated motors (60 Min. Duty) and fractional horsepower/totally-enclosed motors are exempt from this latest U.S. efficiency mandate; properly applied, these motors often lead to less energy consumption, especially during starts and stops.

Motor design

INVERTER DUTY MOTOR

Inverter duty winding protection, Class H magnet wire insulation, double coated wire, and voltage spike protection.

End bell to stator connections are sealed to keep out moisture.

Shaft lip seal prevents contaminants from entering.

Bearing grease has superior resistance to washout, rust and corrosion.

Corrosion-resistant, non-sparking fan.

Die cast aluminum rotor coated to prevent corrosion.

Corrosion-resistant aluminum alloy construction.

Threaded cable entry allows the power feed line to be sealed.

Shaft lip seal excludes speed reducer lubricant, allowing motor to be mounted in any position.

Standard paint has 316 stainless steel flakes with a flexible and tough resin binder. USDA incidental contact H1 approval provides excellent moisture resistance.

Conduit box connections and lid have gaskets to ensure a watertight seal.

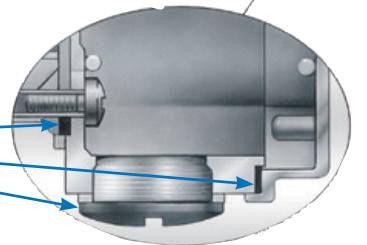
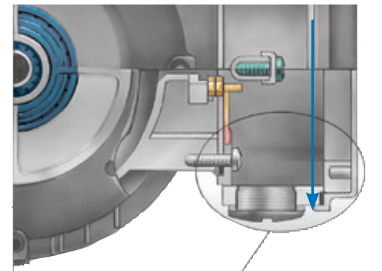
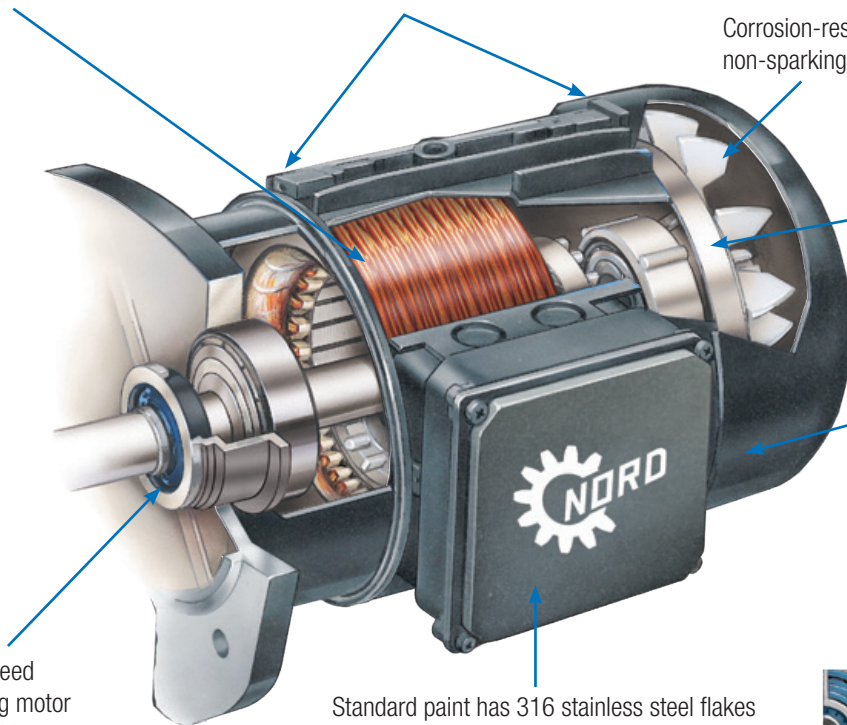
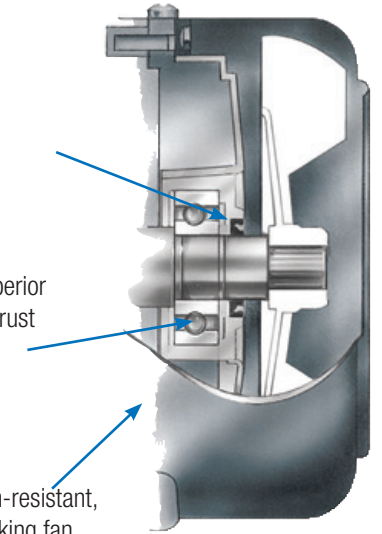

Designed For Inverter/Vector Duty

- ▶ Class H magnet wire insulation is double coated for extra protection
- ▶ Magnet wire slots are lined with insulation to prevent chafing
- ▶ First turn winding construction handles line surges
- ▶ Varnish dipped stator gives added moisture protection
- ▶ 1.15 Service Factor
- ▶ Class B temperature rise
- ▶ Voltage spike resistance per NEMA MG-1 1998 Section 31.4.4.2
- ▶ Phase paper & Sleeved connecting leads

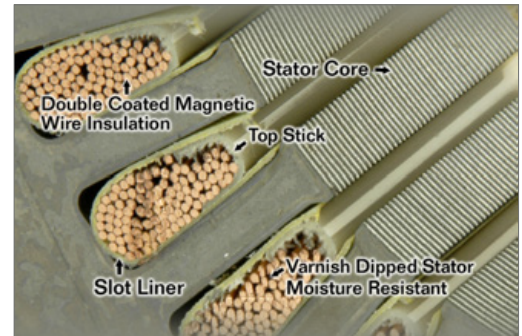

Designed For High Start/Stop Cycle Rates

- ▶ Low rotating inertia
- ▶ Rapid acceleration/deceleration
- ▶ Reversible rotation
- ▶ Finned aluminum alloy stator housing
- ▶ Low temperature rise
- ▶ Across the line or inverter operation
- ▶ Up to 8600 starts per hour

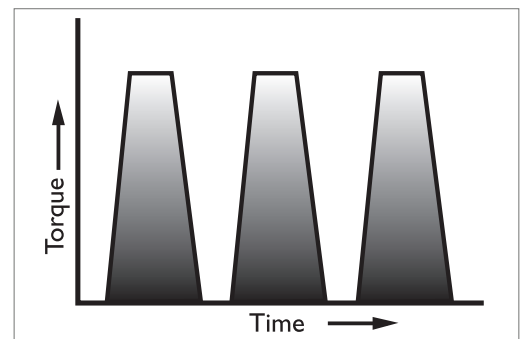

Designed For High Performance Braking

- ▶ Faster release
- ▶ Quicker stopping
- ▶ Multiple brake sizes available
- ▶ Brake voltage options
- ▶ No external wires for standard brake
- ▶ AC or DC switching
- ▶ Adjustable torque



Designed For Protection From The Elements

- ▶ Corrosion resistant aluminum alloy housing
- ▶ Shaft lip seals exclude contaminants from both ends
- ▶ Inorganic fungus protection
- ▶ Sealed end bell connections
- ▶ Bearing grease resists moisture
- ▶ Moisture resistant internal materials
- ▶ Gasketed and sealed terminal box
- ▶ Terminal block connector organizes power feed
- ▶ Cast metal terminal box for connection rigidity



Motor options



Power Off Brakes (BRE)

- ▶ Deliver torque when power is off
- ▶ Ready-to-go wired by factory
- ▶ Long life
- ▶ Rapid cycling
- ▶ Adjustable torque
- ▶ Simple mechanical construction



Brake Options

- ▶ Hand release lever (HL)
- ▶ Lockable hand lever (FHL)
- ▶ Current sensing relay (IR)
- ▶ Fast release rectifier (GP)
- ▶ Corrosion protection (RG)
- ▶ Severe duty protection (NSD+)
- ▶ Working brake or holding brake



Incremental Encoder (IG...)

- ▶ Feedback speed/position control
- ▶ Pulse count from 100-5000
- ▶ Operating voltages from 4-6 or 10-30VDC
- ▶ Interface either RS422/TTL or HTL/push-pull type

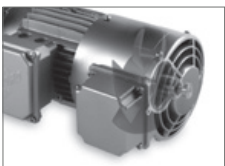

Blower Fans (F, FC)

- ▶ Independent of motor speed
- ▶ Available for line power
- ▶ Use with low motor speeds



Thermal Protection

- ▶ Thermostat bi-metallic switches (TW)
- ▶ Thermistor PTC Sensors (TF)



Double Fan Drip Cover (RDD)

- ▶ Extra protection from wind blown moisture
- ▶ Ideal option for windy outdoor duty



Canopy Drip Cover (RD)

- ▶ Use in wet vertical up installations
- ▶ Protects motor from falling water
- ▶ Provides umbrella protection for the motor



Energy Efficient Motor

- ▶ High efficiencies
- ▶ Cost Savings
- ▶ Premium Efficiency (EISA)
- ▶ International efficiency (IE1, IE3)



Severe Duty Protective Paint Coatings

- ▶ Surface coatings for a variety of environments
- ▶ USDA compliant
- ▶ Standard colors: Stainless Steel Gray and White
- ▶ Custom paint colors



IP66 Enclosure Protection

- ▶ Can handle high-pressure washdown environments



Space Heater (SH)

- ▶ Anti-condensation heater installed inside motor
- ▶ Heats up windings preventing condensation
- ▶ Available voltages



Power Plug Quick Connector

- ▶ Simple & fast power connections
- ▶ Modular plug wired - ready to go
- ▶ Allows rapid change out of motor
- ▶ Makes remote assembly easier



High Inertia Cooling Fan (Z)

- ▶ Adds inertia to motor
- ▶ Slows down motor starts/stops
- ▶ Mechanical soft start or soft stop
- ▶ Stores motor kinetic energy
- ▶ Smoothing for rapid load changes



Shaft Extension Outside Fan Cowl (WE)

- ▶ Used to mount customer-supplied devices
- ▶ Also can be power take off

NORD offers many additional options not listed here. Contact us for more information.

Inverter / Vector Duty Operation

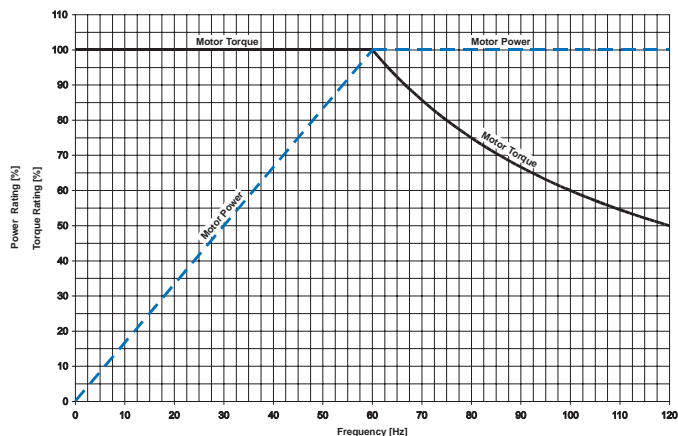

Typical Inverter/Motor Performance

Most applications for motors and variable frequency inverters require constant torque. This means that the load torque is constant and is independent of output speed. NORD motors are well equipped to handle constant torque applications. To the left is a typical operating characteristic chart for NORD motors used on constant torque inverters. This chart demonstrates the frequency range where NORD motors deliver constant torque and constant power.

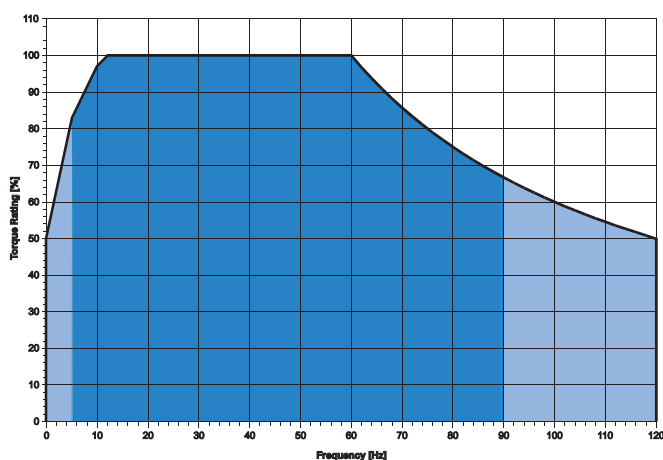

Typical TEFC Motor Performance

NORD motors are able to safely operate over a wide frequency range between 0Hz and 120Hz. The blue shaded zone below the curve on the chart indicates the safe continuous operating zone. The light blue shaded zone below 5Hz & above 90Hz indicate a cautionary performance area that may be limited by an inverter or vector controller.

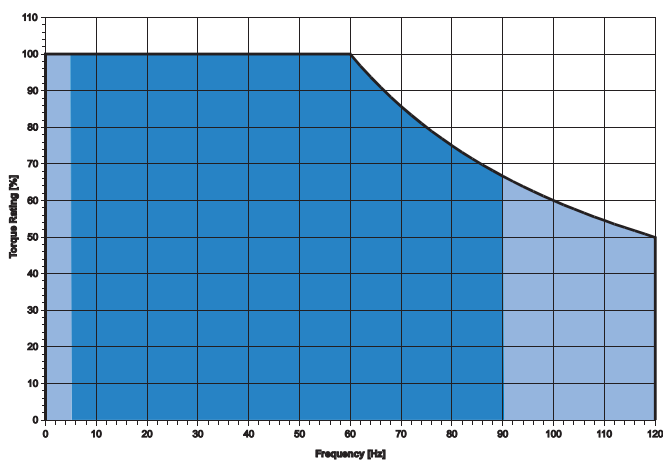

Typical TEBC Motor Performance (Blower Cooled)

NORD motors are able to safely operate over a wide frequency range between 0Hz and 120Hz. The blue shaded zone below the curve on the chart indicates the safe continuous operating zone. The light blue shaded zone below 5Hz and above 90Hz indicate a cautionary performance area that may be limited by an inverter or vector controller.

Ordering is Easy With myNORD Online Tools!

- ▶ Obtain drawing files direct from quote configuration
- ▶ Effortlessly select & configure customized drive solutions
- ▶ Create quotes with account-specific net pricing
- ▶ Order-specific documentation
- ▶ 24/7/365 order tracking
- ▶ Select and order spare parts

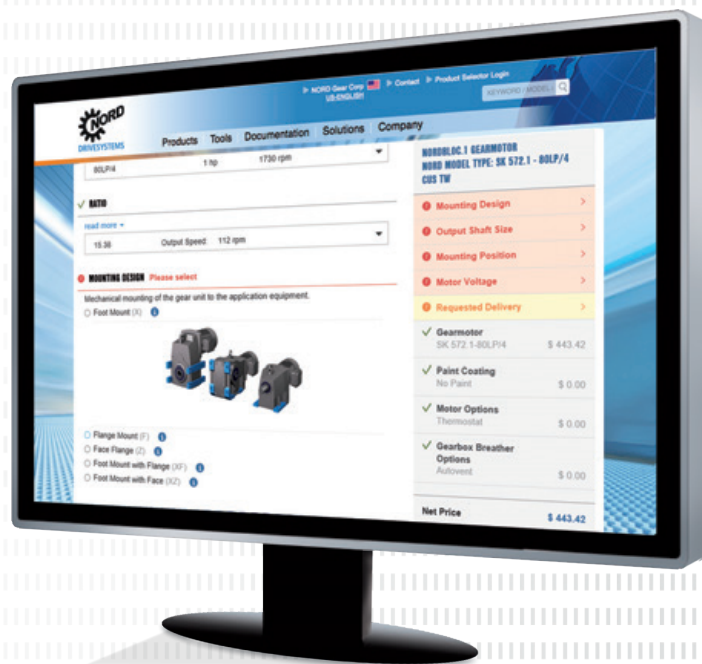

Register now at myNORD.com!



www.nord.com

NORD Gear Corporation - US

Waukegan, WI
800 NORD Drive
Waukegan, WI 53597
Tel. 888.314.6673
info.us@nord.com

Corona, CA
1180 Railroad St.
Corona, CA 92882
Tel. 888.314.6673
info.us@nord.com

Charlotte, NC
300E Forsyth Hall Dr.
Charlotte, NC 28273
Tel. 888.314.6673
info.us@nord.com

NORD Gear Limited - Canada

Brampton, ON
41 West Drive
Brampton, ON L6T4A1
Tel. 800.668.4378
info.ca@nord.com

NORD DRIVE SYSTEMS SA DE CV

Queretaro, Mexico
Av. Industria Textil B.6
Parque Industrial PYME, Huimilpan
QRO - Mexico 76950
Tel. 52 442 688 7110
info.mx@nord.com