

# Drive Solutions for the Packaging Industry

Complete drive systems from a single source



**DRIVESYSTEMS**

Our Solution. Your Success.

# Complete Drive Solutions from a Single Source



## NORD Delivers

NORD offers first-class customer service and support along with full-featured drive solutions that can tackle the toughest requirements. All components are carefully selected and precisely configured to meet your exact specifications. In the rare case that standard components won't meet your needs, our in-house engineering team will work with you to design custom components or a complete customized system.

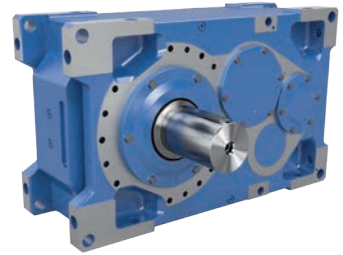

## Reduce Lead Times and Decrease Inventory

- ▶ Fastest lead times in the industry with NO expedite fees
- ▶ Over 20,000,000 standard configurations to reduce or eliminate the need for custom components
- ▶ Modular drives, motors, and electronic controls minimize inventory of replacement units and parts



## Global Product Designs, Standards, and Support

- ▶ Innovative, industry-standard products to support a wide range of applications
- ▶ Global sales and support network
- ▶ Dedicated mechanical and electrical application engineers ready to assist you
- ▶ Online resources available to you any time
- ▶ 24/7/365 emergency breakdown service



## Increase Efficiency and Reduce Operation Costs

- ▶ myNORD online tools for fast selection, configuration, ordering, and tracking of your drive units
- ▶ Drive systems that are perfectly matched to your application for optimum performance and energy efficiency
- ▶ Program personalization, such as weekly shipment schedules and custom nameplates
- ▶ Partner with a company that is easy to do business with and wants to see you succeed!



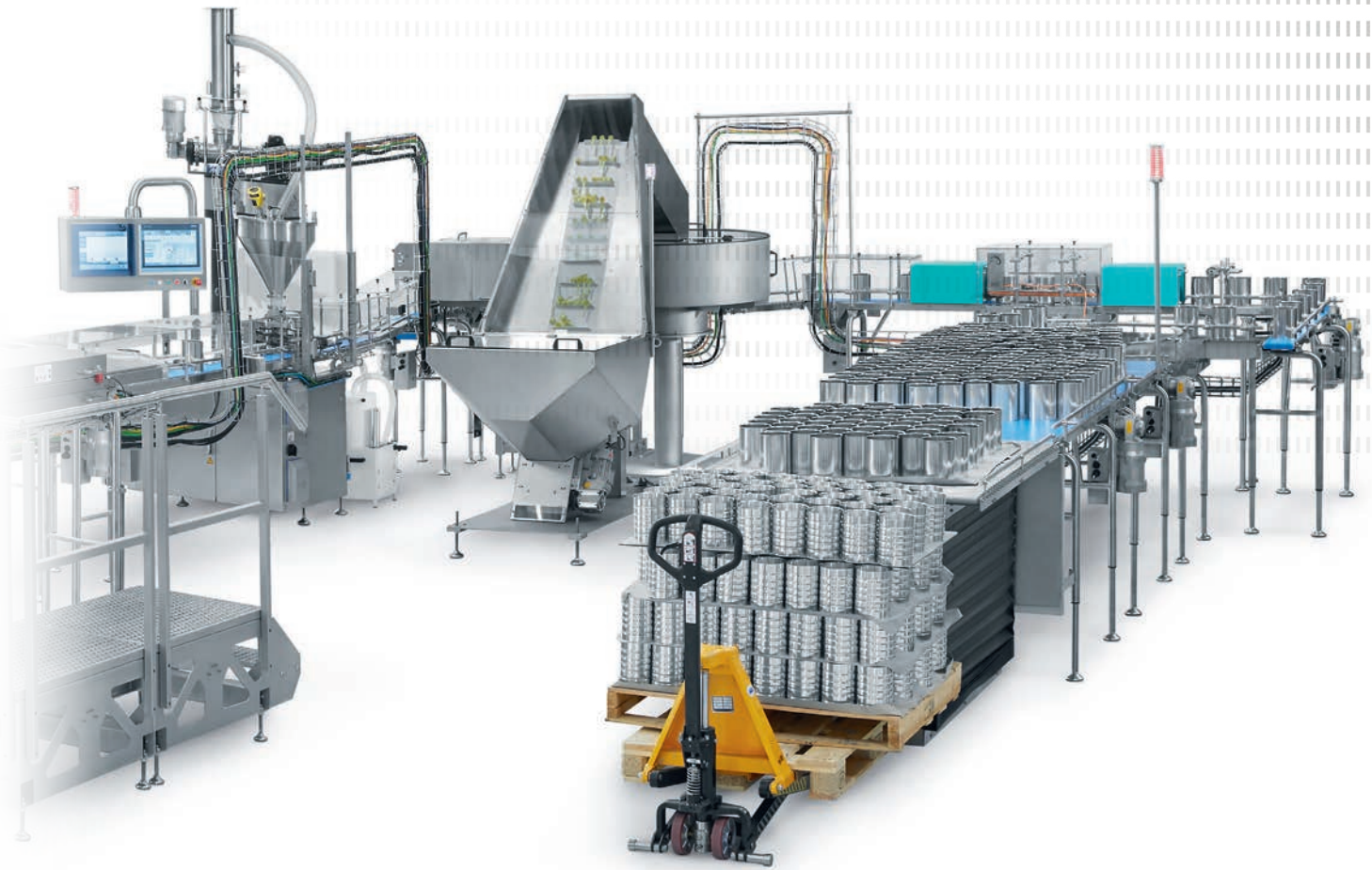

## NORD - Your Global Partner for Reliable & Versatile Solutions for Packaging Machines.

### Reliable Partner

Decades of experience configuring drives for special applications. NORD technology is made to last.

### Efficient Engineering

Straight-structured system support and decentralized, intelligent integration saves time in engineering, purchasing, installation, and operation.

### Connected

NORD drives can be directly connected to all common BUS systems and horizontally connected with decentralized solutions.

# Drive Solutions for the Packaging Industry

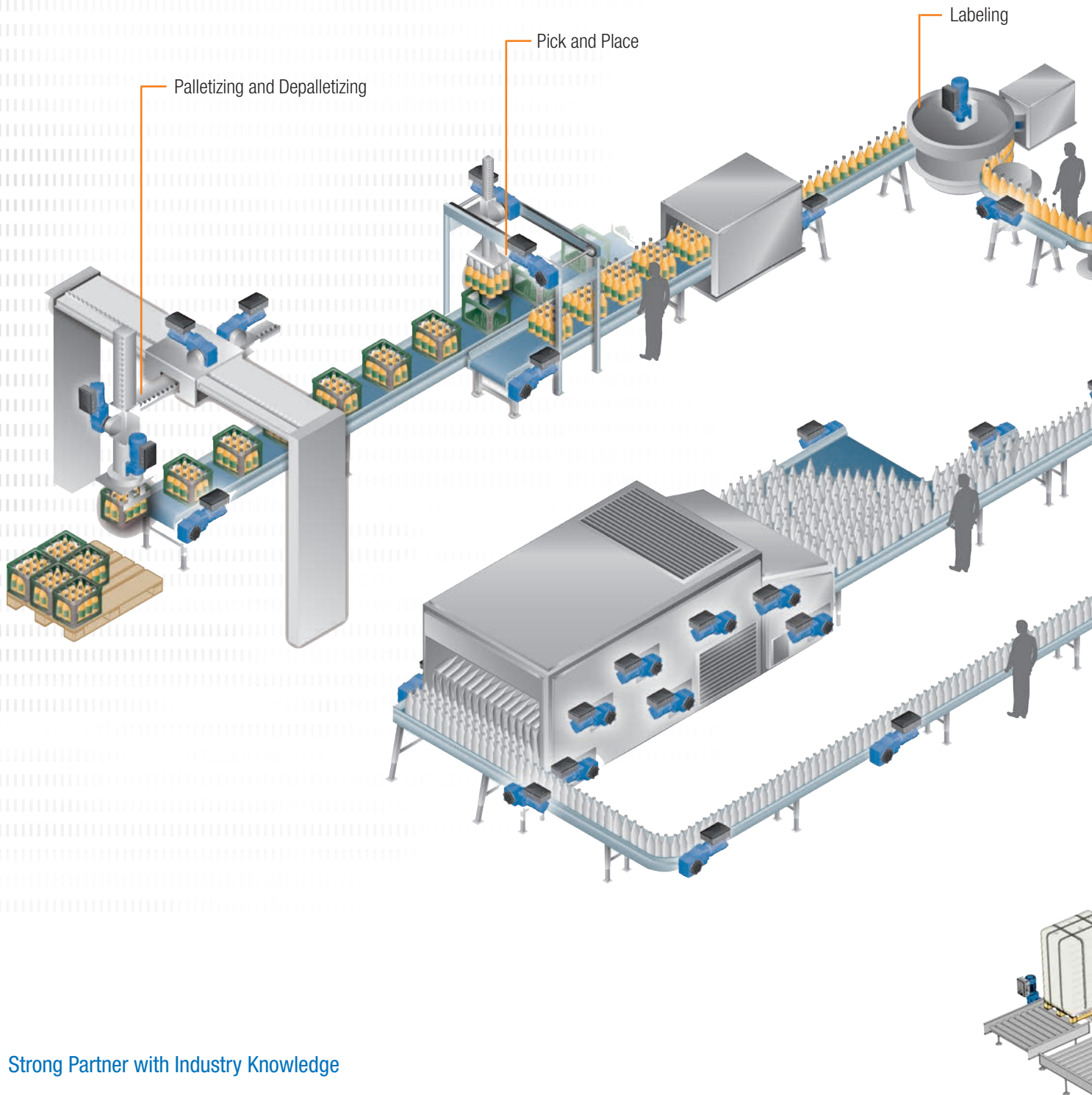

## Strong Partner with Industry Knowledge

Manufacturers and operators of packaging machines and transport systems need a strong partner with great expertise in drive technology and profound industry knowledge in the packaging industry. NORD DRIVESYSTEMS is this reliable partner with in-house engineering teams to help you find the best solution for your applications.

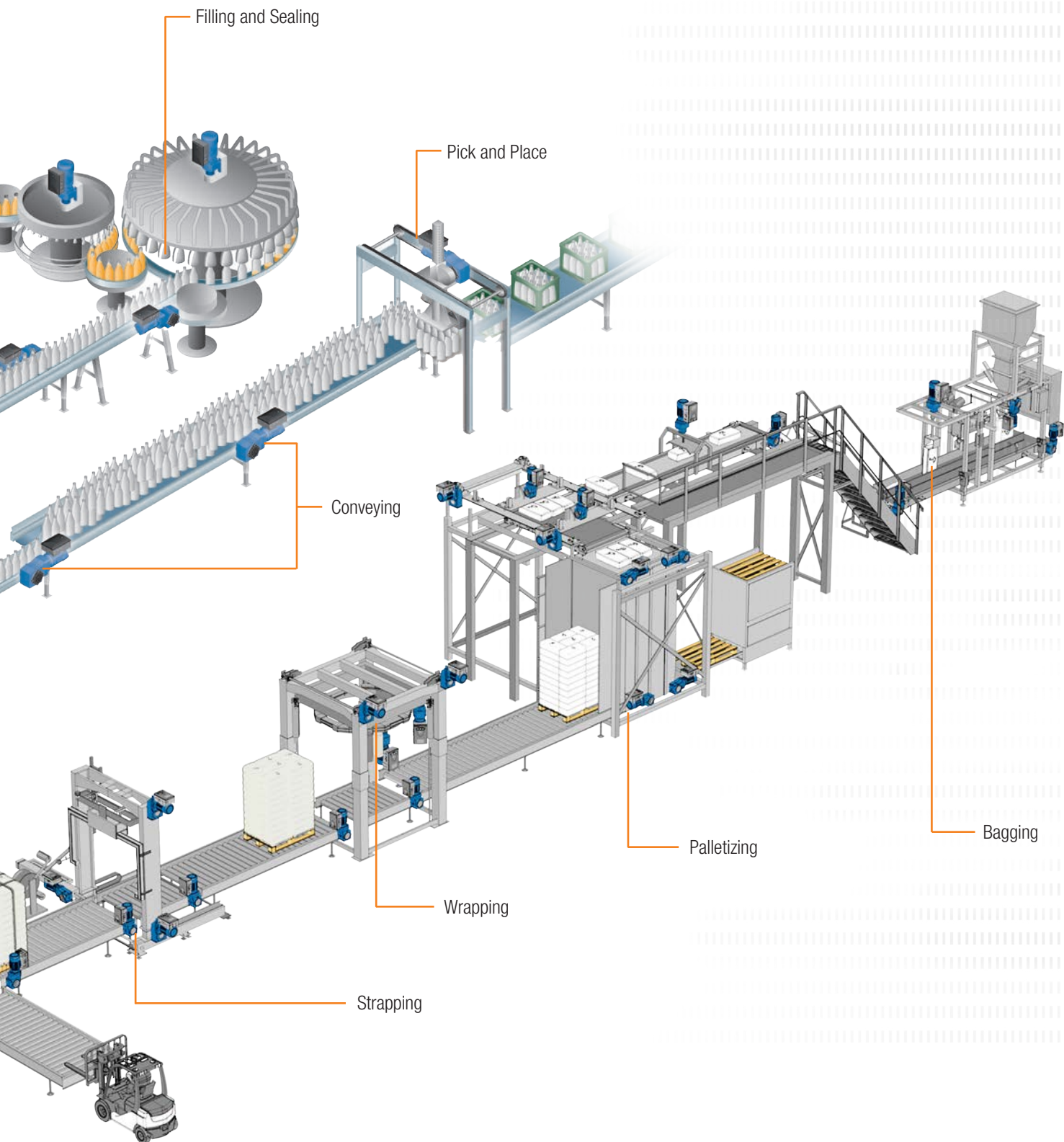

# Drive Solutions for the Packaging Industry

## From Start to Finish – NORD Moves your Packaging Machinery

Electric drives play an important role for packaging machines. They can be used to convey packaging material, drive tools, form and seal packages, and more. They are also essential for monitoring and controlling the overall packaging process.

NORD's electrical drive systems are easy to install, maintenance-friendly, energy-efficient, and can be quickly adapted to the needs of these applications. Their reliable operation ensures high efficiency and precise movements.



### Primary Packaging

In primary packaging, food, pharmaceuticals, and other hygiene-sensitive products must be handled with care. Drive systems in these applications must be easy to clean, resistant to chemical cleaning agents, and protected against potential contamination. Focus is on positioning accuracy and chemical resistance in primary packaging.

In primary packaging, we offer drive solutions for the following processes:

- ▶ Forming
- ▶ Dosing
- ▶ Filling
- ▶ Sealing



### Secondary Packaging

In comparison to pneumatic options, electrical drive systems are more efficient, have better precision and control, and allow for more energy efficiency within the system. Electric drives also have a longer service life and require less maintenance. For these applications, NORD DRIVESYSTEMS offers a wide portfolio of drive components including gear units, high-efficiency motors, and drive electronics that are perfectly matched to the requirements you specify.

In secondary packaging, we offer drive solutions for the following processes:

- ▶ Carton erecting
- ▶ Filling
- ▶ Sealing
- ▶ Foiling
- ▶ Enveloping
- ▶ Shrinking



## End-of-Line Packaging

In end-of-line packaging, heavy pallets, boxes, and containers are transported over long distances, requiring powerful, individual drive systems. NORD DRIVESYSTEMS offers drive components for all types of packaging, strapping, and palletizing machinery from a single source. Electric drives with higher rotor inertia ensure better motion control when moving heavy loads, especially with fast movements and dynamic load changes. They also enable high process stability, reduced vibrations, and decrease the risk of damaging the load or packaging machine.

In end-of-line packaging, we offer drive solutions for the following processes:

- ▶ Palletizing
- ▶ Wrapping
- ▶ Strapping



## Higher-Level Applications

Through all processing stages in the packaging industry, transportation and provisioning processes play a decisive role. Whether individual units or larger containers being transported, powerful, efficient drive systems are required and must be optimized for the respective application. With NORD's wide range of modular products, we are able to select suitable solutions that can be individually adjusted to the respective requirements.

For higher-level applications, we offer drive solutions for the following processes:

- ▶ Conveying
- ▶ Pushing
- ▶ Rotating
- ▶ Packaging handling
- ▶ Labeling

# Drive Solutions for the Packaging Industry

## Pouch Sorters

Pouch sorters are overhead conveyor systems for fully-automatic storage, buffering, transport, sorting, and commissioning of hanging and flat goods. The compact systems optimize space utilization of storage areas and enable a seamless process chain up to the packaging station. High efficiency and flexibility is achieved through NORD gear motors combined with lightweight, decentralized drives directly attached to the overhead conveyors.

### Typical Drive Specifications

- ▶ Compact design
- ▶ Service friendly
- ▶ Low maintenance
- ▶ Plug-and-Play
- ▶ Ethernet and IIoT interfaces
- ▶ Variant reduction
- ▶ Functional safety
- ▶ Global certification

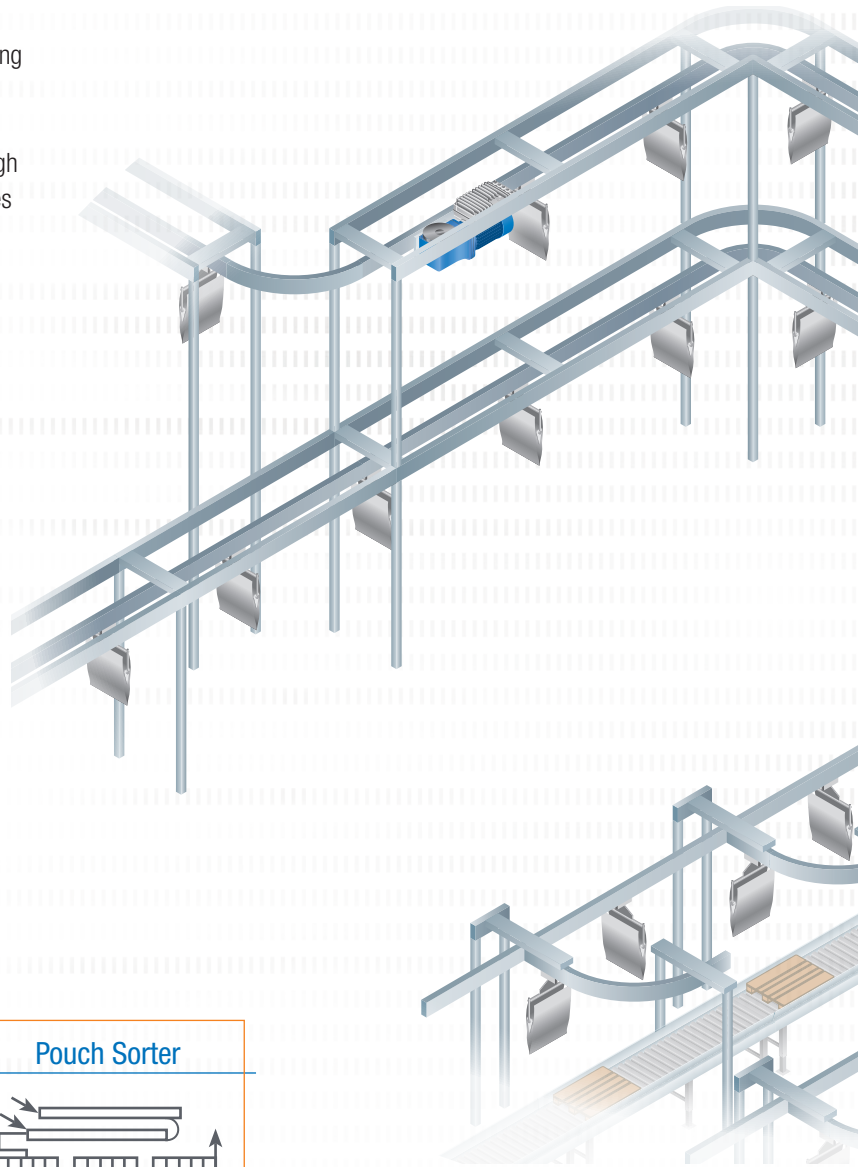

### Circular Sorter

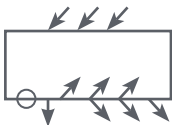

- ▶ Sorting device forms a closed loop
- ▶ Multiple entry and exit points
- ▶ Usage of different loading and unloading technologies/principles

### Linear Sorter



- ▶ Sorting device forms a single line
- ▶ One entry and multiple exit points
- ▶ Usage of one loading and unloading technology/principle

### Pouch Sorter



- ▶ Sorting device is based on pouch circulation
- ▶ Multiple entry and (typically) one exit points
- ▶ Sorter includes buffer functionality



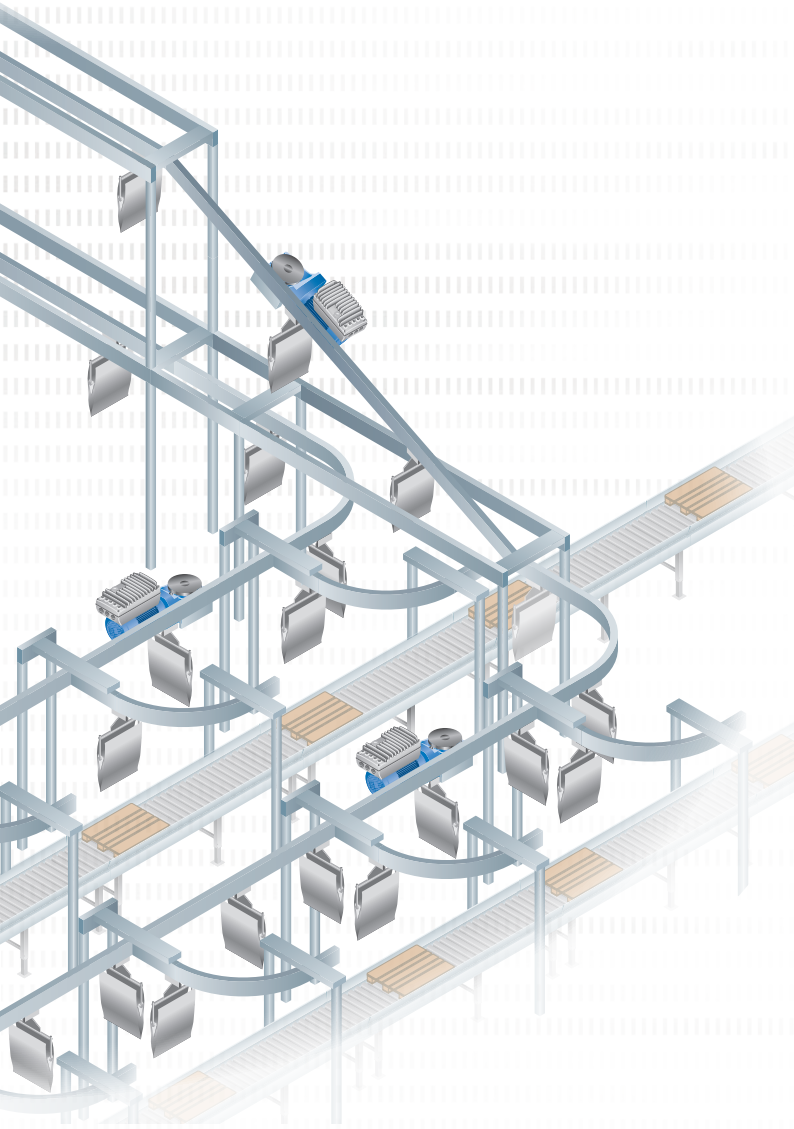

## The NORD Solution

NORD offers compact, low-maintenance drive solutions for pouch sorters that result in a minimum number of drive variants and quiet, energy-efficient operation. The standard solution for these systems is a combination of the UNIVERSAL motor, a bevel or worm gear unit, and the decentralized NORDAC *ON* variable frequency drive.

- ▶ The energy-efficient UNIVERSAL motor is certified according to CE, UL, CSA, CCC, ISI, and EAC standards and can be used worldwide. It is preferably operated at 87 Hz and is ideally suited for combination with the NORDAC *ON* thanks to its corresponding stator winding. By using a variable frequency drive, the motor can be operated on a 50 Hz / 60 Hz mains supply.
- ▶ Bevel and worm gear units are characterized by their compact design. Thanks to their optimally reinforced bearings, they are able to absorb large axial forces.
- ▶ The NORDAC *ON* variable frequency drive was designed specifically for horizontal conveyor technology. It is decentralized, compact, and plug-and-play compatible. The integrated multi-protocol Ethernet interface can reduce system variants in addition to saving space and providing cost benefits.

## Industries Utilizing Pouch Sorter Technology

### Fashion

Customers order different sizes, try them all on, choose the one that works best, and send the remaining items back. Pouch sorter systems deal with this reality. They store all goods and garments within large warehouses and run in a circular pattern. Once ordered, the goods come to the shipping area and find their way to the customer.

### General Trade

Similar to the fashion industry, however the type of goods being sorted can vary greatly.

### E-Commerce

As online shopping has matured, easy ordering and convenient delivery are expected.

# Drive Solutions for the Packaging Industry

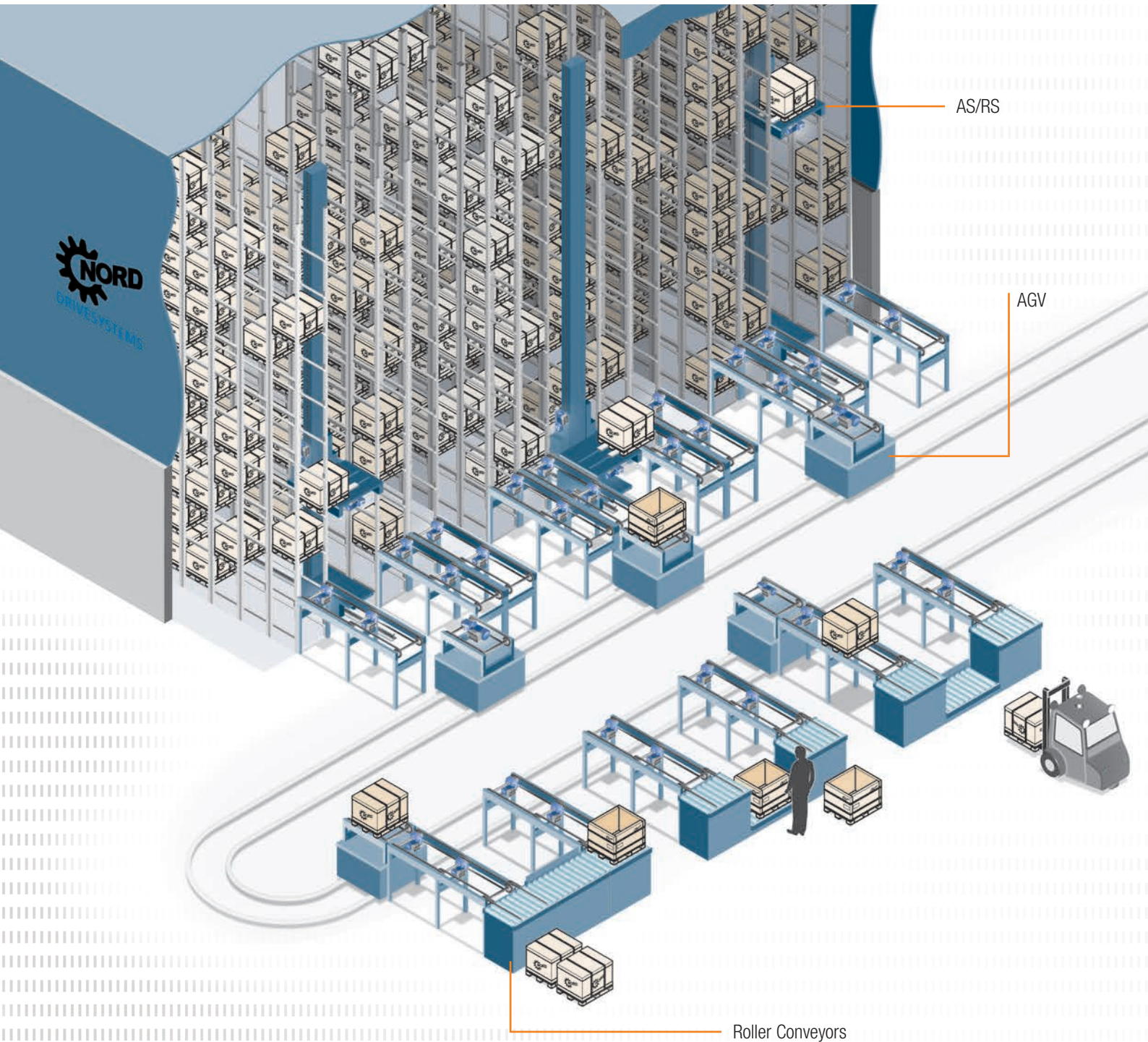

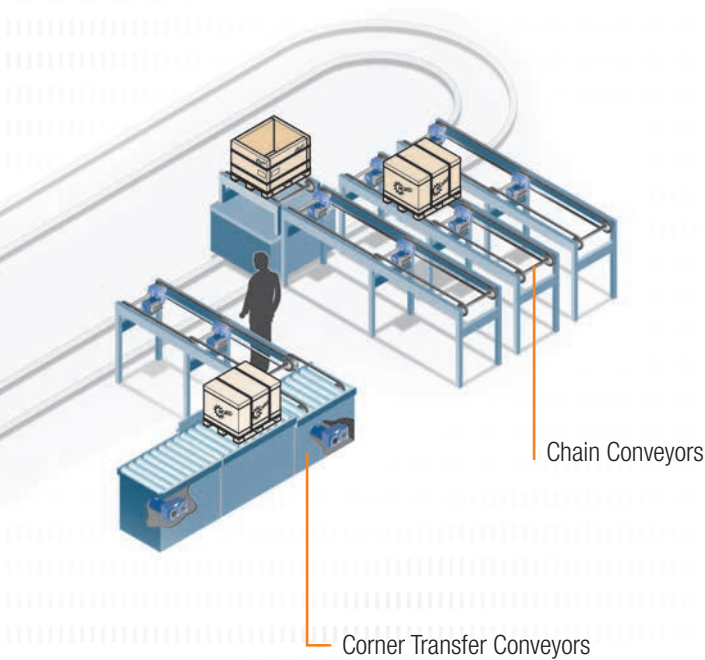

## Pallet Conveyors

Pallet conveyor technology is used to convey general goods (pallets and boxes) primarily for intralogistics transport within a company. The conveyors are typically installed permanently as an alternative to transport with industrial trucks.

Typical conveyor technology components are: chain conveyors, roller conveyors, corner transfer conveyors, turntables, transfer trolleys, lifters, palletizing and depalletizing machines, and infeed/outfeed stations.

## Typical Drive Specifications

- ▶ Compact design
- ▶ Standardization
- ▶ Brake control
- ▶ High overload capacity
- ▶ Smooth, gentle start and stop
- ▶ Decentralized VFDs (ASI bus or Ethernet)
- ▶ Service-friendly (Plug-and-Play, short replacement time)
- ▶ Global certification

## The NORD Solution

The NORD LogiDrive solution for warehouses uses a NORDAC *ON* VFD for Ethernet applications and a NORDAC *FLEX* VFD for other applications. The solution is rounded off with a high-efficiency IE3 87 Hz universal motor or an IE5+ synchronous motor. For all common gear unit types, NORD utilizes its large modular system.

# Drive Solutions for the Packaging Industry

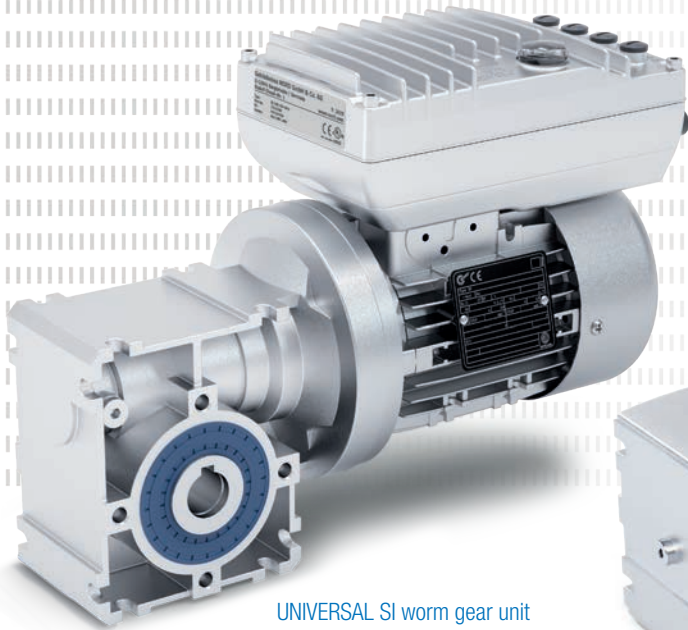

UNIVERSAL SI worm gear unit  
IE3 motor  
NORDAC ON VFD

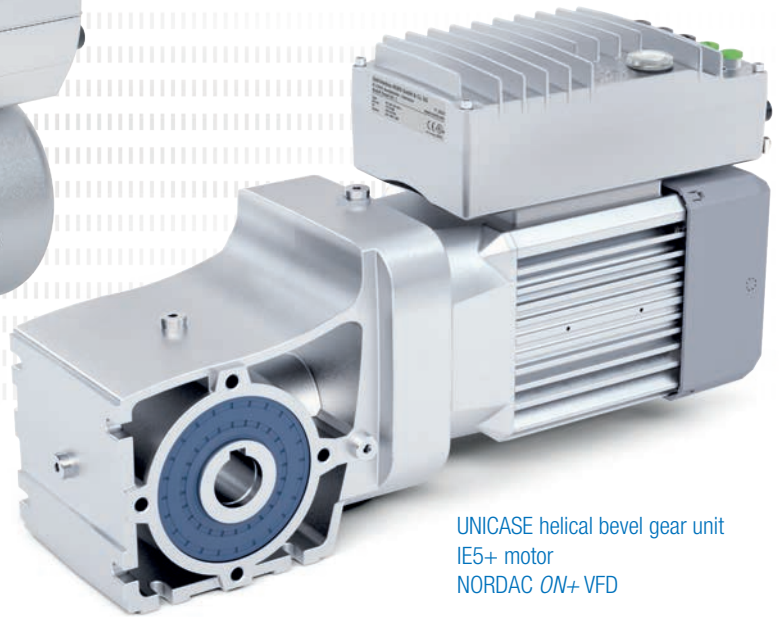

UNICASE helical bevel gear unit  
IE5+ motor  
NORDAC ON+ VFD

## NORD Motors

NORD's high-efficiency electric motors are produced in-house and offer a high degree of robustness, reliability, and flexibility. They are compatible with our full line of gear units and variable frequency drives and feature extensive configuration options including encoders, brakes, sensors, and more.

- ▶ IE3 motors from 0.16 – 75 hp (sizes 63 – 250)
- ▶ IE4 synchronous and asynchronous motors from 1.50 – 7.50 hp (Sizes 80 – 100)
- ▶ Global approvals and acceptance
- ▶ Various motor protection options
- ▶ Direct motor mounting options
- ▶ High gear ratios

## IE5+ Synchronous Motors

The new IE5+ motor generation is designed for minimizing variants and reducing operating costs using the highest operational efficiency with IE5+ technology. The motors deliver constant torque over a wide speed range and maintain consistent efficiency even at partial load and low speed ranges.

- ▶ Power range: Ventilated (TEFC): 0.50 – 5.00 hp  
Non-ventilated (TENV): 0.50 – 3.00 hp
- ▶ Reduced TCO and fast ROI
- ▶ Fully matched NORD modular system solution with gear unit, motor, and variable frequency drive
- ▶ Brake with or without hand release
- ▶ Different encoder options for closed loop
- ▶ Available with temperature sensor

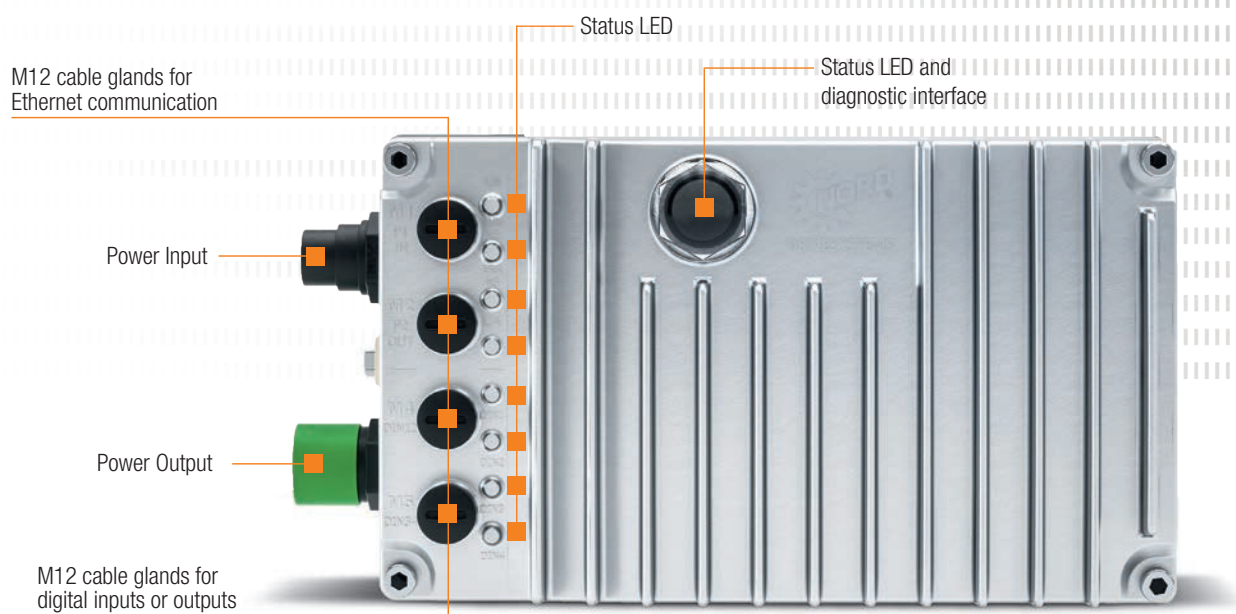

## NORDAC ON/ON+ VFDs

NORDAC *ON/ON+* decentralized variable frequency drives are designed for the special requirements and varying needs of packaging applications. The NORDAC *ON* has been developed for IE3 gearmotors while the NORDAC *ON+* has been optimized for use with IE5+ synchronous gearmotors.

- ▶ Power range: 0.50 – 4.00 hp
- ▶ Protection class: IP55, IP66
- ▶ Wall of motor mounting
- ▶ Multi-protocol Industrial Ethernet interface
- ▶ Full Plug-and-Play compatibility
- ▶ Economic solution for IIoT environments

Scan for more information:



M7000 –  
Asynchronous  
Motors



M5000 –  
IE5+ Synchronous  
Motors



E3000 –  
NORDAC Electronic  
Drive Technology

# Drive Solutions for the Packaging Industry

## Condition Monitoring for Predictive Maintenance

In condition monitoring, operating and status data are regularly or continuously recorded in order to optimize the reliability and efficiency of the plant and machinery. Important information for predictive maintenance can be derived from the data analysis.

The objective is to maintain machines and plants proactively, to reduce downtimes and to increase the efficiency of the entire plant.

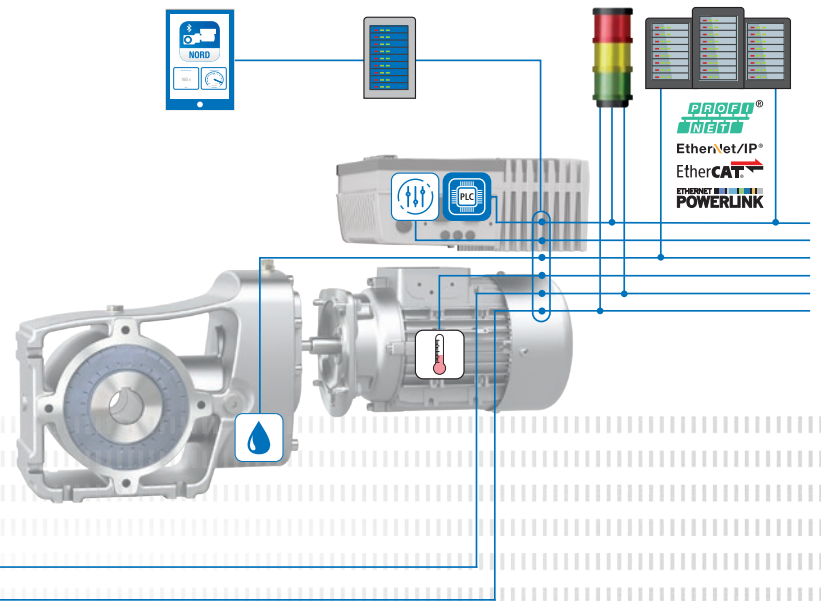

System  
vibration sensor



- ▶ NORD qualified sensors
- ▶ Connection of customized sensors (analog / digital)

System  
temperature sensor



- ▶ PT1000-based motor temperature sensor
- ▶ Ambient or system temperature

Oil change



- ▶ Determination of the optimal time for oil change on the basis of virtual oil temperature
- ▶ The algorithm is executed in the internal PLC

Drive parameters



- ▶ Readout of drive system parameters
- ▶ Basis for virtual sensors

Integrated PLC



- ▶ Pre-processing of drive-specific parameters and sensors related to the drive
- ▶ Evaluation of drive conditions

Beacon signal



- ▶ Local display of drive conditions
- ▶ Scalable display

Local data  
management



- ▶ Processing of drive data for drive and system analysis
- ▶ Condition monitoring

Local dashboard



- ▶ Display of drive and system data

Higher level PLC



- ▶ Processing of condition monitoring information by the customer
- ▶ Combination of the collected condition monitoring data with the process data

3 x AC 400V

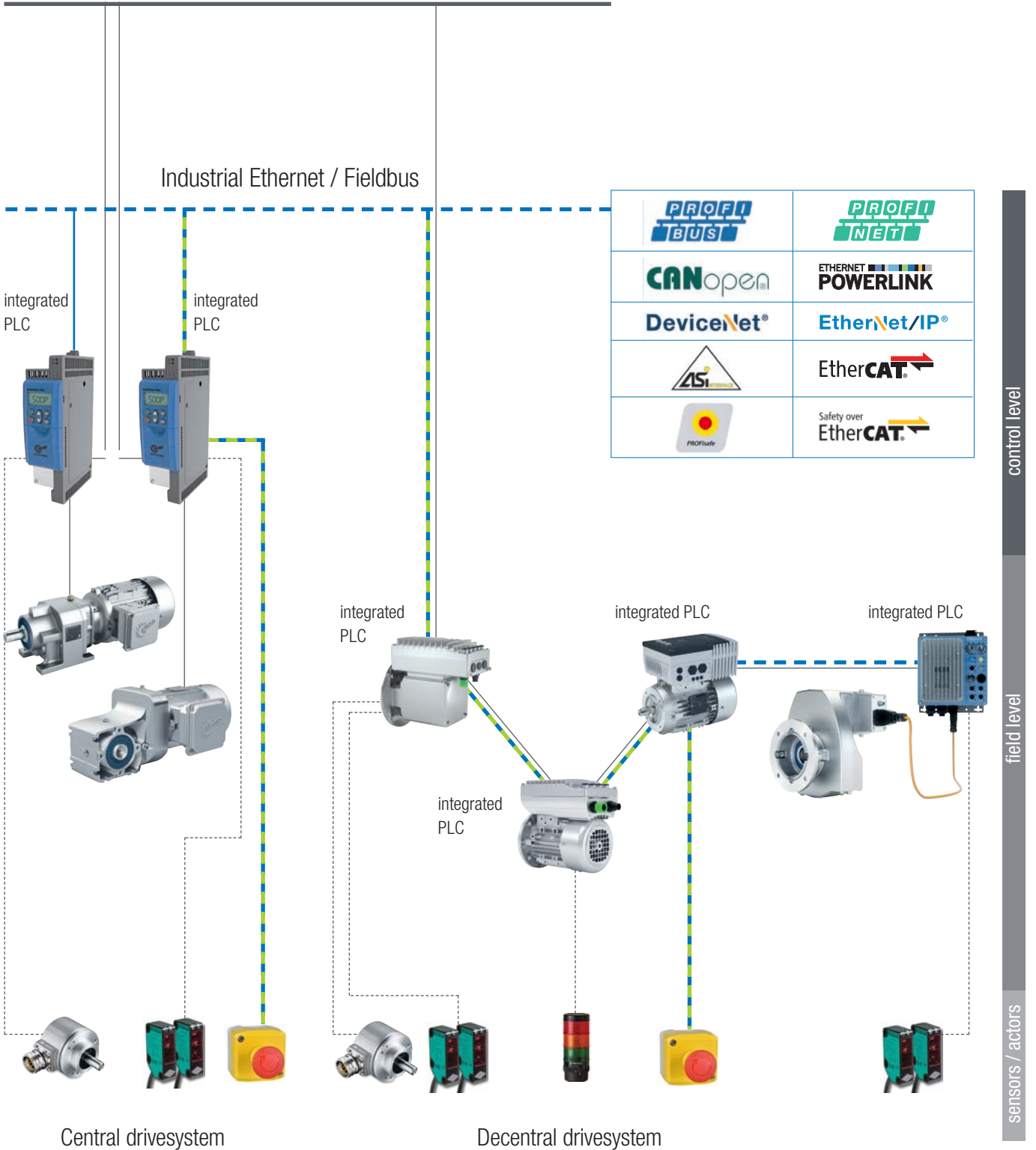

# Drive Solutions for the Packaging Industry

## NORDBLOC.1® Helical Inline Gear Units (Catalog G1000)

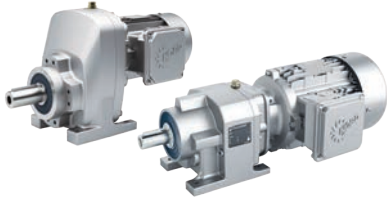

- ✓ Foot or flange-mounted
- ✓ Die-cast iron or aluminum housing
- ✓ UNICASE housing
- ✓ Available in single, double, or triple reduction

Sizes: 16  
Power: 0.16 – 50 hp  
Torque: 266 – 29,207 lb-in  
Ratio: 1.07:1 – 456.77:1

## NORDBLOC.1® 2-Stage Helical Bevel Gear Units (Catalog G1000)



- ✓ Foot, flange, or shaft mounted
- ✓ Hollow or solid shaft
- ✓ Aluminum housing
- ✓ Compact design

Sizes: 6  
Power: 0.16 – 10 hp  
Torque: 443 – 5,842 lb-in  
Ratio: 3.03:1 – 70:1

## UNIVERSAL SI/SMI Worm Gear Units (Catalog G1000)



- ✓ Smooth surface aluminum housing
- ✓ Universal mounting design
- ✓ Life-long lubrication
- ✓ NEMA, IEC, or direct motor mount options

Sizes: 5  
Power: 0.16 – 5.00 hp  
Torque: 186 – 3,780 lb-in  
Ratio: 5.00:1 – 3,000.00:1

## DuoDrive Integrated Gear Unit and Motor (Catalog G5010)



- ✓ Integrated gear unit and motor
- ✓ System efficiency up to 92%
- ✓ Simple plug-and-play commissioning
- ✓ High power density

Sizes: 2  
Power: 0.50 – 4.00 hp  
Torque: 230 – 2,186 lb-in  
Ratio: 3.24:1 – 18.1:1

## NORDAC® START SK 135E Motor Starters (Catalog E3000)



- ✓ Integrated electronic brake rectifier
- ✓ Consistent parameter structure
- ✓ Reversing starter with soft start function

Sizes: 2  
Voltage: 3~ 200 – 240 V, 3~ 380 – 500 V  
Power: 0.16 – 4 hp resp. up to 10 hp



### NORDAC® FLEX SK 200E Variable Frequency Drives (Catalog E3000)



- ✓ Energy saving function
- ✓ Integrated PLC
- ✓ Integrated POSICON positioning control

Sizes: 4  
 Voltage: 1~ 110 – 120 V, 1~ 200 – 240 V, 3~ 200 – 240 V, 3~ 380 – 500 V  
 Power: 0.33 – 30 hp

### NORDAC® LINK SK 250E Field Distributors (Catalog E3000)



- ✓ Variable frequency drive or motor starter
- ✓ All connections in plug-in version for easy commissioning and maintenance
- ✓ PLC functionality for drive-integrated functions

Sizes: 3  
 Voltage: 3~ 380 – 500 V  
 Power: VFD 0.75 – 10 hp; Motor starter 0.16 – 4 hp

### NORDAC® ON/ON+ SK 300P Variable Frequency Drives (Catalog E3000)

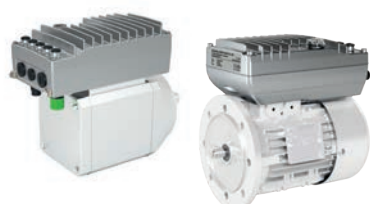

- ✓ Wall or motor mounted
- ✓ Compact design
- ✓ Ethernet communication
- ✓ Plug-and-Play solution

NORDAC ON  
 Sizes: 3  
 Voltage: 3~ 400V  
 Power: 0.50 – 3 hp

NORDAC ON+  
 Sizes: 3  
 Voltage: 3~ 400V  
 Power: 0.50 – 4 hp

### NORDAC® PRO SK 500P Variable Frequency Drives (Catalog E3000)



- ✓ Precise current vector control with high overload reserves for operating asynchronous and synchronous motors
- ✓ Universal interface for real time Ethernet
- ✓ Integrated PLC for drive-related functions even in the basic device

Size: 5  
 Voltage: 1~ 200 – 240 V, 3~ 380 – 480 V  
 Power: 0.33 – 30 hp

### NORDAC® PRO SK 500E Variable Frequency Drives (Catalog E3000)



- ✓ Stand-alone operation
- ✓ Sensorless current vector control (ISD control)
- ✓ 4 parameter sets
- ✓ Integrated PLC

Size: 11  
 Voltage: 1~ 110 – 120 V, 1~ 200 – 240 V, 3~ 200 – 240 V, 3~ 380 – 480 V  
 Power: 0.33 – 200 hp

# Drive Solutions for the Packaging Industry



Wild Goose Bottle filling line

*“NORD played an important role as our supplier and consultant”, says Bakker. “A supplier who supports you and thinks along the same lines provides a great opportunity. This was precisely the case with NORD. Not the quality of the products alone was decisive for us, but also the good relationships which we have built over the past years with NORD as our global partner.”*

**Sacha Bakker,**  
*Managing Director and co-owner of the Dutch engineering company SYMACH*

*“Their dependability is huge, along with the customer support that NORD provides worldwide. With big packaging lines, it’s bad when the bottling line goes down. If this does happen, you can count on NORD to have spare parts delivered quickly.”*

**Roger Walz**  
*Vice President of Sales, Wild Goose Filling*



SYMACH Palletizing Machines

# Ordering is Easy With myNORD Online Tools!

- ▶ Obtain drawing files direct from quote configuration
- ▶ Effortlessly select & configure customized drive solutions
- ▶ Create quotes with account-specific net pricing
- ▶ Order-specific documentation
- ▶ 24/7/365 order tracking
- ▶ Select and order spare parts

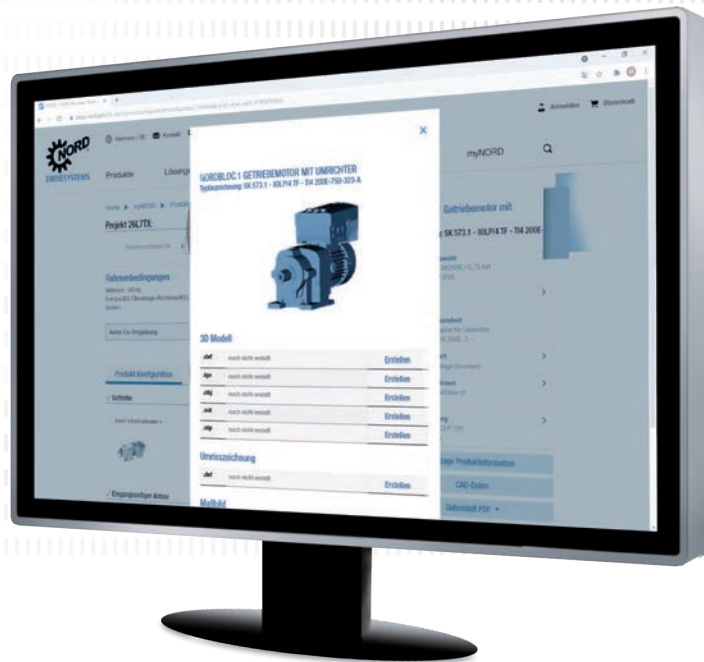

Register now at [myNORD.com](http://myNORD.com)!

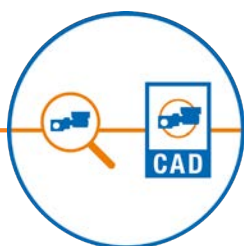

## US

Central Region  
Corporate Headquarters  
800 NORD Drive  
Waunakee, WI 53597  
Tel. 888.314.6673  
info.us@nord.com  
www.nord.com

East Region  
300E Forsyth Hall Dr.  
Charlotte, NC 28273  
Tel. 888.314.6673  
info.us@nord.com

West Region  
1180 Railroad St.  
Corona, CA 92882  
Tel. 888.314.6673  
info.us@nord.com

South Region  
350 Cypress Hill Dr, Suite 400  
McKinney, TX 75071  
Tel. 888.314.6673  
info.us@nord.com

## CA

NORD Gear Limited  
Brampton, ON  
41 West Drive  
Brampton, ON L6T4A1  
Tel. 800.668.4378  
info.ca@nord.com

## MX

NORD DRIVE SYSTEMS SA DE CV  
Queretaro, Mexico  
Av. Industria Textil B.6  
Parque Industrial PYME, Huimilpan  
QRO - Mexico 76950  
Tel. 52 442 688 7110  
info.mx@nord.com