

Variable frequency drive for decentralized applications

NORDAC *BASE* SK 180E series



For standard requirements NORDAC *BASE*, SK 180E series



[NORDAC *BASE*](#)

NORDAC *BASE*

The advantages of using a variable frequency drive to control an electric motor are numerous. Modern VFDs offer typical basic functions such as speed control, communication with control units, precise positioning, and safety functions. However, many applications do not fully utilize the immense scope of functions of modern frequency drives.

To fill the gap which has resulted between simple motor starters and full featured VFDs, NORD has developed a compact model. The NORDAC *BASE* focuses on the essential functions for pumps and conveyor technology (PI / speed control, energy savings, communication with peripherals) and results in significant savings.

- ▶ All common drive functions
- ▶ Leakage current <16 mA
- ▶ Consistent parameter structure
- ▶ Stand-alone operation (integrated 24 V power supply)
- ▶ 3 digital inputs and 2 digital outputs
- ▶ 2 analog inputs (can optionally be used for current or voltage set points, or configured as digital inputs e.g. for sensors)
- ▶ 4 parameter sets which can be switched online
- ▶ Process controller / PI controller
- ▶ Energy saving function: Automatic flux optimization

Optional

- ▶ AS-Interface on board
- ▶ Common bus modules
- ▶ I/O modules
- ▶ System plug connectors (e.g. Harting HAN 10E)
- ▶ Variant for ATEX Zone 22 - 3D
- ▶ Various control options (switches, potentiometer or ParameterBoxes)

Energy-saving functions

- ▶ Automatic flux optimization for pump/fan applications
- ▶ Large energy savings
- ▶ Simple setting via parameters

EMC line filter

Category C1 (Class B)

- ▶ All 230 V / 400 V devices have an integrated line filter
- ▶ Ideal for applications in a domestic environment, due to compliance with Category C1 (for motor-mounting), or Category C2 (for wall mounting with motor cable up to 5 m long)
- ▶ Suitable for personal protection due to low leakage current (< 16 mA) for operation with universal fault current FI circuit breakers

Process controller, PI controller

- ▶ All NORDAC *BASE* devices feature integrated analog inputs
- ▶ P and I components can be set separately
- ▶ High precision regulation

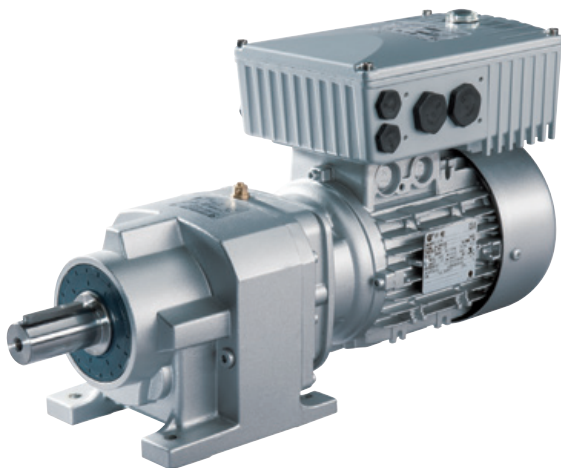

Versatile and sustainable For modern automation systems

Modern automation systems have a wide range of requirements and a suitable bus system and drive components must be selected in order to ensure efficient operation.

The **AS-Interface** is a cost-effective solution which enables the networking of binary sensors and actuators. It is included in certain versions of the NORDAC *BASE*.

The supply voltage (power) is connected separately via the corresponding terminals. An integrated mains unit generates the control voltage for the frequency drive, eliminating the need for an additional AUX cable (black).

Available in SK 190E

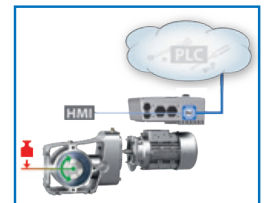
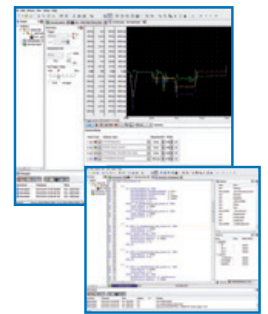
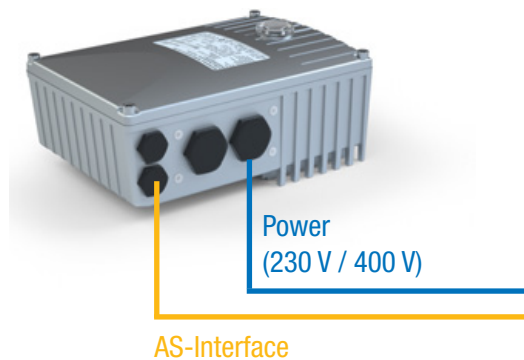



Device SK ...	190E
Follower profile	S-7.A.
Follower type	A/B-Follower
Control voltage	Internal power supply
Inputs/Outputs	4/4
Configuration via parameters	●

Standards and approvals

All devices of the entire series comply with the standards and directives listed below..

Approval	Directive	Applied standards	Certificates	Code
CE (European Union)	Low Voltage Directive 2014/35/EU	EN 61800-5-1	C310400	
	EMC 2014/30/EU	EN 60529	C310401	
	RoHS 2011/65/EU	EN 61800-3 EN 63000		
	Delegated directive (EU) 2015/863	EN 61800-9-1 EN 61800-9-2		
	Ecodesign 2009/125/EG			
	Regulation (EU) 2019/1781 Ecodesign			
UL (USA)		UL 61800-5-1	E171342	
CSA (Canada)		C22.2 No. 274-13	E171342	
EAC (Eurasia)	F2018L00028	EN 61800-3	133520966	
EAC (Eurasia)	TR CU 004/2011, TR CU 020/2011	IEC 61800-5-1 IEC 61800-3	EAЭC N RU Д-DE. HB27.B.02730/20	

Devices which are configured and approved for use in explosion hazard environments comply with the following directives and standards.

Approval	Directive	Applied standards	Certificates	Code
CE (European Union)	Low Voltage Directive 2014/35/EU	EN 60079-0	C432410	
	EMV 2014/30/EU	EN 60079-31		
	RoHS 2011/65/EU	EN 61800-5-1 EN 60529		
	Delegated directive (EU) 2015/863	EN 61800-3 EN 63000		
	Ecodesign 2009/125/EG	EN 61800-9-1 EN 61800-9-2		
	Regulation (EU) 2019/1781 Ecodesign			
EAC Ex (Eurasia)	TR CU 012/2011	IEC 60079-0 IEC 60079-31	TC RU C- DE AA87.B.01109	

Type code

Variable frequency drive

SK 180E-370-323-B (-C) (xxx)

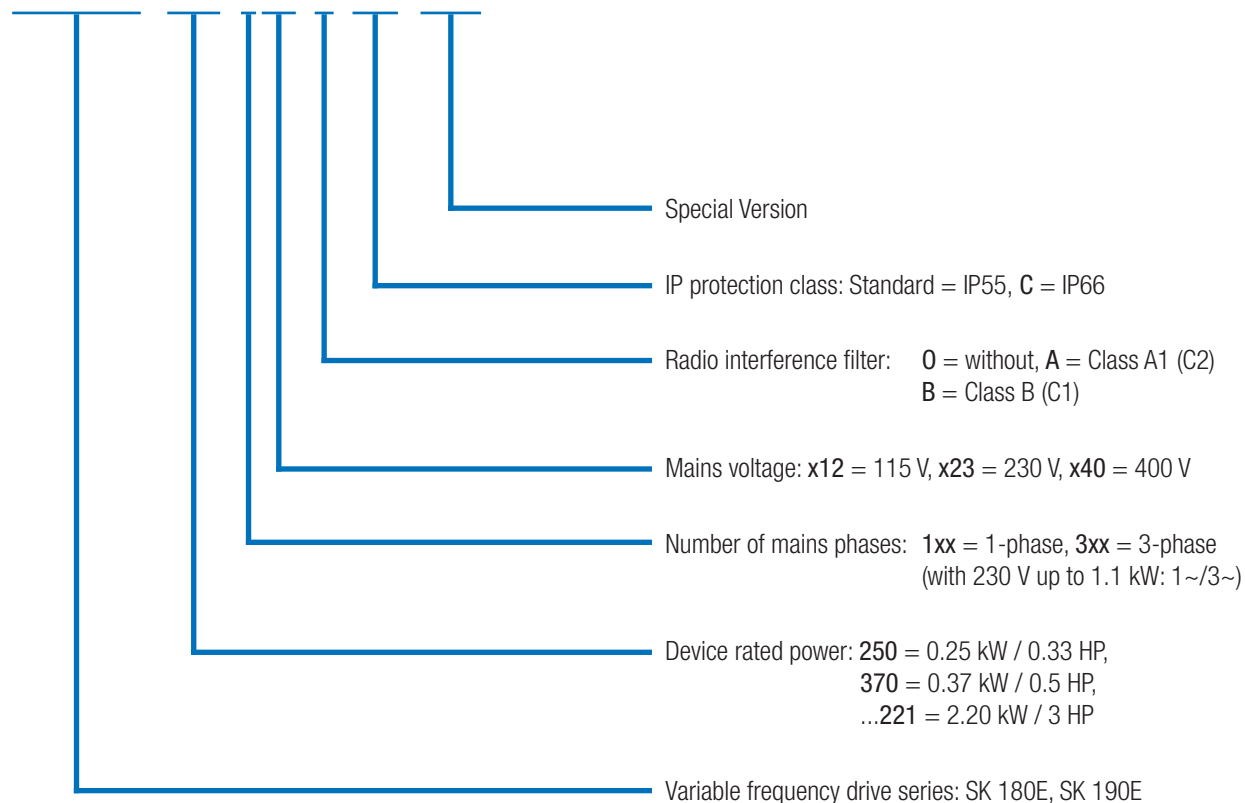

(...) Options, only implemented if required.

Explosive environment protection



ATEX-compliant drive systems, zone 22 3D

The NORDAC *BASE* can be modified for operation in explosive environments. This allows the operation of the frequency drive directly in a hazardous area (ATEX 22-3D). The advantages include:

- ▶ Compact drive unit
- ▶ No complex protective devices
- ▶ No motor cables
- ▶ Optimum EMC
- ▶ Permissible characteristic curves 50 Hz / 87 Hz
- ▶ Control range up to 100 Hz or 3000 rpm

Depending on the area of application (conductive or non-conductive dust) the modification also includes the replacement of the transparent diagnostic caps with a version made of aluminium and glass.

Please note that operation of the device within the hazardous area is only permitted with integrable modules (SK CU4 modules, internal braking resistors) or specially approved accessories (ATEX potentiometer SK ATX-POT).

There are exceptions for SK TU4 modules, which are described in detail in the manual for the device. Other accessories (e.g. external brake resistors, plug connectors) are not approved for use within a hazardous area.

Approval

- ▶ According to 2014/34/EU
- ▶ ATEX Zone 22 - 3D
 - ▶ Version for non-conducting dust: IP55
 - ▶ Version for conducting dust: IP66

Available in all versions



Class I - Gas groups A, B, C, and D

- ▶ Gases, vapors, or aerosols
- ▶ NEC 500
- ▶ Division 1 - Areas in which hazardous concentrations of flammable gases or vapors
 - ▶ Can be present under normal operating conditions
 - ▶ Can frequently occur during repair and maintenance work
 - ▶ Can occur throughout malfunctions concerning operation during which errors occurring in electrical equipment may result in a source of ignition
- ▶ Division 2
 - ▶ Areas in which hazardous concentration of flammable gases or vapors are kept in closed containers or systems and can only be released under fault conditions

Class II - Dust groups E, F and G

- ▶ Dusts
- ▶ NEC 500
- ▶ Division 1 - Areas in which hazardous concentration of explosive dust atmospheres
 - ▶ Can be present under normal operating conditions
 - ▶ Can occur throughout malfunctions concerning operation during which errors occurring in electrical equipment may result in a source of ignition
 - ▶ Areas with hazardous quantities of conductive dust (Group E)
- ▶ Division 2
 - ▶ Areas in which hazardous concentrations of explosive dust atmospheres can only be released under fault conditions

Class III

- ▶ Ignitable fibers and flyings
- ▶ NEC 500
- ▶ Division 1
 - ▶ Areas in which flammable fibers and lint occur or are processed
- ▶ Division 2
 - ▶ Areas in which flammable fibers are stored or handled in a different manner to that in the production process

The entire team

All device versions at a glance

	SK 180E Size 1+2 0.33 - 3 HP	SK 190E Size 1+2 0.33 - 3 HP
Motor and wall mounting possible ¹	●	●
Energy bus - loop-through of mains supply cables ²	●	●
Communication bus for various devices ²	●	●
Sensorless current vector control (ISD control)	●	●
Brake chopper (braking resistor optional) (Size 2 and above)	●	●
RS-232, RS-485 diagnostic interface	●	●
4 switchable parameter sets	●	●
Parameters pre-set with standard values	●	●
Automatic determination of motor data	●	●
Energy-saving function, optimized efficiency in partial load operation	●	●
Integrated EMC line filter according to EN 61800-3, Category C2 up to 5 m motor cable Category C1 for motor assembly	●	●
Extensive monitoring functions	●	●
Load monitor	●	●
PI controller	●	●
Process controller / compensator control	●	●
PLC functionality	●	●
Synchronous motor operation (PMSM)	●	●
Modification for operation in an IT network by means of jumpers	●	●
All common field bus systems	●	●
Brake management for mechanical holding brake	●	●
Lifting gear functionality	●	●
AS-Interface on board	○	●
Internal 24 V power supply unit to supply the control board	●	●
Internal / external brake resistors (Size 2)	●	●
Switch and potentiometer versions	●	●
Plug connectors for connection of control, motor and mains cables	●	●

¹ Wall mounting: wall mounting kit required

Motor mounting: an adapter for connection to the motor terminal box may be necessary

² Direct connection to the terminal bar or via system plug connectors

● Available as standard

● Optional

○ Not available

Control connections on the variable frequency drive

	SK 180E	SK 190E
	Size 1 + 2 0.33 - 3 HP	
Control terminals	Number of digital inputs (DIN)	3
	Number of digital outputs (DOUT)	2
	Number of analog inputs (AIN) ¹	2
	Temperature sensor (PTC)	●
Communication	RS-485 / RS-232	●
	RJ12	●
	AS-I terminal connection	○

¹ 0(2) - 10 V, 0(4) - 20 mA

Connection and control terminals

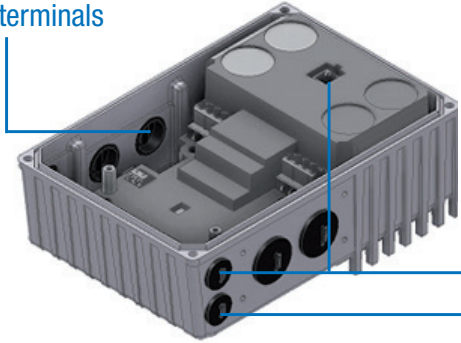

Communication

Note

Control terminals can be supplemented by optional modules (IOs, brake management).

Status and diagnostic cockpit

The RJ12 interface for connection of a diagnostic and parameterization tool (e.g. PC with NORD CON software, ParameterBox) is located behind the transparent cover cap. Analysis, diagnostics, parameterization, and monitoring of the drive unit via software is possible during commissioning or service.

In addition to status and readiness indicators, the current overload level, warnings and error messages are indicated in coded form by the LEDs.



NORDAC *BASE* variable frequency drive

1 ~ 110 ... 120 V , 1 / 3 ~ 200 ... 240 V UND 3 ~ 380 ... 400 V

Output frequency	0.0 ... 400.0 Hz	Protection class	IP55, optional IP66, NEMA1 (higher NEMA classifications on request)
Pulse frequency	3.0 ... 16.0 kHz	Regulation and control	Sensorless current vector control (ISD), linear V/f characteristic curve
Typical overload capacity	150 % for 60 s, 200 % for 3.5 s	Motor temperature monitoring	I ² t Motor PTC / bi-metal switch
Energy efficiency class	IE2	Leakage current	< 16 mA
Efficiency	> 95 %		
Ambient temperature	-25 °C ... +40 °C (S1) -25 °C ... +50 °C (S3, - 70 % ED)		

VFDs SK 180E...	Nominal motor power		Nominal output current rms [A]	Mains voltage	Output voltage
	230 V [kW]	240 V [HP]			
-250-112-0 (-C)	0.25	0.33	1.7	1 ~ 110...120 V -/+10 % 47 ... 63 Hz	3 ~ AC 0 V up to double the mains voltage
-370-112-0 (-C)	0.37	0.5	2.1		
-550-112-0 (-C)	0.55	0.75	3.0		
-750-112-0 (-C)	0.75	1	3.7		

VFDs SK 180E...	Nominal motor power		Nominal output current rms [A]	Mains voltage	Output voltage
	230 V [kW]	240 V [HP]			
-250-323-B (-C)	0.25	0.33	1.7	1/3 ~ 200 ... 240 V, -/+ 10 % 47 ... 63 Hz	3 ~ AC 0 V up to mains voltage
-370-323-B (-C)	0.37	0.5	2.2		
-550-323-B (-C)	0.55	0.75	3.0		
-750-323-B (-C)	0.75	1	4.0		
-111-323-B (-C)	1.1	1.5	5.5		
-151-323-B (-C)	1.5	2	7.0	3 ~ 200 ... 240 V, -/+ 10 % 47 ... 63 Hz	3 ~ AC 0 V up to mains voltage

VFDs SK 180E...	Nominal motor power		Nominal output current rms [A]	Mains voltage	Output voltage
	400 V [kW]	480 V [HP]			
-250-340-B (-C)	0.25	0.33	1.2	3 ~ 380...480 V, -20 % / +10 %, 47 ... 63 Hz	3 ~ AC 0 V up to mains voltage
-370-340-B (-C)	0.37	0.5	1.5		
-550-340-B (-C)	0.55	0.75	1.7		
-750-340-B (-C)	0.75	1	2.3		
-111-340-B (-C)	1.1	1.5	3.1		
-151-340-B (-C)	1.5	2	4.0		
-221-340-B (-C)	2.2	3	5.5		

IP66 measures

- ▶ Coated aluminium components
- ▶ Coated circuit boards
- ▶ Low-pressure test
- ▶ Diaphragm valve

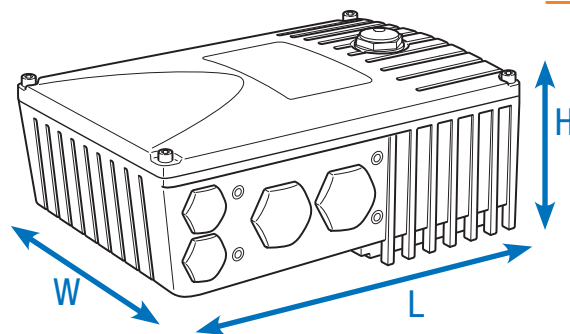

VFDs SK180E ...	Weight		Overall dimensions L x W x H	Size
	[kg]	[lbs]		
-250-112-0 (-C)	2.9	6.4	221 x 154 x 101 mm 8.7 x 6.06 x 3.98 in	1
-370-112-0 (-C)	2.9	6.4		1
-550-112-0 (-C)	2.9	6.4		1
-750-112-0 (-C)	2.9	6.4		1

VFDs SK180E ...	Weight		Overall dimensions L x W x H	Size
	[kg]	[lbs]		
-250-323-B (-C)	2.9	6.4	221 x 154 x 101 mm 8.7 x 6.06 x 3.98 in	1
-370-323-B (-C)	2.9	6.4		1
-550-323-B (-C)	2.9	6.4		1
-750-323-B (-C)	4.1	9.04	254 x 165 x 123 mm 10 x 6.5 x 4.84 in	2
-111-323-B (-C)	4.1	9.04		2
-151-323-B (-C)	4.1	9.04		2

VFDs SK180E ...	Weight		Overall dimensions L x W x H	Size
	[kg]	[lbs]		
-250-340-B (-C)	2.9	6.4	221 x 154 x 101mm 8.7 x 6.06 x 3.98 in	1
-370-340-B (-C)	2.9	6.4		1
-550-340-B (-C)	2.9	6.4		1
-750-340-B (-C)	2.9	6.4		1
-111-340-B (-C)	2.9	6.4		1
-151-340-B (-C)	4.1	9.04	254 x 165 x 123 mm 10 x 6.5 x 4.84 in	2
-221-340-B (-C)	4.1	9.04		2

Varied installation possibilities

Motor Assembly

The VFD can be mounted directly on the terminal box of the (geared) motor, forming an optimized complete unit. This motor-mounted format provides numerous advantages: compact overall dimensions of the drive unit, quick readiness for use after connection to the mains supply due to pre-configuration of the drive unit at the factory, and optimum EMC due to short cable lengths or elimination of a motor cable.

Wall mounting

As an alternative to motor mounting, the device can be mounted close to the motor with the aid of a wall mounting kit. Different versions are available depending on the application.

1. Standard version SK TIE4-WMK-1-K

Note: If the VFD is wall mounted, the cooling air flow from the motor is not present. This can result in power restrictions (derating) for the frequency drive.

2. ATEX version SK TIE4-WMK-1-EX

This version is functionally comparable to the standard version and suitable for use in explosion hazard environments (ATEX Zone 22 3D).

Designation	Material No.	VFDs ¹ for size FI
SK TIE4-WMK-1-K	275 274 004	Size 1, 2
SK TIE4-WMK-1-EX	275 175 053	Size 1, 2
SK TIE4-WMK-TU ²	275 274 002	Typ: SK TU4-

¹ Mounting of the WMK underneath the motor starter

² Mounting of the WMK on the connection unit of the technology unit

Motor-mounted or wall-mounted VFDs

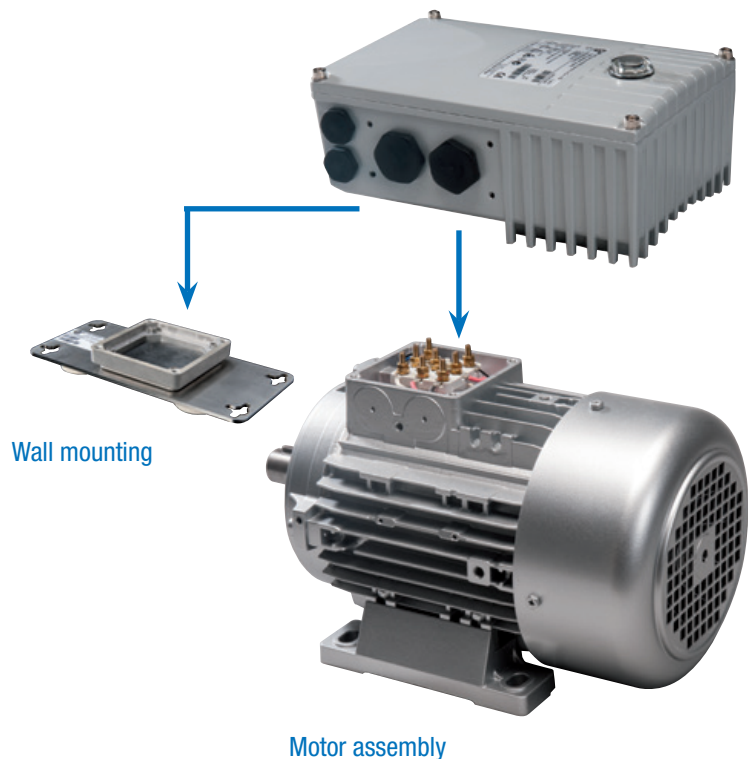

Designation	Material	Integrated fan	Achievable protection class	Weight	Overall dimensions L x W x H	Remarks
SK TIE4-WMK-1-K	Plastic	○	IP66	0.2 kg 0.44 lbs	205 x 95 x 5 mm 8.07 x 3.74 x 0.2 in	Note: derating as necessary
SK TIE4-WMK-1-EX	Stainless steel	○	IP66	0.6 kg 0.97 lbs	205 x 95 x 4 mm 8.04 x 3.74 x 0.16 in	Note: derating as necessary
SK TIE4-WMK-TU	Stainless steel	○	IP66	0.4 kg 0.88 lbs	155 x 85 x 3 mm 6.10 x 3.35 x 0.12 in	

¹ H = Increase in the total height of the device if mounted on the wall mounting kit

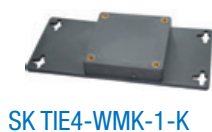
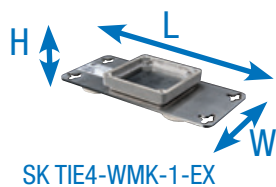

Technology unit on NORDAC *BASE* or wall mounting

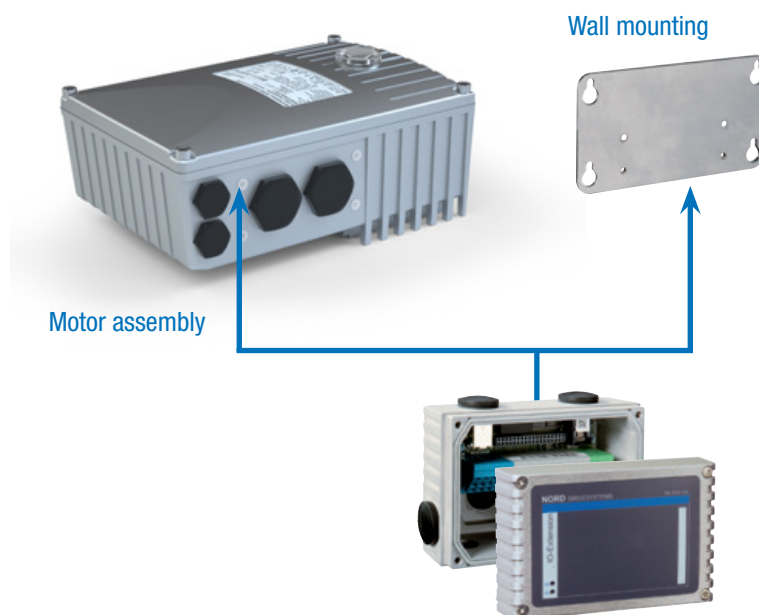

Brake resistors (only for Size 2 devices)

internal versions

Internal braking resistors SK BRI4

Internal brake resistors are intended for applications in which slight or only sporadic and brief braking (e.g. continuous conveyor equipment, mixing equipment) is to be expected. They enable the use of the variable frequency drive in very confined spaces or in an explosive atmosphere.

Internal brake resistors are intended for installation in the connection unit of the VFD. The units offer space for implementing one brake resistor each. For thermal reasons, the rated continuous output is limited to 25%.

Equipment with a brake resistor has to be specified when ordering as retrofitting is not possible.



VFDs SK 180E / SK190E	Resistor type	Material No.	Resistance [Ω]	Continuous output ¹ [W]	Power consumption ² [kW]
1/3~ 230 V 0.75 ... 1.5 kW 1 ... 2 HP	SK BRI4-1-200-100	275 272 008	200	100 / 25 %	1.0
3~ 400 V 1.5 ... 2.2 kW 2 ... 3 HP	SK BRI4-1-400-100	275 272 012	400	100 / 25 %	1.0

¹ Reduction of the continuous output of the braking resistor to 25% of the rated output

² Permissible max. once within 10 s

Brake resistors (ONLY FOR SIZE 2 DEVICES) external versions

External braking resistors SK BRE4

External braking resistors (IP67) are intended for applications in which longer, frequent or intensive braking is to be expected (cyclic operation / highly dynamic positioning applications). They are mounted directly on the VFD and can develop high surface temperatures (>70 °C), which exclude their use in an explosive atmosphere.

Note

The brake resistors listed here are designed for typical applications with occasional braking. In case of doubt or for applications with higher braking power such as lifting equipment, we recommend targeted planning of the necessary brake resistor and contacting NORD DRIVESYSTEMS directly.

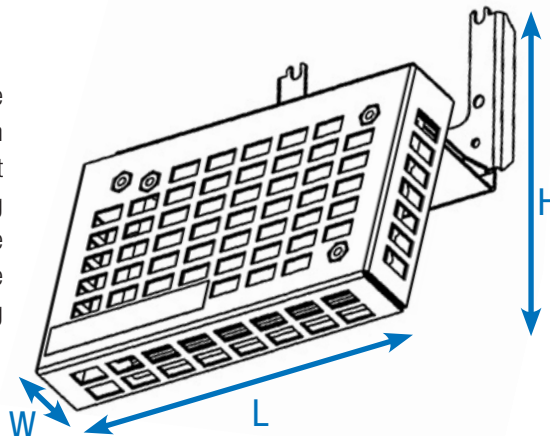

VFDs SK 180E / SK190E	Resistor type Material No.	Resistance [Ω]	Continuous output [W]	Power consumption ¹ [kW]	Overall dimensions L x W x H
1/3~ 230V 0.75 ... 1.5 kW 1 ... 2 HP	SK BRE4-1-100-100 275 273 005	100	100	2.2	150 x 61 x 178 mm 5.9 x 2.4 x 7 in
	Alternatively: SK BRE4-2-100-200 275 273 105	100	200	4.4	255 x 61 x 178 mm 10.03 x 2.4 x 7 in
3~ 400V 1.5 ... 2.2 kW 2 ... 3 HP	SK BRE4-1-200-100 275 273 008	200	100	2.2	150 x 61 x 178 mm 5.9 x 2.4 x 7 in
	Alternatively: SK BRE4-2-200-200 275 273 108	200	200	4.4	255 x 61 x 178 mm 10.03 x 2.4 x 7 in

¹ Permissible max. once within 120 s

US

NORD Gear Corporation
Waunakee, WI
800 NORD Drive
Waunakee, WI 53597
Tel. 888.314.6673
info.us@nord.com
www.nord.com

Corona, CA
1180 Railroad St.
Corona, CA 92882
Tel. 888.314.6673
info.us@nord.com

Charlotte, NC
300E Forsyth Hall Dr.
Charlotte, NC 28273
Tel. 888.314.6673
info.us@nord.com

CA

NORD Gear Limited
Brampton, ON
41 West Drive
Brampton, ON L6T4A1
Tel. 800.668.4378
info.ca@nord.com

MX

NORD DRIVE SYSTEMS SA DE CV
Queretaro, Mexico
Av. Industria Textil B.6
Parque Industrial PYME, Huimilpan
QRO - Mexico 76950
Tel. 52 442 688 7110
info.mx@nord.com