

# GETRIEBEBAU NORD

Member of the NORD DRIVESYSTEMS Group

Getriebebau NORD GmbH & Co. KG

Getriebebau-Nord-Straße 1 • 22941 Bargteheide, Germany • www.nord.com



## SK BRU5-1-240-050

Part number: 275 299 004

Footprint braking resistor for connection  
to a NORDAC PRO SK 500P



It only is allowed for qualified electricians to install and commission the module. An electrician is a person who, because of their technical training and experience, has sufficient knowledge relating to

- switching on, switching off, isolating, earthing and marking power circuits and devices,
- proper maintenance and use of protective devices in accordance with defined safety standards.

### DANGER!

#### Danger of electric shock

The frequency inverter continues to carry hazardous voltages for up to 5 minutes after it was switched off.

- Work must not be carried out unless the device has been disconnected from the voltage and at least 5 minutes have elapsed since the mains was switched off!

### CAUTION

#### Danger of burns

The module and all other metal components can heat up to temperatures above 70 °C.

- Sufficient cooling time must be allowed for when working on the components in order to avoid injuries (local burns) to parts of the body coming into contact with the components.
- In order to avoid damage to neighbouring objects, sufficient clearance must be maintained during installation.

### NOTICE

#### Validity of this document

This document is only valid in combination with the operating instructions for the relevant frequency inverter. Safe commissioning of this module and the frequency inverter depends on the availability of this information.

Technical Information / Datasheet	SK BRU5-1-240-050			
Brake resistor	275299004	1.0	0821	en

**Scope of delivery**

Module		
1 x	<b>Bottom-mounted braking resistor</b>	SK BRU5-1-...
2 x	<b>Fastening screws</b>	M4 x 12 (in the accessories kit)



**Field of use**

Dynamic braking (frequency lowering) of a three-phase motor via a frequency inverter results in generator braking energy that – depending on the particular application – is dissipated by a braking resistor. This excess energy is converted into heat.

The footprint braking resistor is intended for use with the NORDAC *PRO* SK 500P device series.



Similar to illustration

**Technical Data**
*Electrical data*

<b>Number of wires</b>		2
<b>Resistance</b>	Ω	240
<b>Max. continuous power P<sub>n</sub></b>	W	50
<b>Max. pulse energy capacity 1)</b>	kJ	3.2

<b>Short-time power P<sub>max 2)</sub></b>		
for 1.2 s	kW	0.75
<b>Rated power P</b>	W	≤ 80

<sup>1)</sup> The stated value applies to a single use < 1 s at an ambient temperature of 40°C.

<sup>2)</sup> The stated value applies to a single use within 120 s.

*General*

<b>Temperature range</b>	°C	-10 ... 40 (100% ED/S1) -10 ... 50 (70% ED/S3)
<b>Tightening torque</b> Screws	Nm	1.1 – 1.5
<b>Weight</b>	kg	≈ 0.31

<b>Approvals</b>	CE, RoHS, UL recognition
<b>Protection class</b>	IP65
<b>Mounting</b> Screws Screws <sup>1)</sup>	2 x M4 x 12 (SK 5xxP) 2 x M5 x 8 (mounting surface)

<sup>1)</sup> Not included in the scope of delivery

*Dimensions*

<b>Overall dimensions (W x H x D)</b>	mm	65 x 35 x 235
---------------------------------------	----	---------------

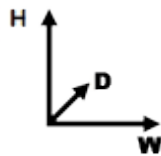
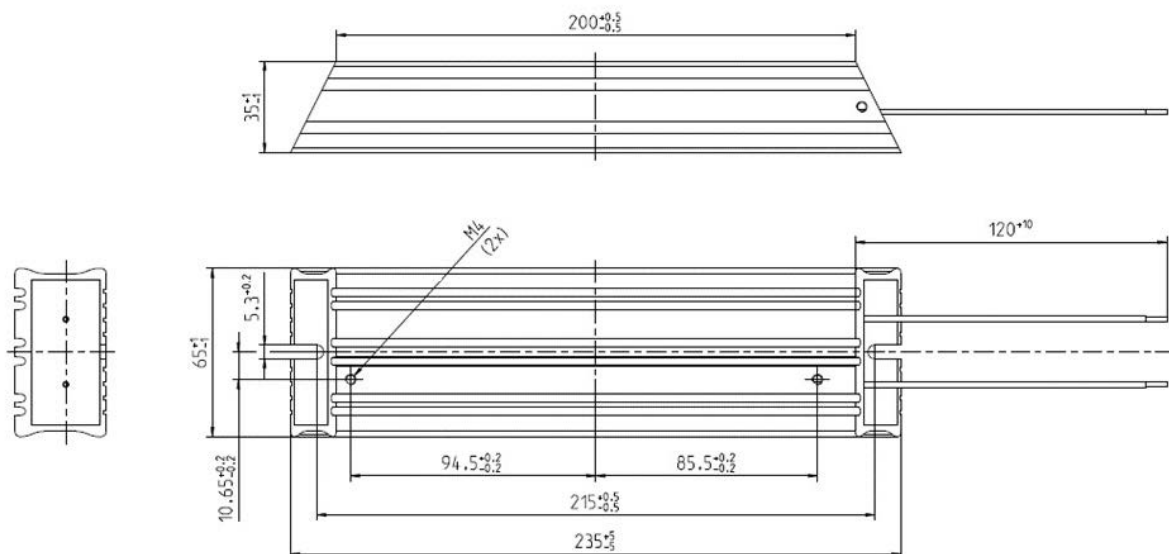
*Dimensioning drawing*

### Connections



Designation	B+	B-
Cross section / type	AWG 18	
Wire colour	White	

### Assignment to frequency inverters

#### Information

Overview in the manual

The footprint braking resistors provided by the NORD DRIVESYSTEMS Group are directly tailored to the individual frequency inverters.

For detailed information, please refer to the frequency inverter manual  "Further documentation and software [www.nord.com](http://www.nord.com)", chapter  braking resistor (BR).

#### Maintenance information

In order to ensure the dissipation of heat energy from the resistor body and the connecting cables, these must be free from dirt during operation.

Due to temperature development on the resistor's surface, deposits of flammable material must be avoided in order to avoid ignition.

Cleaning of the resistor must be carried out with a dry duster on a regular basis when the resistor has completely cooled down. The use of detergents for cleaning the resistor is generally not permitted.

For detailed information, please refer to the Maintenance and service information chapter in the BU 0600 manual, see  "Further documentation and software [www.nord.com](http://www.nord.com)".

#### CAUTION

##### Overload

In case of overload, the braking resistor would be subject to significantly increased heat. Depending on the overload degree, this may lead to overheating which permanently damages or even destroys the braking resistor. As this can be accompanied by risk of fire for components in the vicinity of the resistor, such overloads must be detected and avoided at an early stage.

- Use optional temperature switch
- Monitoring via parameter settings

## Temperature monitoring

For connection to the frequency inverter, a temperature switch (bi-metal) is optionally available in two versions for temperature monitoring of the footprint braking resistor. The trigger characteristic selection depends on the installation position / mounting of the braking resistor.

### Installation in the vicinity of the frequency inverter



Nominal temperature of 180°C  
Part No. 275991100

### Direct installation below the frequency inverter

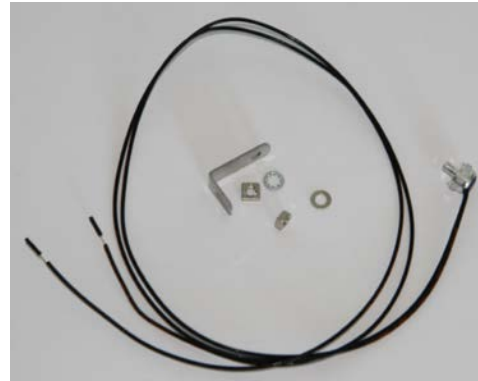

Nominal temperature of 100°C  
Part No. 275991200

## Information

The enclosed temperature switch fastening material is not required for mounting at the SK 5xxP frequency inverter.

## NOTICE

### Impermissible heating

If the footprint braking resistor is mounted directly below the frequency inverter, a temperature switch with a nominal switch-off temperature of 100°C (Part No. 275991200) must be used. This is necessary to prevent impermissible heating of the frequency inverter.

- Failure to observe this may result in damage to the cooling system of the frequency inverter (fan).

## Technical Data

### General

<b>Switching temperature</b>	°C	100 ± 5 180 ± 5
<b>Tightening torque</b> Bimetallic switch	Nm	1.8 – 2.0
<b>Weight</b>	kg	≈ 0.05

<b>Approvals</b>	CE, RoHS, UL	
<b>Protection class</b>	IP40	
<b>Mounting</b>		
Threads	M4	
Wrench size	10	

### Electrical data

<b>Number of wires</b>		2
<b>Voltage</b>	V	250 AC 24 DC

<b>Switching cycles</b>		10000	
<b>Current</b>	AC	A	2.5 <sup>1)</sup> / 1.6 <sup>2)</sup>
	DC	A	2.0

<sup>1)</sup> Stated value is  $\cos \varphi = 1$ .

<sup>2)</sup> Stated value is  $\cos \varphi = 0.6$ .

*Dimensions*

<b>Overall dimensions (W x H x D)</b>	mm	11 x 12 x 10
<b>Mounting (L)</b> M4 thread	mm	5
<b>Cable / line</b> Wire length	mm	50
Wire end sleeve	mm	10

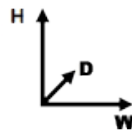

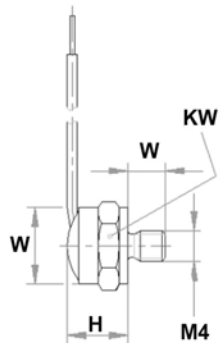

*Dimension drawing*



**Installation**

<b>Installation location</b>	Direct mounting or in the vicinity of the centralised NORDAC <i>PRO</i> frequency inverter. <ul style="list-style-type: none"> <li>• Below the frequency inverter</li> <li>• In the vicinity of the SK 5xxP within the control cabinet</li> </ul>
<b>Mounting position</b>	Lying flat on vertical mounting surfaces.
<b>Mounting</b>	With screw fasteners <ul style="list-style-type: none"> <li>• Screws for mounting are partially included in the scope of delivery</li> </ul>

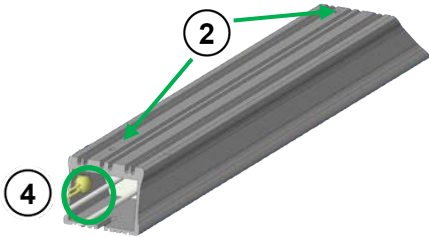
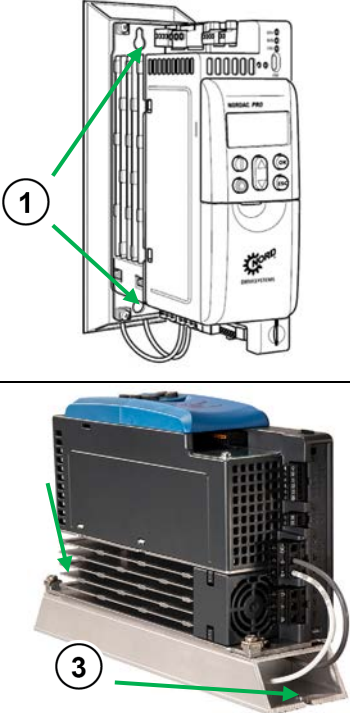
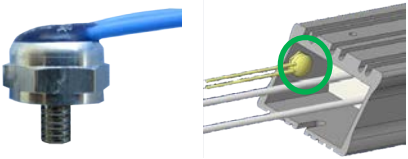
**Installation steps**

<p>1. Direct installation below the frequency inverter Correctly mount the frequency inverter with the 2 provided fastening screws (M4 x 12) on the braking resistor.</p> <ul style="list-style-type: none"> <li>• ① For frequency inverter on ② braking resistor</li> <li>• ③ Braking resistor on mounting surface</li> </ul>  <p>Installation in the vicinity of the frequency inverter Correctly mount the braking resistor on the wall or the mounting surface close to the frequency inverter in a horizontal position with the 2 fastening screws which are provided.</p> <ul style="list-style-type: none"> <li>• ① For frequency inverter on mounting surface</li> <li>• ③ Braking resistor on mounting surface</li> </ul>	 <p>Similar to illustration</p>
<p>2. Installation of optional temperature monitoring ④ Install temperature switch (Part No. 275991100 or 275991200) on the braking resistor.</p> <ul style="list-style-type: none"> <li>• Vertical mounting primarily on the inside of the aluminium profile</li> <li>• Screw thread into the mounting hole</li> <li>• Fasten (M6) with open-ended spanner (SW10)</li> </ul>	
<p>3. Connection to the frequency inverter Connect the braking resistor wires on the underside of the frequency inverter to the terminal block X3.</p> <p>Wire 1      B- Wire 2      B+</p> <p>Comply with specified tightening torques (see  Technical Data – General).</p> <p>Connect the optional temperature switch wires on the front side of the frequency inverter to the terminal block X11.</p> <p>Wire 1      Digital input Wire 2      Voltage supply</p>	

## Information

In order to use the signal from the temperature switch it must be connected to a free digital input of the frequency inverter and, for example, parameterised with the function "Voltage block" or "Quick stop".

Switching power of the normally closed contact:

- 2 A at 24 V DC
- 2 A / 230 V AC

For detailed information, please refer to the frequency inverter manual  "Further documentation and software [www.nord.com](http://www.nord.com)".

## Parameter

For optimum operation of the braking resistor, the following frequency inverter parameters need to be changed.

Parameter	Meaning	Remarks
P556	Braking resistor	Value of the braking resistor for calculation of the maximum brake power in order to protect the resistor. <ul style="list-style-type: none"> <li>• Error I<sup>2</sup>t limit (E003.1) is triggered. For further details, see  in P737.</li> </ul>
P557	Brake resistor type	Continuous power (nominal power) of the resistor, to display the actual utilisation in P737. For a correctly calculated value, the correct value must be entered into P556 and P557. <ul style="list-style-type: none"> <li>• 0.00 = Off, monitoring disabled</li> </ul>
P700	Actual operating status	This parameter holds information on the actual operating status of the frequency inverter, such as fault, maintenance, and reason for switch-on inhibit.
P701	Last fault	This parameter holds information on the frequency inverter's last faults.
P737	Usage rate brakeres.	This parameter holds information on the actual usage degree of the brake chopper or the actual utilisation of the braking resistor in generator mode. <ul style="list-style-type: none"> <li>• Depending on parameter settings P556 and P557.</li> <li>• If both are correctly set, the resistance is displayed.</li> </ul>

Refer to the frequency inverter manual for details  "Further documentation and software [www.nord.com](http://www.nord.com)".

## Error messages

Error messages from the braking resistor - the current or archived message for the last fault - can be read out from the information parameter Current Fault P700 and the Last Fault P701 in the error memory of the frequency inverter.

Error (E030/E050)	Meaning	Remarks
3.1	I <sup>2</sup> t overcurrent limit	Brake chopper: I <sup>2</sup> t limit has been triggered, 1.5x value for 60 s reached (  P556, P557) <ul style="list-style-type: none"> <li>• Avoid overcurrent in braking resistor</li> </ul>
5.0	Overvoltage Ud	Link circuit voltage too high <ul style="list-style-type: none"> <li>• Check the function of the braking resistor (cable break)</li> <li>• Resistance of connected braking resistor too high</li> </ul>

Refer to the frequency inverter manual for details  "Further documentation and software [www.nord.com](http://www.nord.com)".



**Connection diagram**

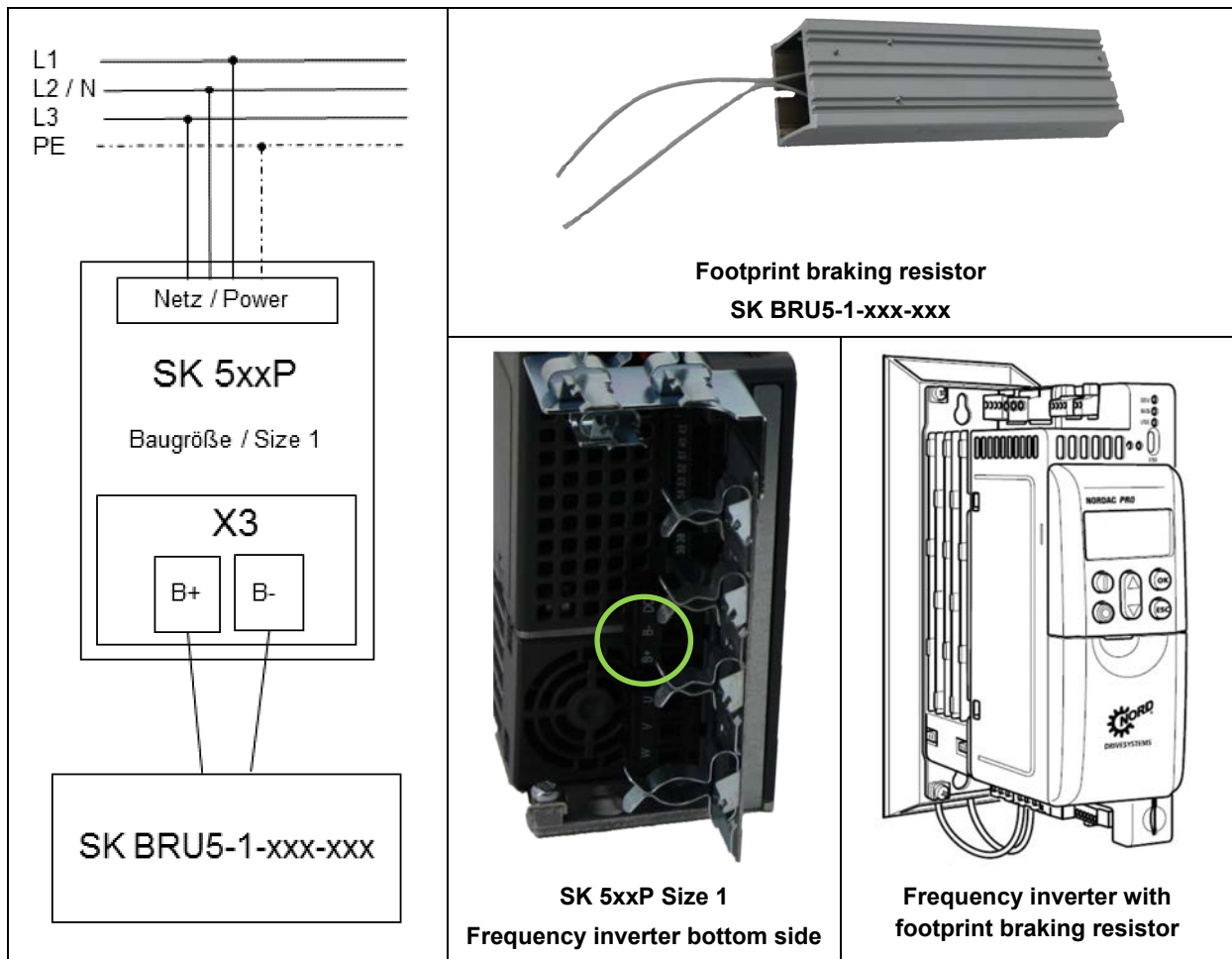

Further documentation and software [www.nord.com](http://www.nord.com)

Document	Designation
<a href="#">BU_0600</a>	Frequency inverter manual SK 500P – SK 550P

Document	Designation
<a href="#">F3060_E3000</a>	Flyer NORDAC PRO SK 500P

## SK BRU5-1-400-100

Part number: 275 299 101

Footprint braking resistor for connection  
to a NORDAC PRO SK 500P



It only is allowed for qualified electricians to install and commission the module. An electrician is a person who, because of their technical training and experience, has sufficient knowledge relating to

- switching on, switching off, isolating, earthing and marking power circuits and devices,
- proper maintenance and use of protective devices in accordance with defined safety standards.

### **DANGER!**

#### **Danger of electric shock**

The frequency inverter continues to carry hazardous voltages for up to 5 minutes after it was switched off.

- Work must not be carried out unless the device has been disconnected from the voltage and at least 5 minutes have elapsed since the mains was switched off!

### **CAUTION**

#### **Danger of burns**

The module and all other metal components can heat up to temperatures above 70 °C.

- Sufficient cooling time must be allowed for when working on the components in order to avoid injuries (local burns) to parts of the body coming into contact with the components.
- In order to avoid damage to neighbouring objects, sufficient clearance must be maintained during installation.

### **NOTICE**

#### **Validity of this document**

This document is only valid in combination with the operating instructions for the relevant frequency inverter. Safe commissioning of this module and the frequency inverter depends on the availability of this information.

Technical Information / Datasheet	SK BRU5-1-400-100			
Brake resistor	275299101	1.0	0821	en

**Scope of delivery**

Module		
1 x	<b>Bottom-mounted braking resistor</b>	SK BRU5-1-...
2 x	<b>Fastening screws</b>	M4 x 12 (in the accessories kit)



**Field of use**

Dynamic braking (frequency lowering) of a three-phase motor via a frequency inverter results in generator braking energy that – depending on the particular application – is dissipated by a braking resistor. This excess energy is converted into heat.

The footprint braking resistor is intended for use with the NORDAC *PRO* SK 500P device series.



Similar to illustration

**Technical Data**
*Electrical data*

<b>Number of wires</b>		2
<b>Resistance</b>	Ω	400
<b>Max. continuous power P<sub>n</sub></b>	W	100
<b>Max. pulse energy capacity 1)</b>	kJ	2.6

<b>Short-time power P<sub>max 2)</sub></b>		
for 1.2 s	kW	1.5
<b>Rated power P</b>	W	≤ 80

<sup>1)</sup> The stated value applies to a single use < 1 s at an ambient temperature of 40°C.

<sup>2)</sup> The stated value applies to a single use within 120 s.

*General*

<b>Temperature range</b>	°C	-10 ... 40 (100% ED/S1) -10 ... 50 (70% ED/S3)
<b>Tightening torque</b> Screws	Nm	1.1 – 1.5
<b>Weight</b>	kg	≈ 0.31

<b>Approvals</b>	CE, RoHS, UL recognition
<b>Protection class</b>	IP65
<b>Mounting</b> Screws Screws <sup>1)</sup>	2 x M4 x 12 (SK 5xxP) 2 x M5 x 8 (mounting surface)

<sup>1)</sup> Not included in the scope of delivery

*Dimensions*

<b>Overall dimensions (W x H x D)</b>	mm	65 x 35 x 235
---------------------------------------	----	---------------

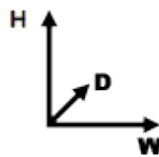
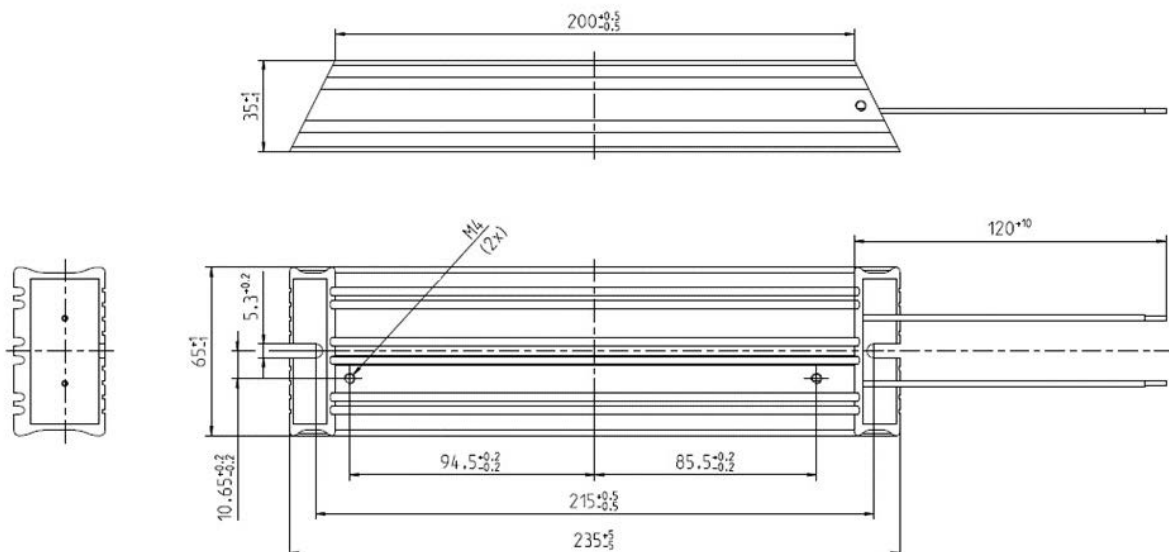
*Dimensioning drawing*

*Connections*



Designation	B+	B-
Cross section / type	AWG 18	
Wire colour	White	

**Assignment to frequency inverters**

 **Information**

Overview in the manual

The footprint braking resistors provided by the NORD DRIVESYSTEMS Group are directly tailored to the individual frequency inverters.

For detailed information, please refer to the frequency inverter manual  "Further documentation and software [www.nord.com](http://www.nord.com)", chapter  braking resistor (BR).

**Maintenance information**

In order to ensure the dissipation of heat energy from the resistor body and the connecting cables, these must be free from dirt during operation.

Due to temperature development on the resistor's surface, deposits of flammable material must be avoided in order to avoid ignition.

Cleaning of the resistor must be carried out with a dry duster on a regular basis when the resistor has completely cooled down. The use of detergents for cleaning the resistor is generally not permitted.

For detailed information, please refer to the Maintenance and service information chapter in the BU 0600 manual, see  "Further documentation and software [www.nord.com](http://www.nord.com)".

 **CAUTION**

**Overload**

In case of overload, the braking resistor would be subject to significantly increased heat. Depending on the overload degree, this may lead to overheating which permanently damages or even destroys the braking resistor. As this can be accompanied by risk of fire for components in the vicinity of the resistor, such overloads must be detected and avoided at an early stage.

- Use optional temperature switch
- Monitoring via parameter settings

### Temperature monitoring

For connection to the frequency inverter, a temperature switch (bi-metal) is optionally available in two versions for temperature monitoring of the footprint braking resistor. The trigger characteristic selection depends on the installation position / mounting of the braking resistor.

#### Installation in the vicinity of the frequency inverter



Nominal temperature of 180°C  
Part No. 275991100

#### Direct installation below the frequency inverter

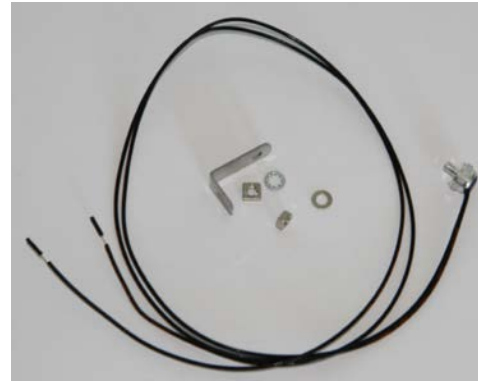

Nominal temperature of 100°C  
Part No. 275991200

### Information

The enclosed temperature switch fastening material is not required for mounting at the SK 5xxP frequency inverter.

### NOTICE

#### Impermissible heating

If the footprint braking resistor is mounted directly below the frequency inverter, a temperature switch with a nominal switch-off temperature of 100°C (Part No. 275991200) must be used. This is necessary to prevent impermissible heating of the frequency inverter.

- Failure to observe this may result in damage to the cooling system of the frequency inverter (fan).

### Technical Data

#### General

<b>Switching temperature</b>	°C	100 ± 5 180 ± 5
<b>Tightening torque</b> Bimetallic switch	Nm	1.8 – 2.0
<b>Weight</b>	kg	≈ 0.05

<b>Approvals</b>	CE, RoHS, UL	
<b>Protection class</b>	IP40	
<b>Mounting</b>		
Threads	M4	
Wrench size	10	

#### Electrical data

<b>Number of wires</b>		2
<b>Voltage</b>	V	250 AC 24 DC

<b>Switching cycles</b>		10000
<b>Current</b> AC	A	2.5 <sup>1)</sup> / 1.6 <sup>2)</sup>
DC	A	2.0

<sup>1)</sup> Stated value is  $\cos \varphi = 1$ .

<sup>2)</sup> Stated value is  $\cos \varphi = 0.6$ .

Brake resistor – SK BRU5-1-400-100

*Dimensions*

<b>Overall dimensions (W x H x D)</b>	mm	11 x 12 x 10
<b>Mounting (L)</b> M4 thread	mm	5
<b>Cable / line</b> Wire length	mm	50
Wire end sleeve	mm	10

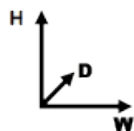



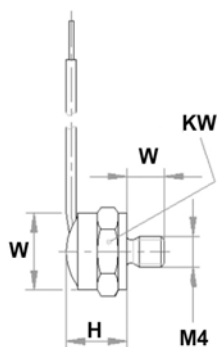



*Dimension drawing*

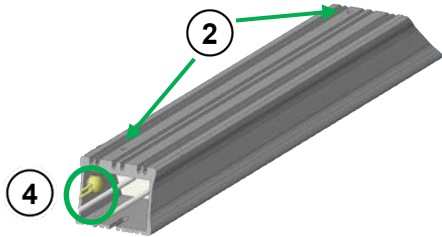
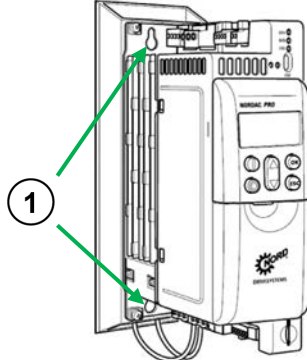

**Installation**

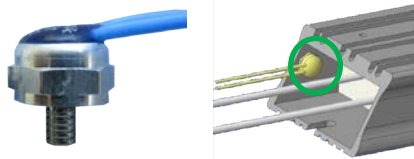
<b>Installation location</b>	Direct mounting or in the vicinity of the centralised NORDAC <i>PRO</i> frequency inverter. <ul style="list-style-type: none"> <li>• Below the frequency inverter</li> <li>• In the vicinity of the SK 5xxP within the control cabinet</li> </ul>
<b>Mounting position</b>	Lying flat on vertical mounting surfaces.
<b>Mounting</b>	With screw fasteners <ul style="list-style-type: none"> <li>• Screws for mounting are partially included in the scope of delivery</li> </ul>

*Installation steps*

1.	<p>Direct installation below the frequency inverter                  Correctly mount the frequency inverter with the 2 provided fastening screws (M4 x 12) on the braking resistor.</p> <ul style="list-style-type: none"> <li>• ① For frequency inverter on ② braking resistor</li> <li>• ③ Braking resistor on mounting surface</li> </ul>  <p>Installation in the vicinity of the frequency inverter                  Correctly mount the braking resistor on the wall or the mounting surface close to the frequency inverter in a horizontal position with the 2 fastening screws which are provided.</p> <ul style="list-style-type: none"> <li>• ① For frequency inverter on mounting surface</li> <li>• ③ Braking resistor on mounting surface</li> </ul>	  <p>Similar to illustration</p>
2.	<p>Installation of optional temperature monitoring                  ④ Install temperature switch (Part No. 275991100 or 275991200) on the braking resistor.</p> <ul style="list-style-type: none"> <li>• Vertical mounting primarily on the inside of the aluminium profile</li> <li>• Screw thread into the mounting hole</li> <li>• Fasten (M6) with open-ended spanner (SW10)</li> </ul>	
3.	<p>Connection to the frequency inverter                  Connect the braking resistor wires on the underside of the frequency inverter to the terminal block X3.</p> <p>Wire 1      B-                  Wire 2      B+</p> <p>Comply with specified tightening torques (see  Technical Data – General).</p> <p>Connect the optional temperature switch wires on the front side of the frequency inverter to the terminal block X11.</p> <p>Wire 1      Digital input                  Wire 2      Voltage supply</p>	 



## Information

In order to use the signal from the temperature switch it must be connected to a free digital input of the frequency inverter and, for example, parameterised with the function "Voltage block" or "Quick stop".

Switching power of the normally closed contact:

- 2 A at 24 V DC
- 2 A / 230 V AC

For detailed information, please refer to the frequency inverter manual  "Further documentation and software [www.nord.com](http://www.nord.com)".

## Parameter

For optimum operation of the braking resistor, the following frequency inverter parameters need to be changed.

Parameter	Meaning	Remarks
<b>P556</b>	Braking resistor	Value of the braking resistor for calculation of the maximum brake power in order to protect the resistor. <ul style="list-style-type: none"> <li>• Error I<sup>2</sup>t limit (E003.1) is triggered. For further details, see  in P737.</li> </ul>
<b>P557</b>	Brake resistor type	Continuous power (nominal power) of the resistor, to display the actual utilisation in P737. For a correctly calculated value, the correct value must be entered into P556 and P557. <ul style="list-style-type: none"> <li>• 0.00 = Off, monitoring disabled</li> </ul>
<b>P700</b>	Actual operating status	This parameter holds information on the actual operating status of the frequency inverter, such as fault, maintenance, and reason for switch-on inhibit.
<b>P701</b>	Last fault	This parameter holds information on the frequency inverter's last faults.
<b>P737</b>	Usage rate brakes.	This parameter holds information on the actual usage degree of the brake chopper or the actual utilisation of the braking resistor in generator mode. <ul style="list-style-type: none"> <li>• Depending on parameter settings P556 and P557.</li> <li>• If both are correctly set, the resistance is displayed.</li> </ul>

Refer to the frequency inverter manual for details  "Further documentation and software [www.nord.com](http://www.nord.com)".

## Error messages

Error messages from the braking resistor - the current or archived message for the last fault - can be read out from the information parameter Current Fault P700 and the Last Fault P701 in the error memory of the frequency inverter.

Error (E030/E050)	Meaning	Remarks
<b>3.1</b>	I <sup>2</sup> t overcurrent limit	Brake chopper: I <sup>2</sup> t limit has been triggered, 1.5x value for 60 s reached (  P556, P557) <ul style="list-style-type: none"> <li>• Avoid overcurrent in braking resistor</li> </ul>
<b>5.0</b>	Overvoltage Ud	Link circuit voltage too high <ul style="list-style-type: none"> <li>• Check the function of the braking resistor (cable break)</li> <li>• Resistance of connected braking resistor too high</li> </ul>

Refer to the frequency inverter manual for details  "Further documentation and software [www.nord.com](http://www.nord.com)".

**Connection diagram**

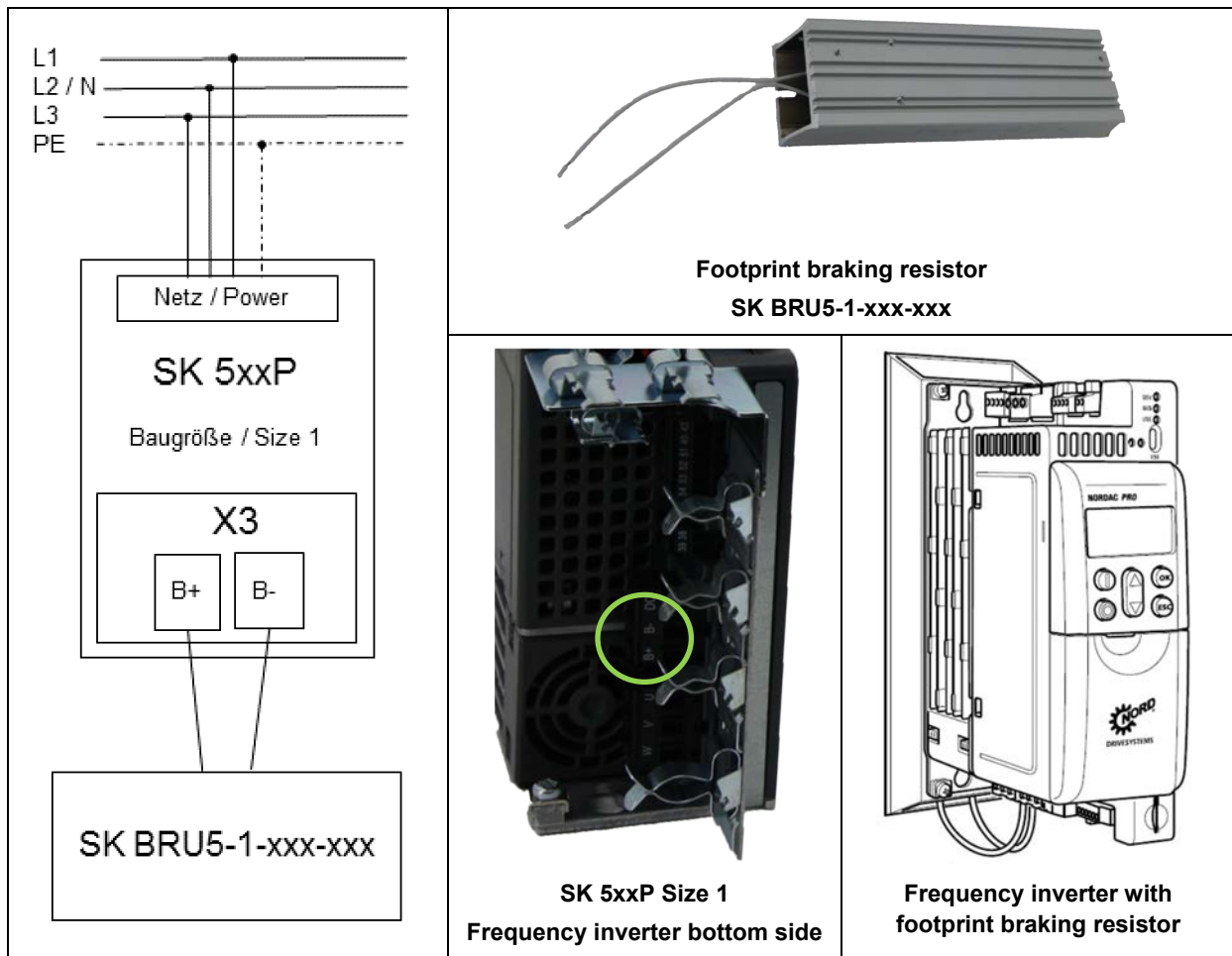

Further documentation and software [www.nord.com](http://www.nord.com)

Document	Designation
<a href="#">BU_0600</a>	Frequency inverter manual SK 500P – SK 550P

Document	Designation
<a href="#">F3060_E3000</a>	Flyer NORDAC PRO SK 500P

# GETRIEBEBAU NORD

Member of the NORD DRIVESYSTEMS Group

Getriebebau NORD GmbH & Co. KG  
Getriebebau-Nord-Straße 1 • 22941 Bargteheide, Germany • www.nord.com



## SK BRU5-2-220-200

Footprint braking resistor for connection  
to a NORDAC PRO SK 500P

Part number: 275 299 205



It only is allowed for qualified electricians to install and commission the module. An electrician is a person who, because of their technical training and experience, has sufficient knowledge relating to

- switching on, switching off, isolating, earthing and marking power circuits and devices,
- proper maintenance and use of protective devices in accordance with defined safety standards.

### DANGER!

#### Danger of electric shock

The frequency inverter continues to carry hazardous voltages for up to 5 minutes after it was switched off.

- Work must not be carried out unless the device has been disconnected from the voltage and at least 5 minutes have elapsed since the mains was switched off!

### CAUTION

#### Danger of burns

The module and all other metal components can heat up to temperatures above 70 °C.

- Sufficient cooling time must be allowed for when working on the components in order to avoid injuries (local burns) to parts of the body coming into contact with the components.
- In order to avoid damage to neighbouring objects, sufficient clearance must be maintained during installation.

### NOTICE

#### Validity of this document

This document is only valid in combination with the operating instructions for the relevant frequency inverter. Safe commissioning of this module and the frequency inverter depends on the availability of this information.

Technical Information / Datasheet	SK BRU5-2-220-200			
Brake resistor	275299205	1.0	0821	en

**Scope of delivery**

Module		
1 x	<b>Bottom-mounted braking resistor</b>	SK BRU5-2-...
2 x	<b>Fastening screws</b>	M4 x 12 (in the accessories kit)



**Field of use**

Dynamic braking (frequency lowering) of a three-phase motor via a frequency inverter results in generator braking energy that – depending on the particular application – is dissipated by a braking resistor. This excess energy is converted into heat.

The footprint braking resistor is intended for use with the NORDAC *PRO* SK 500P device series.



Similar to illustration

**Technical Data**
*Electrical data*

<b>Number of wires</b>		2
<b>Resistance</b>	Ω	220
<b>Max. continuous power P<sub>n</sub></b>	W	200
<b>Max. pulse energy capacity 1)</b>	kJ	4.5

<b>Short-time power P<sub>max 2)</sub></b>		
for 1.2 s	kW	3.0
<b>Rated power P</b>	W	≤ 150

<sup>1)</sup> The stated value applies to a single use < 1 s at an ambient temperature of 40°C.

<sup>2)</sup> The stated value applies to a single use within 120 s.

*General*

<b>Temperature range</b>	°C	-10 ... 40 (100% ED/S1) -10 ... 50 (70% ED/S3)
<b>Tightening torque</b> Screws	Nm	1.1 – 1.5
<b>Weight</b>	kg	≈ 0.49

<b>Approvals</b>	CE, RoHS, UL recognition
<b>Protection class</b>	IP65
<b>Mounting</b> Screws Screws <sup>1)</sup>	2 x M4 x 12 (SK 5xxP) 2 x M5 x 8 (mounting surface)

<sup>1)</sup> Not included in the scope of delivery

*Dimensions*

<b>Overall dimensions (W x H x D)</b>	mm	65 x 35 x 275
---------------------------------------	----	---------------

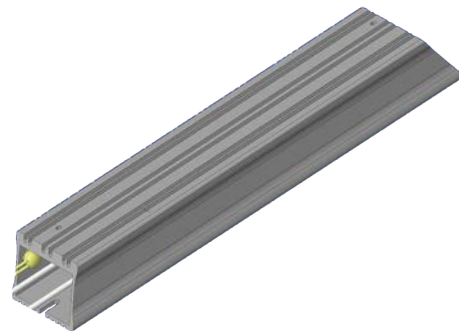
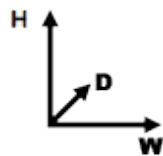
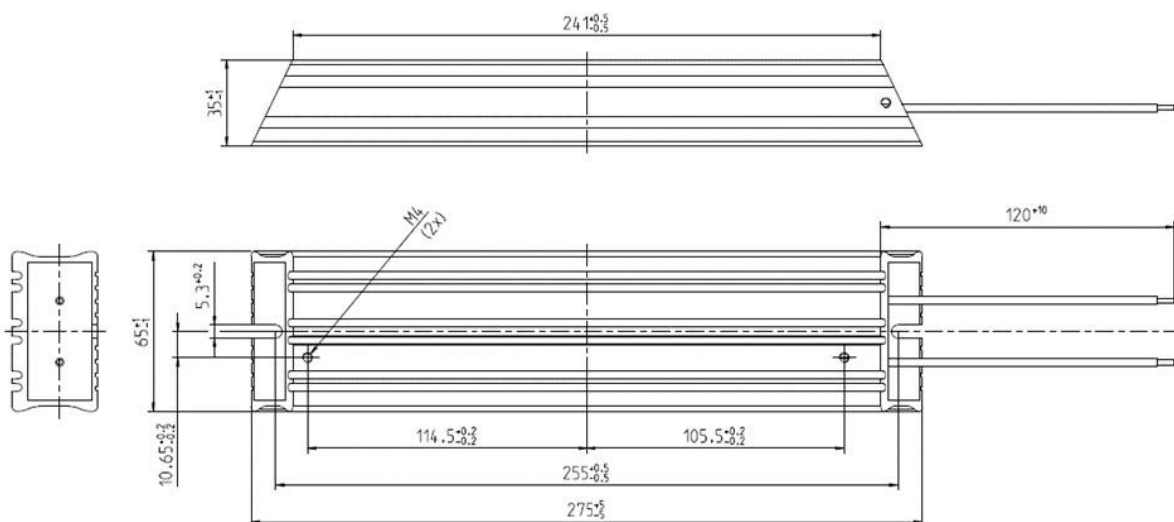
*Dimensioning drawing*

*Connections*



Designation	B+	B-
Cross section / type	AWG 18	
Wire colour	White	

**Assignment to frequency inverters**

** Information**

Overview in the manual

The footprint braking resistors provided by the NORD DRIVESYSTEMS Group are directly tailored to the individual frequency inverters.

For detailed information, please refer to the frequency inverter manual  "Further documentation and software [www.nord.com](http://www.nord.com)", chapter  braking resistor (BR).

**Maintenance information**

In order to ensure the dissipation of heat energy from the resistor body and the connecting cables, these must be free from dirt during operation.

Due to temperature development on the resistor's surface, deposits of flammable material must be avoided in order to avoid ignition.

Cleaning of the resistor must be carried out with a dry duster on a regular basis when the resistor has completely cooled down. The use of detergents for cleaning the resistor is generally not permitted.

For detailed information, please refer to the Maintenance and service information chapter in the BU 0600 manual, see  "Further documentation and software [www.nord.com](http://www.nord.com)".

** CAUTION**

**Overload**

In case of overload, the braking resistor would be subject to significantly increased heat. Depending on the overload degree, this may lead to overheating which permanently damages or even destroys the braking resistor. As this can be accompanied by risk of fire for components in the vicinity of the resistor, such overloads must be detected and avoided at an early stage.

- Use optional temperature switch
- Monitoring via parameter settings

### Temperature monitoring

For connection to the frequency inverter, a temperature switch (bi-metal) is optionally available in two versions for temperature monitoring of the footprint braking resistor. The trigger characteristic selection depends on the installation position / mounting of the braking resistor.

#### Installation in the vicinity of the frequency inverter



Nominal temperature of 180°C  
Part No. 275991100

#### Direct installation below the frequency inverter

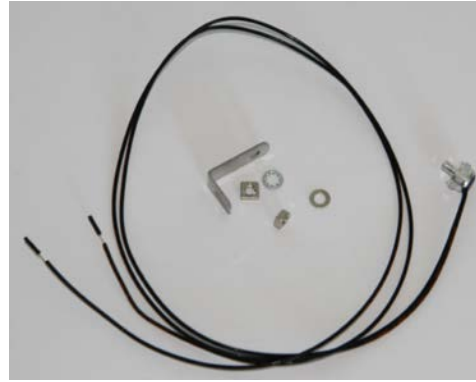

Nominal temperature of 100°C  
Part No. 275991200

### Information

The enclosed temperature switch fastening material is not required for mounting at the SK 5xxP frequency inverter.

### NOTICE

#### Impermissible heating

If the footprint braking resistor is mounted directly below the frequency inverter, a temperature switch with a nominal switch-off temperature of 100°C (Part No. 275991200) must be used. This is necessary to prevent impermissible heating of the frequency inverter.

- Failure to observe this may result in damage to the cooling system of the frequency inverter (fan).

### Technical Data

#### General

<b>Switching temperature</b>	°C	100 ± 5 180 ± 5
<b>Tightening torque</b> Bimetallic switch	Nm	1.8 – 2.0
<b>Weight</b>	kg	≈ 0.05

<b>Approvals</b>	CE, RoHS, UL	
<b>Protection class</b>	IP40	
<b>Mounting</b>		
Threads	M4	
Wrench size	10	

#### Electrical data

<b>Number of wires</b>		2
<b>Voltage</b>	V	250 AC 24 DC

<b>Switching cycles</b>		10000
<b>Current AC</b>	A	2.5 <sup>1)</sup> / 1.6 <sup>2)</sup>
<b>DC</b>	A	2.0

<sup>1)</sup> Stated value is  $\cos \varphi = 1$ .

<sup>2)</sup> Stated value is  $\cos \varphi = 0.6$ .

Brake resistor – SK BRU5-2-220-200

*Dimensions*

<b>Overall dimensions (W x H x D)</b>	mm	11 x 12 x 10
<b>Mounting (L)</b> M4 thread	mm	5
<b>Cable / line</b> Wire length	mm	50
Wire end sleeve	mm	10

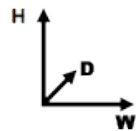

*Dimension drawing*

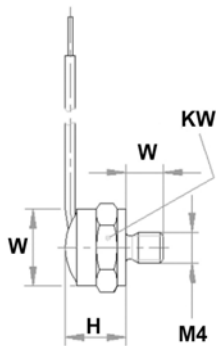





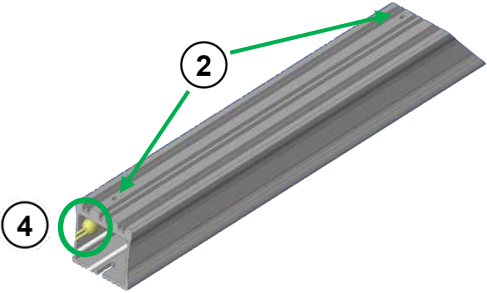
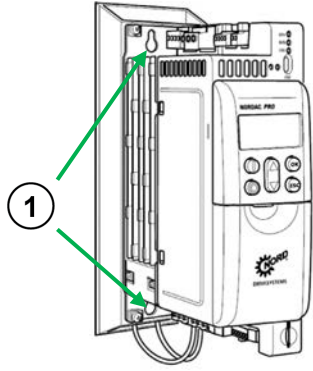

**Installation**

<b>Installation location</b>	Direct mounting or in the vicinity of the centralised NORDAC <i>PRO</i> frequency inverter. <ul style="list-style-type: none"> <li>• Below the frequency inverter</li> <li>• In the vicinity of the SK 5xxP within the control cabinet</li> </ul>
<b>Mounting position</b>	Lying flat on vertical mounting surfaces.
<b>Mounting</b>	With screw fasteners <ul style="list-style-type: none"> <li>• Screws for mounting are partially included in the scope of delivery</li> </ul>

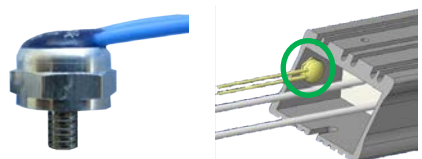
**Installation steps**

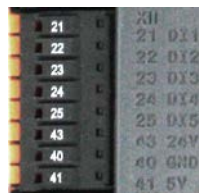
1.	<p>Direct installation below the frequency inverter Correctly mount the frequency inverter with the 2 provided fastening screws (M4 x 12) on the braking resistor.</p> <ul style="list-style-type: none"> <li>• ① For frequency inverter on ② braking resistor</li> <li>• ③ Braking resistor on mounting surface</li> </ul>  <p>Installation in the vicinity of the frequency inverter Correctly mount the braking resistor on the wall or the mounting surface close to the frequency inverter in horizontal position with the 2 fastening screws which are provided.</p> <ul style="list-style-type: none"> <li>• ① For frequency inverter on mounting surface</li> <li>• ③ Braking resistor on mounting surface</li> </ul>	 <p>Similar to illustration</p>
		
2.	<p>Installation of optional temperature monitoring ④ Install temperature switch (Part No. 275991100 or 275991200) on the braking resistor.</p> <ul style="list-style-type: none"> <li>• Vertical mounting primarily on the inside of the aluminium profile</li> <li>• Screw thread into the mounting hole</li> <li>• Fasten (M6) with open-ended spanner (SW10)</li> </ul>	
3.	<p>Connection to the frequency inverter Connect wires of the braking resistor at the bottom of the frequency inverter to the terminal block X3.</p> <p>Wire 1      B- Wire 2      B+</p> <p>Comply with specified tightening torques (see  Technical Data – General).</p> <p>Connect wires of the optional temperature switch at the front side of the frequency inverter to the terminal block X11.</p> <p>Wire 1      Digital input Wire 2      Voltage supply</p>	 

## Information

In order to use the signal from the temperature switch it must be connected to a free digital input of the frequency inverter and, for example, parameterised with the function "Voltage block" or "Quick stop".

Switching power of the normally closed contact:

- 2 A at 24 V DC
- 2 A / 230 V AC

For detailed information, please refer to the frequency inverter manual  "Further documentation and software [www.nord.com](http://www.nord.com)".

## Parameter

For optimum operation of the braking resistor, the following frequency inverter parameters need to be changed.

Parameter	Meaning	Remarks
<b>P556</b>	Braking resistor	Value of the braking resistor for calculation of the maximum brake power in order to protect the resistor. <ul style="list-style-type: none"> <li>• Error I<sup>2</sup>t limit (E003.1) is triggered. For further details, see  in P737.</li> </ul>
<b>P557</b>	Brake resistor type	Continuous power (nominal power) of the resistor, to display the actual utilisation in P737. For a correctly calculated value, the correct value must be entered into P556 and P557. <ul style="list-style-type: none"> <li>• 0.00 = Off, monitoring disabled</li> </ul>
<b>P700</b>	Actual operating status	This parameter holds information on the actual operating status of the frequency inverter, such as fault, maintenance, and reason for switch-on inhibit.
<b>P701</b>	Last fault	This parameter holds information on the frequency inverter's last faults.
<b>P737</b>	Usage rate brakes.	This parameter holds information on the actual usage degree of the brake chopper or the actual utilisation of the braking resistor in generator mode. <ul style="list-style-type: none"> <li>• Depending on parameter settings P556 and P557.</li> <li>• If both are correctly set, the resistance is displayed.</li> </ul>

Refer to the frequency inverter manual for details  "Further documentation and software [www.nord.com](http://www.nord.com)".





## Error messages

Error messages from the braking resistor - the current or archived message for the last fault - can be read out from the information parameter Current Fault P700 and the Last Fault P701 in the error memory of the frequency inverter.

Error (E030/E050)	Meaning	Remarks
<b>3.1</b>	I <sup>2</sup> t overcurrent limit	Brake chopper: I <sup>2</sup> t limit has been triggered, 1.5x value for 60 s reached (  P556, P557) <ul style="list-style-type: none"> <li>• Avoid overcurrent in braking resistor</li> </ul>
<b>5.0</b>	Overvoltage Ud	Link circuit voltage too high <ul style="list-style-type: none"> <li>• Check the function of the braking resistor (cable break)</li> <li>• Resistance of connected braking resistor too high</li> </ul>

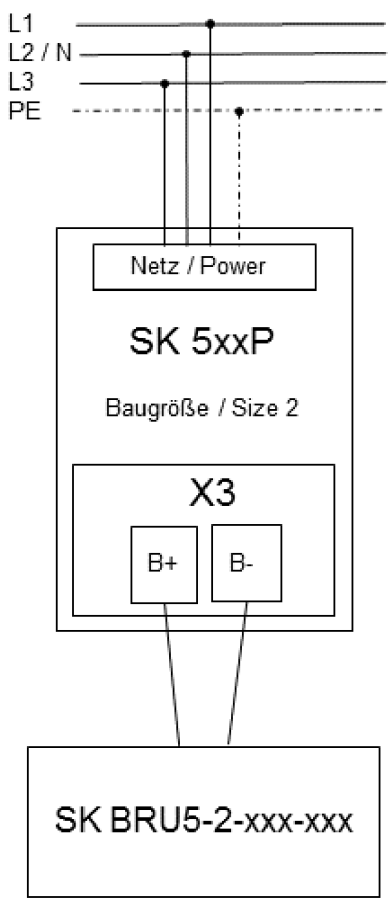
Refer to the frequency inverter manual for details  "Further documentation and software [www.nord.com](http://www.nord.com)".

**Connection diagram**

 <p style="text-align: center;">Netz / Power</p> <p style="text-align: center;"><b>SK 5xxP</b></p> <p style="text-align: center;">Baugröße / Size 2</p> <p style="text-align: center;">X3</p> <p style="text-align: center;">B+    B-</p> <p style="text-align: center;">SK BRU5-2-xxx-xxx</p>	 <p style="text-align: center;"><b>Footprint braking resistor</b> <b>SK BRU5-2-xxx-xxx</b></p>
 <p style="text-align: center;"><b>SK 5xxP Size 2</b> <b>Frequency inverter bottom side</b></p>	 <p style="text-align: center;">Similar to illustration</p> <p style="text-align: center;"><b>Frequency inverter with</b> <b>footprint braking resistor</b></p>

Further documentation and software [www.nord.com](http://www.nord.com)

Document	Designation
<a href="#">BU_0600</a>	Frequency inverter manual SK 500P – SK 550P

Document	Designation
<a href="#">F3060_E3000</a>	Flyer NORDAC PRO SK 500P

# GETRIEBEBAU NORD

Member of the NORD DRIVESYSTEMS Group

Getriebebau NORD GmbH & Co. KG

Getriebebau-Nord-Straße 1 • 22941 Bargteheide, Germany • www.nord.com



## SK BRU5-2-075-200

Part number: 275 299 210

Footprint braking resistor for connection  
to a NORDAC PRO SK 500P



It only is allowed for qualified electricians to install and commission the module. An electrician is a person who, because of their technical training and experience, has sufficient knowledge relating to

- switching on, switching off, isolating, earthing and marking power circuits and devices,
- proper maintenance and use of protective devices in accordance with defined safety standards.

### **! DANGER!**

#### **Danger of electric shock**

The frequency inverter continues to carry hazardous voltages for up to 5 minutes after it was switched off.

- Work must not be carried out unless the device has been disconnected from the voltage and at least 5 minutes have elapsed since the mains was switched off!

### **! CAUTION**

#### **Danger of burns**

The module and all other metal components can heat up to temperatures above 70 °C.

- Sufficient cooling time must be allowed for when working on the components in order to avoid injuries (local burns) to parts of the body coming into contact with the components.
- In order to avoid damage to neighbouring objects, sufficient clearance must be maintained during installation.

### **NOTICE**

#### **Validity of this document**

This document is only valid in combination with the operating instructions for the relevant frequency inverter. Safe commissioning of this module and the frequency inverter depends on the availability of this information.

Technical Information / Datasheet	SK BRU5-2-075-200			
Brake resistor	275299210	1.0	0821	en

**Scope of delivery**

Module		
1 x	<b>Bottom-mounted braking resistor</b>	SK BRU5-2-...
2 x	<b>Fastening screws</b>	M4 x 12 (in the accessories kit)



**Field of use**

Dynamic braking (frequency lowering) of a three-phase motor via a frequency inverter results in generator braking energy that – depending on the particular application – is dissipated by a braking resistor. This excess energy is converted into heat.

The footprint braking resistor is intended for use with the NORDAC *PRO* SK 500P device series.



Similar to illustration

**Technical Data**
*Electrical data*

<b>Number of wires</b>		2
<b>Resistance</b>	Ω	75
<b>Max. continuous power P<sub>n</sub></b>	W	200
<b>Max. pulse energy capacity 1)</b>	kJ	8.0

<b>Short-time power P<sub>max 2)</sub></b>		
for 1.2 s	kW	3.0
<b>Rated power P</b>	W	≤ 150

<sup>1)</sup> The stated value applies to a single use < 1 s at an ambient temperature of 40°C.

<sup>2)</sup> The stated value applies to a single use within 120 s.

*General*

<b>Temperature range</b>	°C	-10 ... 40 (100% ED/S1) -10 ... 50 (70% ED/S3)
<b>Tightening torque</b> Screws	Nm	1.1 – 1.5
<b>Weight</b>	kg	≈ 0.49

<b>Approvals</b>	CE, RoHS, UL recognition
<b>Protection class</b>	IP65
<b>Mounting</b> Screws Screws <sup>1)</sup>	2 x M4 x 12 (SK 5xxP) 2 x M5 x 8 (mounting surface)

<sup>1)</sup> Not included in the scope of delivery

*Dimensions*

<b>Overall dimensions (W x H x D)</b>	mm	65 x 35 x 275
---------------------------------------	----	---------------

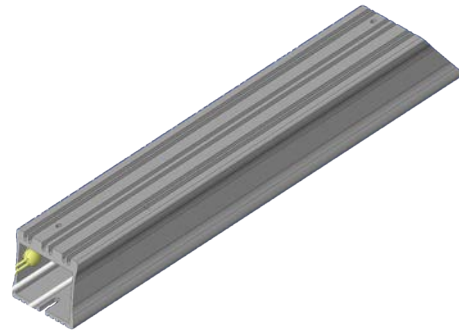
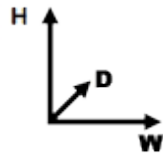
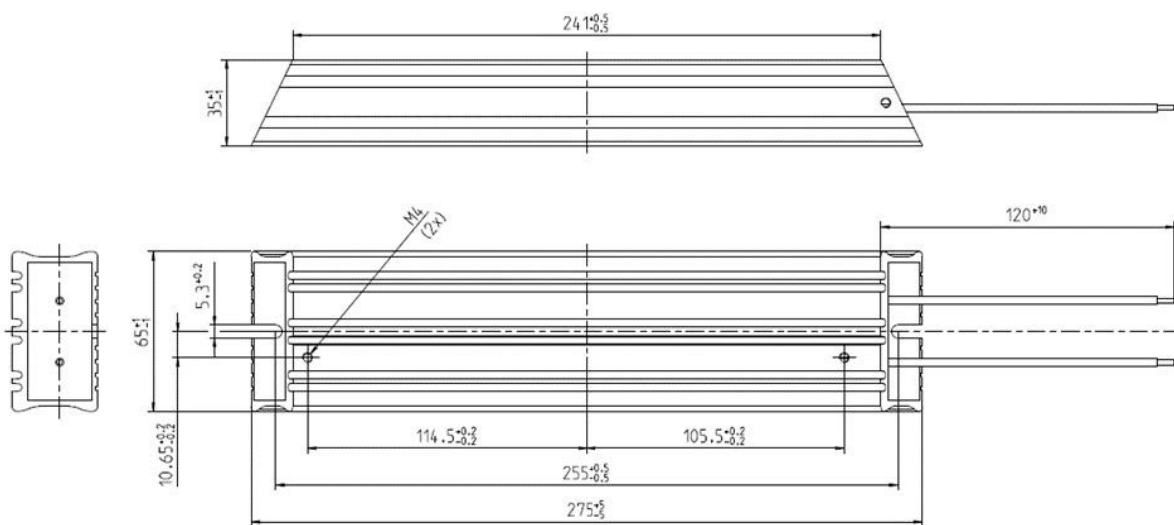
*Dimensioning drawing*

### Connections

Designation	B+	B-
Cross section / type	AWG 18	
Wire colour	White	



### Assignment to frequency inverters

---

#### Information

Overview in the manual

The footprint braking resistors provided by the NORD DRIVESYSTEMS Group are directly tailored to the individual frequency inverters.

For detailed information, please refer to the frequency inverter manual  "Further documentation and software [www.nord.com](http://www.nord.com)", chapter  braking resistor (BR).

#### Maintenance information

In order to ensure the dissipation of heat energy from the resistor body and the connecting cables, these must be free from dirt during operation.

Due to temperature development on the resistor's surface, deposits of flammable material must be avoided in order to avoid ignition.

Cleaning of the resistor must be carried out with a dry duster on a regular basis when the resistor has completely cooled down. The use of detergents for cleaning the resistor is generally not permitted.

For detailed information, please refer to the Maintenance and service information chapter in the BU 0600 manual, see  "Further documentation and software [www.nord.com](http://www.nord.com)".

#### CAUTION

#### Overload

In case of overload, the braking resistor would be subject to significantly increased heat. Depending on the overload degree, this may lead to overheating which permanently damages or even destroys the braking resistor. As this can be accompanied by risk of fire for components in the vicinity of the resistor, such overloads must be detected and avoided at an early stage.

- Use optional temperature switch
  - Monitoring via parameter settings
-

## Temperature monitoring

For connection to the frequency inverter, a temperature switch (bi-metal) is optionally available in two versions for temperature monitoring of the footprint braking resistor. The trigger characteristic selection depends on the installation position / mounting of the braking resistor.

### Installation in the vicinity of the frequency inverter



Nominal temperature of 180°C  
Part No. 275991100

### Direct installation below the frequency inverter

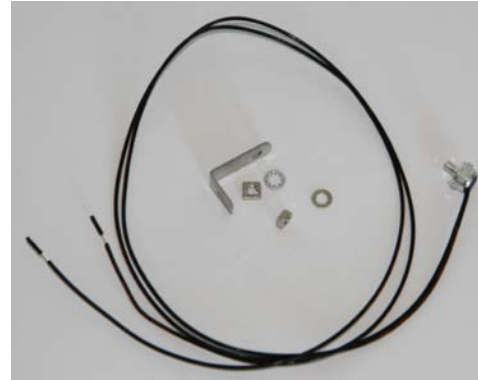

Nominal temperature of 100°C  
Part No. 275991200

## Information

The enclosed temperature switch fastening material is not required for mounting at the SK 5xxP frequency inverter.

## NOTICE

### Impermissible heating

If the footprint braking resistor is mounted directly below the frequency inverter, a temperature switch with a nominal switch-off temperature of 100°C (Part No. 275991200) must be used. This is necessary to prevent impermissible heating of the frequency inverter.

- Failure to observe this may result in damage to the cooling system of the frequency inverter (fan).

## Technical Data

### General

<b>Switching temperature</b>	°C	100 ± 5 180 ± 5
<b>Tightening torque</b> Bimetallic switch	Nm	1.8 – 2.0
<b>Weight</b>	kg	≈ 0.05

<b>Approvals</b>	CE, RoHS, UL		
<b>Protection class</b>	IP40		
<b>Mounting</b>			
Threads	M4		
Wrench size	10		

### Electrical data

<b>Number of wires</b>		2
<b>Voltage</b>	V	250 AC 24 DC

<b>Switching cycles</b>		10000
<b>Current AC</b>	A	2.5 <sup>1)</sup> / 1.6 <sup>2)</sup>
<b>DC</b>	A	2.0

<sup>1)</sup> Stated value is  $\cos \varphi = 1$ .

<sup>2)</sup> Stated value is  $\cos \varphi = 0.6$ .



*Dimensions*

<b>Overall dimensions (W x H x D)</b>	mm	11 x 12 x 10
<b>Mounting (L)</b> M4 thread	mm	5
<b>Cable / line</b> Wire length	mm	50
Wire end sleeve	mm	10

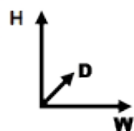



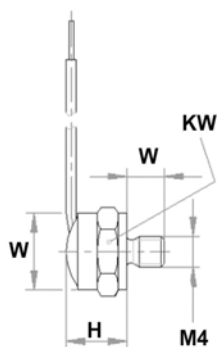

*Dimension drawing*

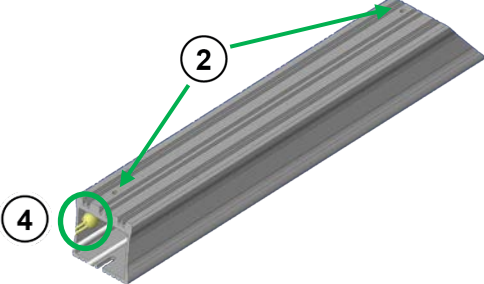
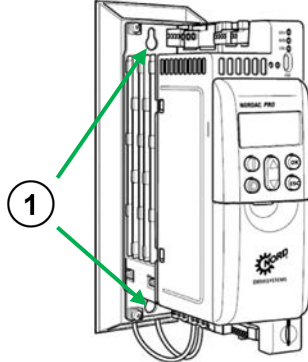
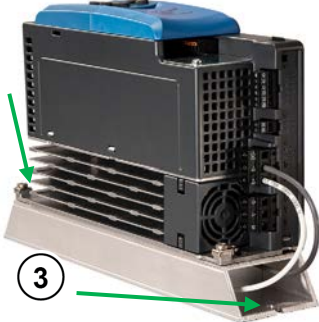
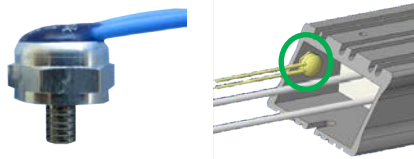

**Installation**

<b>Installation location</b>	Direct mounting or in the vicinity of the centralised NORDAC PRO frequency inverter. <ul style="list-style-type: none"> <li>• Below the frequency inverter</li> <li>• In the vicinity of the SK 5xxP within the control cabinet</li> </ul>
<b>Mounting position</b>	Lying flat on vertical mounting surfaces.
<b>Mounting</b>	With screw fasteners <ul style="list-style-type: none"> <li>• Screws for mounting are partially included in the scope of delivery</li> </ul>

**Installation steps**

<p>1.</p>	<p>Direct installation below the frequency inverter Correctly mount the frequency inverter with the 2 provided fastening screws (M4 x 12) on the braking resistor.</p> <ul style="list-style-type: none"> <li>• ① For frequency inverter on ② braking resistor</li> <li>• ③ Braking resistor on mounting surface</li> </ul>  <p>Installation in the vicinity of the frequency inverter Correctly mount the braking resistor on the wall or the mounting surface close to the frequency inverter in horizontal position with the 2 fastening screws which are provided.</p> <ul style="list-style-type: none"> <li>• ① For frequency inverter on mounting surface</li> <li>• ③ Braking resistor on mounting surface</li> </ul>	 <p>Similar to illustration</p>
		
<p>2.</p>	<p>Installation of optional temperature monitoring ④ Install temperature switch (Part No. 275991100 or 275991200) on the braking resistor.</p> <ul style="list-style-type: none"> <li>• Vertical mounting primarily on the inside of the aluminium profile</li> <li>• Screw thread into the mounting hole</li> <li>• Fasten (M6) with open-ended spanner (SW10)</li> </ul>	
<p>3.</p>	<p>Connection to the frequency inverter Connect wires of the braking resistor at the bottom of the frequency inverter to the terminal block X3.</p> <p>Wire 1      B- Wire 2      B+</p> <p>Comply with specified tightening torques (see  Technical Data – General).</p> <p>Connect wires of the optional temperature switch at the front side of the frequency inverter to the terminal block X11.</p> <p>Wire 1      Digital input Wire 2      Voltage supply</p>	 

## Information

In order to use the signal from the temperature switch it must be connected to a free digital input of the frequency inverter and, for example, parameterised with the function "Voltage block" or "Quick stop".

Switching power of the normally closed contact:

- 2 A at 24 V DC
- 2 A / 230 V AC

For detailed information, please refer to the frequency inverter manual  "Further documentation and software [www.nord.com](http://www.nord.com)".

## Parameter

For optimum operation of the braking resistor, the following frequency inverter parameters need to be changed.

Parameter	Meaning	Remarks
<b>P556</b>	Braking resistor	Value of the braking resistor for calculation of the maximum brake power in order to protect the resistor. <ul style="list-style-type: none"> <li>• Error I<sup>2</sup>t limit (E003.1) is triggered. For further details, see  in P737.</li> </ul>
<b>P557</b>	Brake resistor type	Continuous power (nominal power) of the resistor, to display the actual utilisation in P737. For a correctly calculated value, the correct value must be entered into P556 and P557. <ul style="list-style-type: none"> <li>• 0.00 = Off, monitoring disabled</li> </ul>
<b>P700</b>	Actual operating status	This parameter holds information on the actual operating status of the frequency inverter, such as fault, maintenance, and reason for switch-on inhibit.
<b>P701</b>	Last fault	This parameter holds information on the frequency inverter's last faults.
<b>P737</b>	Usage rate brakes.	This parameter holds information on the actual usage degree of the brake chopper or the actual utilisation of the braking resistor in generator mode. <ul style="list-style-type: none"> <li>• Depending on parameter settings P556 and P557.</li> <li>• If both are correctly set, the resistance is displayed.</li> </ul>

Refer to the frequency inverter manual for details  "Further documentation and software [www.nord.com](http://www.nord.com)".





## Error messages

Error messages from the braking resistor - the current or archived message for the last fault - can be read out from the information parameter Current Fault P700 and the Last Fault P701 in the error memory of the frequency inverter.

Error (E030/E050)	Meaning	Remarks
<b>3.1</b>	I <sup>2</sup> t overcurrent limit	Brake chopper: I <sup>2</sup> t limit has been triggered, 1.5x value for 60 s reached (  P556, P557) <ul style="list-style-type: none"> <li>• Avoid overcurrent in braking resistor</li> </ul>
<b>5.0</b>	Overvoltage Ud	Link circuit voltage too high <ul style="list-style-type: none"> <li>• Check the function of the braking resistor (cable break)</li> <li>• Resistance of connected braking resistor too high</li> </ul>

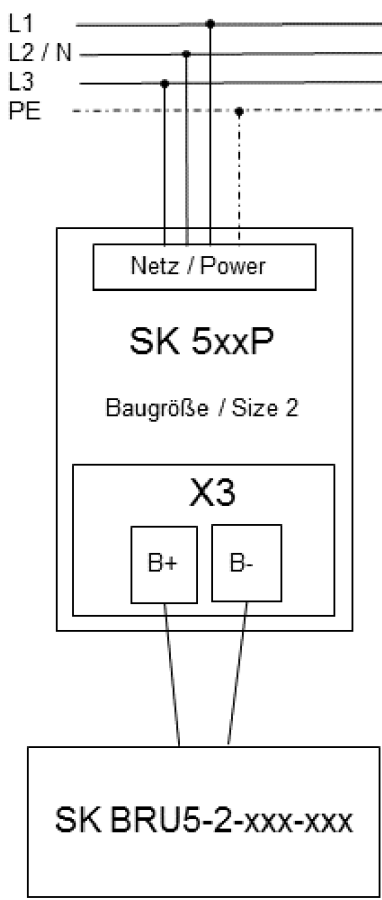
Refer to the frequency inverter manual for details  "Further documentation and software [www.nord.com](http://www.nord.com)".

**Connection diagram**

 <p style="text-align: center;">Netz / Power</p> <p style="text-align: center;"><b>SK 5xxP</b></p> <p style="text-align: center;">Baugröße / Size 2</p> <p style="text-align: center;">X3</p> <p style="text-align: center;">B+    B-</p> <p style="text-align: center;">SK BRU5-2-xxx-xxx</p>	 <p style="text-align: center;"><b>Footprint braking resistor</b> <b>SK BRU5-2-xxx-xxx</b></p>
 <p style="text-align: center;"><b>SK 5xxP Size 2</b> <b>Frequency inverter bottom side</b></p>	 <p style="text-align: center;">Similar to illustration</p> <p style="text-align: center;"><b>Frequency inverter with</b> <b>footprint braking resistor</b></p>

Further documentation and software [www.nord.com](http://www.nord.com)

Document	Designation
<a href="#">BU_0600</a>	Frequency inverter manual SK 500P – SK 550P

Document	Designation
<a href="#">F3060_E3000</a>	Flyer NORDAC PRO SK 500P

# GETRIEBEBAU NORD

Member of the NORD DRIVESYSTEMS Group



Getriebebau NORD GmbH & Co. KG  
Getriebebau-Nord-Straße 1 • 22941 Bargteheide, Germany • www.nord.com

## SK BRU5-3-100-300

Part number: 275 299 309

Footprint braking resistor for connection  
to a NORDAC PRO SK 500P



It only is allowed for qualified electricians to install and commission the module. An electrician is a person who, because of their technical training and experience, has sufficient knowledge relating to

- switching on, switching off, isolating, earthing and marking power circuits and devices,
- proper maintenance and use of protective devices in accordance with defined safety standards.

### DANGER!

#### Danger of electric shock

The frequency inverter continues to carry hazardous voltages for up to 5 minutes after it was switched off.

- Work must not be carried out unless the device has been disconnected from the voltage and at least 5 minutes have elapsed since the mains was switched off!

### CAUTION

#### Danger of burns

The module and all other metal components can heat up to temperatures above 70 °C.

- Sufficient cooling time must be allowed for when working on the components in order to avoid injuries (local burns) to parts of the body coming into contact with the components.
- In order to avoid damage to neighbouring objects, sufficient clearance must be maintained during installation.

### NOTICE

#### Validity of this document

This document is only valid in combination with the operating instructions for the relevant frequency inverter. Safe commissioning of this module and the frequency inverter depends on the availability of this information.

Technical Information / Datasheet	SK BRU5-3-100-300			
Brake resistor	275299309	1.0	0821	en

**Scope of delivery**

Module		
1 x	<b>Bottom-mounted braking resistor</b>	SK BRU5-3-...
4 x	<b>Fastening screws</b>	M4 x 12 (in the accessories kit)



**Field of use**

Dynamic braking (frequency lowering) of a three-phase motor via a frequency inverter results in generator braking energy that – depending on the particular application – is dissipated by a braking resistor. This excess energy is converted into heat.

The footprint braking resistor is intended for use with the NORDAC *PRO* SK 500P device series.



Similar to illustration

**Technical Data**
*Electrical data*

<b>Number of wires</b>		2
<b>Resistance</b>	Ω	100
<b>Max. continuous power P<sub>n</sub></b>	W	300
<b>Max. pulse energy capacity 1)</b>	kJ	13.0

<b>Short-time power P<sub>max 2)</sub></b>		
for 1.2 s	kW	4.5
<b>Rated power P</b>	W	≤ 300

<sup>1)</sup> The stated value applies to a single use < 1 s at an ambient temperature of 40°C.

<sup>2)</sup> The stated value applies to a single use within 120 s.

*General*

<b>Temperature range</b>	°C	-10 ... 40 (100% ED/S1) -10 ... 50 (70% ED/S3)
<b>Tightening torque</b> Screws	Nm	1.1 – 1.5
<b>Weight</b>	kg	≈ 0.65

<b>Approvals</b>	CE, RoHS, UL recognition
<b>Protection class</b>	IP65
<b>Mounting</b> Screws Screws <sup>1)</sup>	4 x M4 x 12 (SK 5xxP) 2 x M5 x 8 (mounting surface)

<sup>1)</sup> Not included in the scope of delivery

*Dimensions*

<b>Overall dimensions (W x H x D)</b>	mm	65 x 35 x 335
---------------------------------------	----	---------------

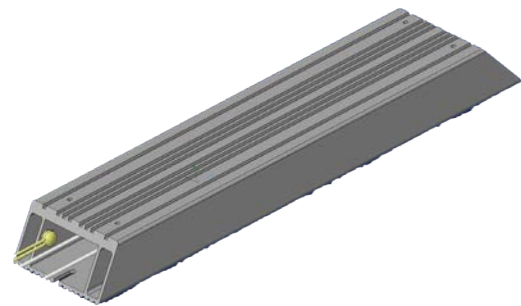
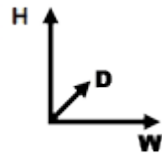
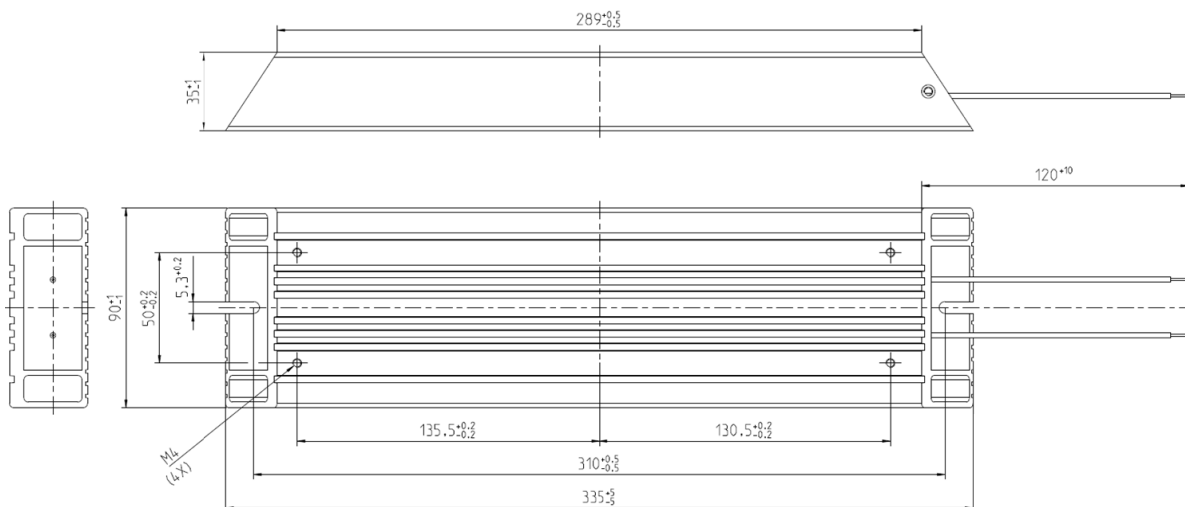
*Dimensioning drawing*

*Connections*



Designation	B+	B-
Cross section / type	AWG 18	
Wire colour	White	

**Assignment to frequency inverters**

** Information**

Overview in the manual

The footprint braking resistors provided by the NORD DRIVESYSTEMS Group are directly tailored to the individual frequency inverters.

For detailed information, please refer to the frequency inverter manual  "Further documentation and software [www.nord.com](http://www.nord.com)", chapter  braking resistor (BR).

**Maintenance information**

In order to ensure the dissipation of heat energy from the resistor body and the connecting cables, these must be free from dirt during operation.

Due to temperature development on the resistor's surface, deposits of flammable material must be avoided in order to avoid ignition.

Cleaning of the resistor must be carried out with a dry duster on a regular basis when the resistor has completely cooled down. The use of detergents for cleaning the resistor is generally not permitted.

For detailed information, please refer to the Maintenance and service information chapter in the BU 0600 manual, see  "Further documentation and software [www.nord.com](http://www.nord.com)".

** CAUTION**

**Overload**

In case of overload, the braking resistor would be subject to significantly increased heat. Depending on the overload degree, this may lead to overheating which permanently damages or even destroys the braking resistor. As this can be accompanied by risk of fire for components in the vicinity of the resistor, such overloads must be detected and avoided at an early stage.

- Use optional temperature switch
- Monitoring via parameter settings



## Temperature monitoring

For connection to the frequency inverter, a temperature switch (bi-metal) is optionally available in two versions for temperature monitoring of the footprint braking resistor. The trigger characteristic selection depends on the installation position / mounting of the braking resistor.

### Installation in the vicinity of the frequency inverter



Nominal temperature of 180°C  
Part No. 275991100

### Direct installation below the frequency inverter

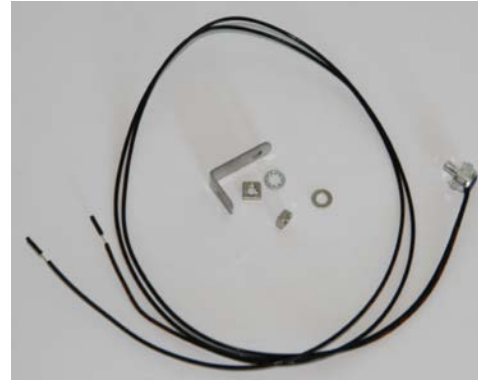

Nominal temperature of 100°C  
Part No. 275991200

## Information

The enclosed temperature switch fastening material is not required for mounting at the SK 5xxP frequency inverter.

## NOTICE

### Impermissible heating

If the footprint braking resistor is mounted directly below the frequency inverter, a temperature switch with a nominal switch-off temperature of 100°C (Part No. 275991200) must be used. This is necessary to prevent impermissible heating of the frequency inverter.

- Failure to observe this may result in damage to the cooling system of the frequency inverter (fan).

## Technical Data

### General

<b>Switching temperature</b>	°C	100 ± 5 180 ± 5
<b>Tightening torque</b> Bimetallic switch	Nm	1.8 – 2.0
<b>Weight</b>	kg	≈ 0.05

### Electrical data

<b>Number of wires</b>		2
<b>Voltage</b>	V	250 AC 24 DC

<b>Approvals</b>	CE, RoHS, UL	
<b>Protection class</b>	IP40	
<b>Mounting</b>		
Threads	M4	
Wrench size	10	

<b>Switching cycles</b>		10000
<b>Current AC</b>	A	2.5 <sup>1)</sup> / 1.6 <sup>2)</sup>
<b>DC</b>	A	2.0

<sup>1)</sup> Stated value is  $\cos \varphi = 1$ .

<sup>2)</sup> Stated value is  $\cos \varphi = 0.6$ .

Brake resistor – SK BRU5-3-100-300

*Dimensions*

<b>Overall dimensions (W x H x D)</b>	mm	11 x 12 x 10
<b>Mounting (L)</b> M4 thread	mm	5
<b>Cable / line</b> Wire length	mm	50
Wire end sleeve	mm	10

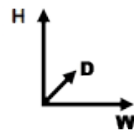

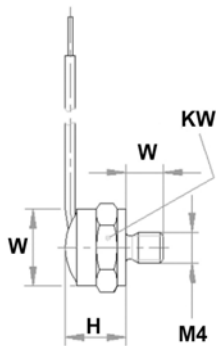

*Dimension drawing*



**Installation**

<b>Installation location</b>	Direct mounting or in the vicinity of the centralised NORDAC <i>PRO</i> frequency inverter. <ul style="list-style-type: none"> <li>• Below the frequency inverter</li> <li>• In the vicinity of the SK 5xxP within the control cabinet</li> </ul>
<b>Mounting position</b>	Lying flat on vertical mounting surfaces.
<b>Mounting</b>	With screw fasteners <ul style="list-style-type: none"> <li>• Screws for mounting are partially included in the scope of delivery</li> </ul>

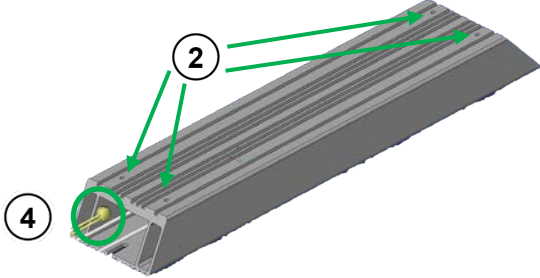
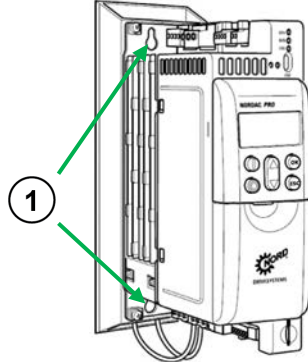
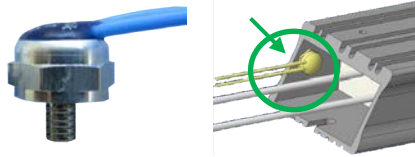
**Installation steps**

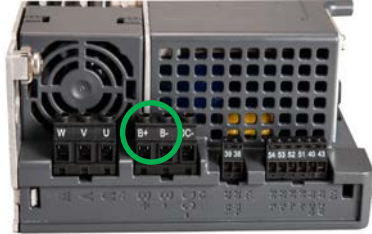
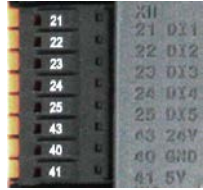
1.	<p>Direct installation below the frequency inverter                  Correctly mount the frequency inverter with the 4 provided fastening screws (M4 x 12) on the braking resistor.</p> <ul style="list-style-type: none"> <li>• ① For frequency inverter on ② braking resistor</li> <li>• ③ Braking resistor on mounting surface</li> </ul>  <p>Installation in the vicinity of the frequency inverter                  Correctly mount the braking resistor on the wall or the mounting surface close to the frequency inverter in horizontal position with the 2 fastening screws which are provided.</p> <ul style="list-style-type: none"> <li>• ① For frequency inverter on mounting surface</li> <li>• ③ Braking resistor on mounting surface</li> </ul>	 <p>Similar to illustration</p>
2.	<p>Installation of optional temperature monitoring                  ④ Install temperature switch (Part No. 275991100 or 275991200) on the braking resistor.</p> <ul style="list-style-type: none"> <li>• Vertical mounting on the outside of the aluminium profile</li> <li>• Screw thread into the mounting hole</li> <li>• Fasten (M6) with open-ended spanner (SW10)</li> </ul>	
3.	<p>Connection to the frequency inverter                  Connect wires of the braking resistor at the bottom of the frequency inverter to the terminal block X3.</p> <p>Wire 1      B-                  Wire 2      B+</p> <p>Comply with specified tightening torques (see  Technical Data – General).</p> <p>Connect wires of the optional temperature switch at the front side of the frequency inverter to the terminal block X11.</p> <p>Wire 1      Digital input                  Wire 2      Voltage supply</p>	 

## Information

In order to use the signal from the temperature switch it must be connected to a free digital input of the frequency inverter and, for example, parameterised with the function "Voltage block" or "Quick stop".

Switching power of the normally closed contact:

- 2 A at 24 V DC
- 2 A / 230 V AC

For detailed information, please refer to the frequency inverter manual  "Further documentation and software [www.nord.com](http://www.nord.com)".

## Parameter

For optimum operation of the braking resistor, the following frequency inverter parameters need to be changed.

Parameter	Meaning	Remarks
<b>P556</b>	Braking resistor	Value of the braking resistor for calculation of the maximum brake power in order to protect the resistor. <ul style="list-style-type: none"> <li>• Error I<sup>2</sup>t limit (E003.1) is triggered. For further details, see  in P737.</li> </ul>
<b>P557</b>	Brake resistor type	Continuous power (nominal power) of the resistor, to display the actual utilisation in P737. For a correctly calculated value, the correct value must be entered into P556 and P557. <ul style="list-style-type: none"> <li>• 0.00 = Off, monitoring disabled</li> </ul>
<b>P700</b>	Actual operating status	This parameter holds information on the actual operating status of the frequency inverter, such as fault, maintenance, and reason for switch-on inhibit.
<b>P701</b>	Last fault	This parameter holds information on the frequency inverter's last faults.
<b>P737</b>	Usage rate brakes.	This parameter holds information on the actual usage degree of the brake chopper or the actual utilisation of the braking resistor in generator mode. <ul style="list-style-type: none"> <li>• Depending on parameter settings P556 and P557.</li> <li>• If both are correctly set, the resistance is displayed.</li> </ul>

Refer to the frequency inverter manual for details  "Further documentation and software [www.nord.com](http://www.nord.com)".

## Error messages

Error messages from the braking resistor - the current or archived message for the last fault - can be read out from the information parameter Current Fault P700 and the Last Fault P701 in the error memory of the frequency inverter.

Error (E030/E050)	Meaning	Remarks
<b>3.1</b>	I <sup>2</sup> t overcurrent limit	Brake chopper: I <sup>2</sup> t limit has been triggered, 1.5x value for 60 s reached (  P556, P557) <ul style="list-style-type: none"> <li>• Avoid overcurrent in braking resistor</li> </ul>
<b>5.0</b>	Overvoltage Ud	Link circuit voltage too high <ul style="list-style-type: none"> <li>• Check the function of the braking resistor (cable break)</li> <li>• Resistance of connected braking resistor too high</li> </ul>

Refer to the frequency inverter manual for details  "Further documentation and software [www.nord.com](http://www.nord.com)".

Connection diagram

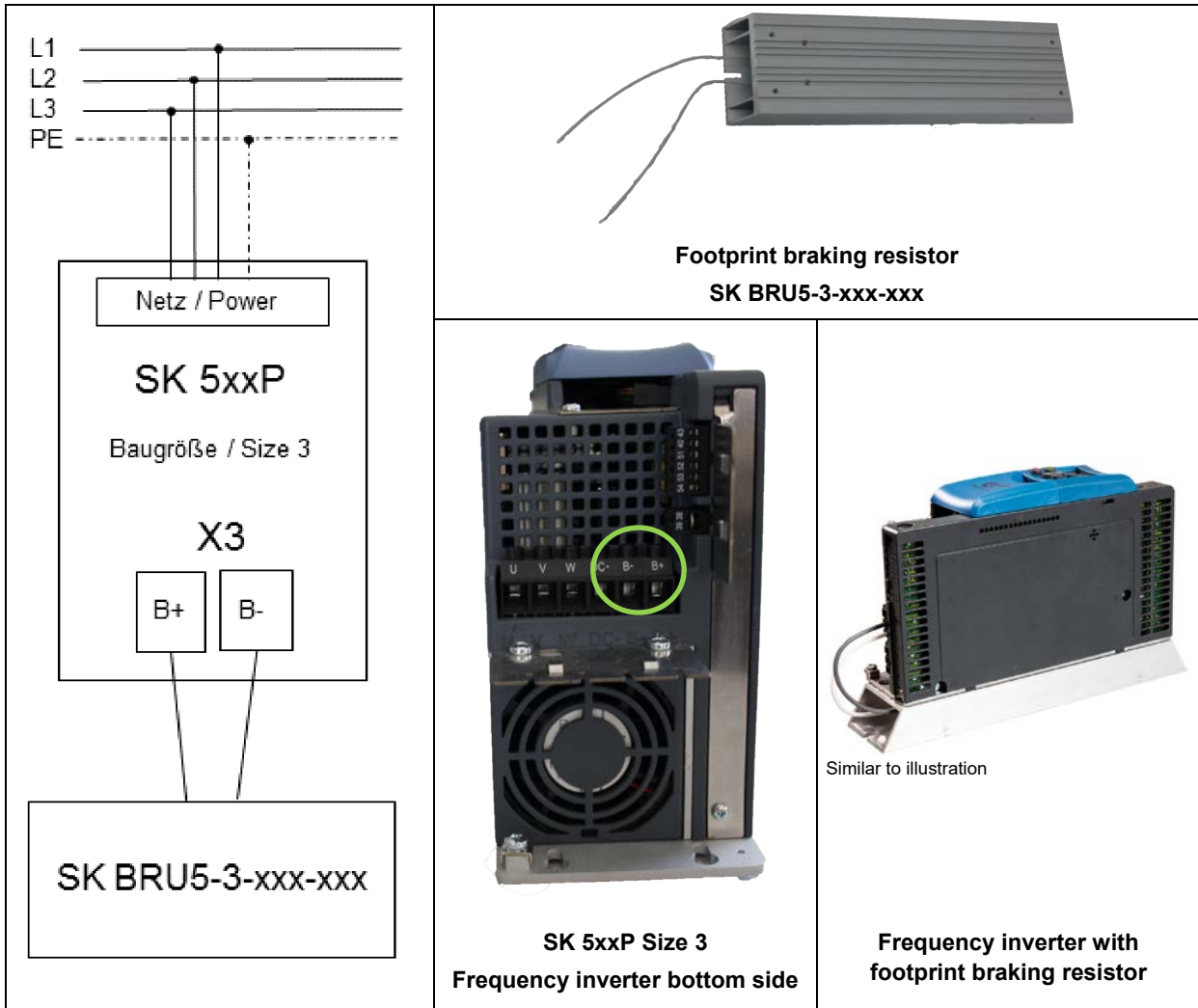

Further documentation and software [www.nord.com](http://www.nord.com)

Document	Designation
<a href="#">BU 0600</a>	Frequency inverter manual SK 500P – SK 550P

Document	Designation
<a href="#">F3060 E3000</a>	Flyer NORDAC PRO SK 500P

## SK BRU5-4-044-400

Footprint braking resistor for connection to a  
NORDAC PRO SK 500P

Part number: 275 299 512



It only is allowed for qualified electricians to install and commission the module. An electrician is a person who, because of their technical training and experience, has sufficient knowledge relating to

- switching on, switching off, isolating, earthing and marking power circuits and devices,
- proper maintenance and use of protective devices in accordance with defined safety standards.

### **DANGER!**

#### Danger of electric shock

The frequency inverter continues to carry hazardous voltages for up to 5 minutes after it was switched off.

- Work must not be carried out unless the device has been disconnected from the voltage and at least 5 minutes have elapsed since the mains was switched off!

### **CAUTION**

#### Danger of burns

The module and all other metal components can heat up to temperatures above 70 °C.

- Sufficient cooling time must be allowed for when working on the components in order to avoid injuries (local burns) to parts of the body coming into contact with the components.
- In order to avoid damage to neighbouring objects, sufficient clearance must be maintained during installation.

### **NOTICE**

#### Validity of this document

This document is only valid in combination with the operating instructions for the relevant frequency inverter. Safe commissioning of this module and the frequency inverter depends on the availability of this information.

Technical Information / Datasheet	SK BRU5-4-044-400			
Brake resistor	275299512	1.0	3621	en

**Scope of delivery**

Module		
1 x	<b>Bottom-mounted braking resistor</b>	SK BRU5-4-...
4 x	<b>Fastening screws</b>	M4 x 12 (in the accessories kit)

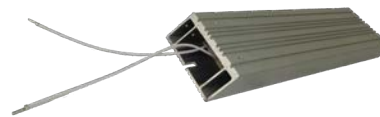

**Field of use**

Dynamic braking (frequency lowering) of a three-phase motor via a frequency inverter results in generator braking energy that – depending on the particular application – is dissipated by a braking resistor. This excess energy is converted into heat.

The footprint braking resistor is intended for use with the NORDAC *PRO* SK 500P device series.



**Technical Data**
*Electrical data*

<b>Number of wires</b>		2
<b>Resistance</b>	Ω	44
<b>Max. continuous power P<sub>n</sub></b>	W	400
<b>Max. pulse energy capacity 1)</b>	kJ	38.7

<b>Short-time power P<sub>max</sub> 2)</b>		
for 1.2 s	kW	7.5
<b>Rated power P</b>	W	≤ 400

<sup>1)</sup> The stated value applies to a single use < 1 s at an ambient temperature of 40°C.

<sup>2)</sup> The stated value applies to a single use within 120 s.

*General*

<b>Temperature range</b>	°C	-10 ... 40 (100% ED/S1) -10 ... 50 (70% ED/S3)
<b>Tightening torque</b> Screws	Nm	1.1–1.5
<b>Weight</b>	kg	≈ 1.02

<b>Approvals</b>	CE, RoHS, UL recognition
<b>Protection class</b>	IP65
<b>Mounting</b> Screws Screws <sup>1)</sup>	4 x M4 x 12 (SK 5xxP) 2 x M5 x 8 (mounting surface)

<sup>1)</sup> Not included in the scope of delivery

*Dimensions*

<b>Overall dimensions (W x H x D)</b>	mm	90 x 35 x 385
---------------------------------------	----	---------------

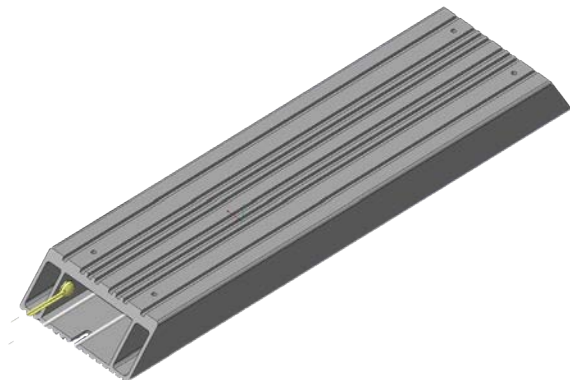
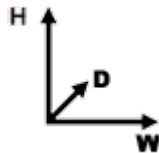
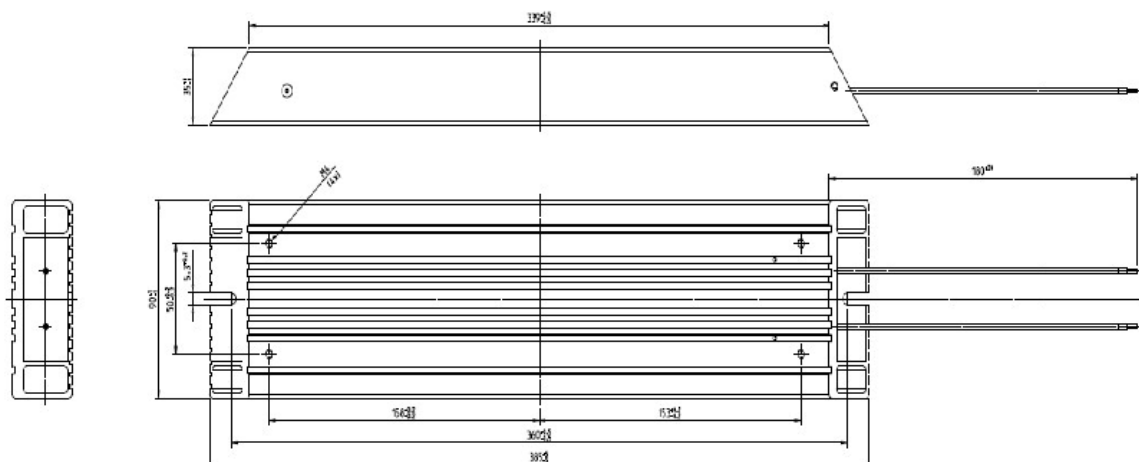
*Dimension drawing*



### Connections



Designation	B+	B-
Cross section / type	AWG 18	
Wire colour	White	

### Assignment to frequency inverters

#### Information

Overview in the manual

The footprint braking resistors provided by the NORD DRIVESYSTEMS Group are directly tailored to the individual frequency inverters.

For detailed information, please refer to the frequency inverter manual  "Further documentation and software [www.nord.com](http://www.nord.com)", chapter  braking resistor (BR).

#### Maintenance information

In order to ensure the dissipation of heat energy from the resistor body and the connecting cables, these must be free from dirt during operation.

Due to temperature development on the resistor's surface, deposits of flammable material must be avoided in order to avoid ignition.

Cleaning of the resistor must be carried out with a dry duster on a regular basis when the resistor has completely cooled down. The use of detergents for cleaning the resistor is generally not permitted.

For detailed information, please refer to the Maintenance and service information chapter in the BU 0600 manual, see  "Further documentation and software [www.nord.com](http://www.nord.com)".

#### CAUTION

##### Overload

In case of overload, the braking resistor would be subject to significantly increased heat. Depending on the overload degree, this may lead to overheating which permanently damages or even destroys the braking resistor. As this can be accompanied by risk of fire for components in the vicinity of the resistor, such overloads must be detected and avoided at an early stage.

- Use optional temperature switch
- Monitoring via parameter settings

## Temperature monitoring

For connection to the frequency inverter, a temperature switch (bi-metal) is optionally available in two versions for temperature monitoring of the footprint braking resistor. The trigger characteristic selection depends on the installation position / mounting of the braking resistor.

### Installation in the vicinity of the frequency inverter



Nominal temperature of 180°C  
Part No. 275991100

### Direct installation below the frequency inverter

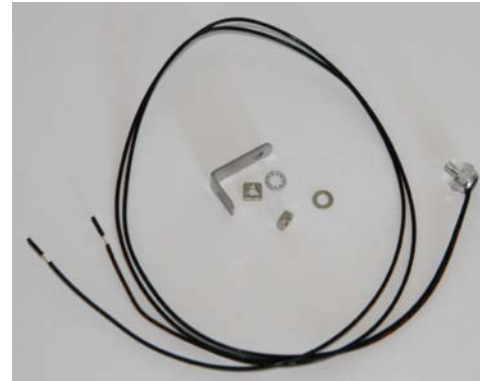

Nominal temperature of 100°C  
Part No. 275991200

## Information

The enclosed temperature switch fastening material is not required for mounting at the SK 5xxP frequency inverter.

## NOTICE

### Impermissible heating

If the footprint braking resistor is mounted directly below the frequency inverter, a temperature switch with a nominal switch-off temperature of 100°C (Part No. 275991200) must be used. This is necessary to prevent impermissible heating of the frequency inverter.

- Failure to observe this may result in damage to the cooling system of the frequency inverter (fan).

## Technical Data

### General

<b>Switching temperature</b>	°C	100 ± 5 180 ± 5
<b>Tightening torque</b> Bimetallic switch	Nm	1.8 – 2.0
<b>Weight</b>	kg	≈ 0.05

<b>Approvals</b>	CE, RoHS, UL	
<b>Protection class</b>	IP40	
<b>Mounting</b>		
Threads	M4	
Wrench size	10	

### Electrical data

<b>Number of wires</b>		2
<b>Voltage</b>	V	250 AC 24 DC

<b>Switching cycles</b>		10000	
<b>Current</b>	AC	A	2.5 <sup>1)</sup> / 1.6 <sup>2)</sup>
	DC	A	2.0

<sup>1)</sup> Stated value is  $\cos \varphi = 1$ .

<sup>2)</sup> Stated value is  $\cos \varphi = 0.6$ .

*Dimensions*

<b>Overall dimensions (W x H x D)</b>	mm	11 x 12 x 10
<b>Mounting (L)</b> M4 thread	mm	5
<b>Cable / line</b> Wire length	mm	50
Wire end sleeve	mm	10

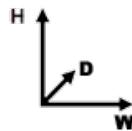

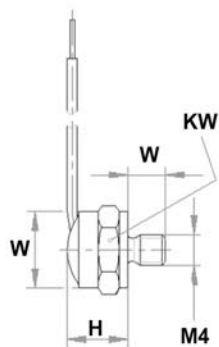

*Dimension drawing*



**Installation**

<b>Installation location</b>	Direct mounting or in the vicinity of the centralised NORDAC <i>PRO</i> frequency inverter. <ul style="list-style-type: none"> <li>• Below the frequency inverter</li> <li>• In the vicinity of the SK 5xxP within the control cabinet</li> </ul>
<b>Installation position</b>	Lying flat on vertical mounting surfaces.
<b>Mounting</b>	With screw fasteners <ul style="list-style-type: none"> <li>• Screws for mounting are partially included in the scope of delivery</li> </ul>

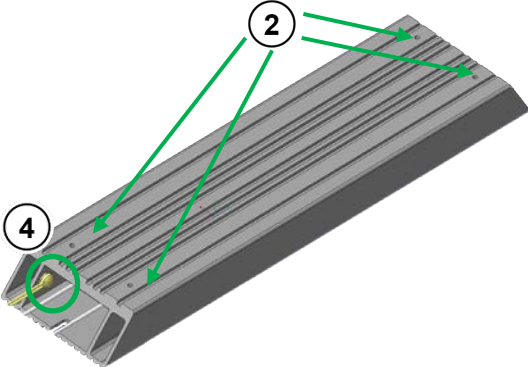
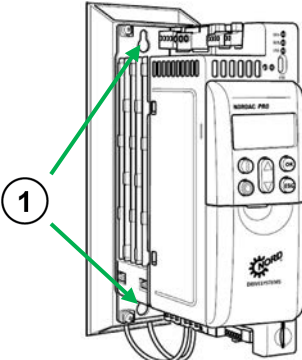
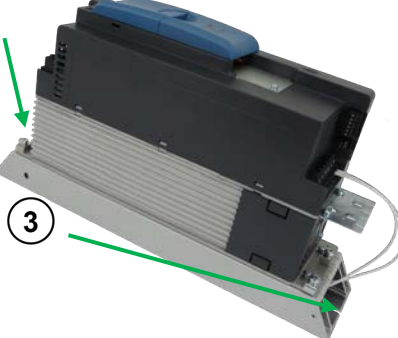
**Installation steps**

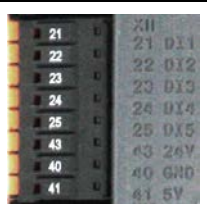
<p>1. Direct installation below the frequency inverter Correctly mount the frequency inverter with the 4 provided fastening screws (M4 x 12) on the braking resistor.</p> <ul style="list-style-type: none"> <li>• ① For frequency inverter on ② braking resistor</li> <li>• ③ Braking resistor on mounting surface</li> </ul>  <p>Installation in the vicinity of the frequency inverter Correctly mount the braking resistor on the wall or the mounting surface close to the frequency inverter in a horizontal position with the 2 fastening screws which are provided.</p> <ul style="list-style-type: none"> <li>• ① For frequency inverter on mounting surface</li> <li>• ③ Braking resistor on mounting surface</li> </ul>	 <p>Similar to illustration</p>
<p>2. Installation of optional temperature monitoring ④ Install temperature switch (Part No. 275991100 or 275991200) on the braking resistor.</p> <ul style="list-style-type: none"> <li>• Vertical mounting on the outside of the aluminium profile</li> <li>• Screw thread into the mounting hole</li> <li>• Fasten (M6) with open-ended spanner (SW10)</li> </ul>	
<p>3. Connection to the frequency inverter Connect the braking resistor wires on the underside of the frequency inverter to the terminal block X3.</p> <p>Wire 1      B- Wire 2      B+</p> <p>Comply with specified tightening torques (see  Technical Data – General).</p> <p>Connect the optional temperature switch wires on the front side of the frequency inverter to the terminal block X11.</p> <p>Wire 1      Digital input Wire 2      Voltage supply</p>	 

## Information

In order to use the signal from the temperature switch it must be connected to a free digital input of the frequency inverter and, for example, parameterised with the function "Voltage block" or "Quick stop".

Switching power of the normally closed contact:

- 2 A at 24 V DC
- 2 A / 230 V AC

For detailed information, please refer to the frequency inverter manual  "Further documentation and software [www.nord.com](http://www.nord.com)".

## Parameter

For optimum operation of the braking resistor, the following frequency inverter parameters need to be changed.

Parameter	Meaning	Remarks
P556	Braking resistor	Value of the braking resistor for calculation of the maximum brake power in order to protect the resistor. <ul style="list-style-type: none"> <li>• Error I<sup>2</sup>t limit (E003.1) is triggered. For further details, see  in P737.</li> </ul>
P557	Brake resistor type	Continuous power (nominal power) of the resistor, to display the actual utilisation in P737. For a correctly calculated value, the correct value must be entered into P556 and P557. <ul style="list-style-type: none"> <li>• 0.00 = Off, monitoring disabled</li> </ul>
P700	Actual operating status	This parameter holds information on the actual operating status of the frequency inverter, such as fault, maintenance, and reason for switch-on inhibit.
P701	Last fault	This parameter holds information on the frequency inverter's last faults.
P737	Usage rate brakes.	This parameter holds information on the actual usage degree of the brake chopper or the actual utilisation of the braking resistor in generator mode. <ul style="list-style-type: none"> <li>• Depending on parameter settings P556 and P557.</li> <li>• If both are correctly set, the resistance is displayed.</li> </ul>

Refer to the frequency inverter manual for details  "Further documentation and software [www.nord.com](http://www.nord.com)".

## Error messages

Error messages from the braking resistor - the current or archived message for the last fault - can be read out from the information parameter Current Fault P700 and the Last Fault P701 in the error memory of the frequency inverter.

Error (E030/E050)	Meaning	Remarks
3.1	I <sup>2</sup> t overcurrent limit	Brake chopper: I <sup>2</sup> t limit has been triggered, 1.5x value for 60 s reached (  P556, P557) <ul style="list-style-type: none"> <li>• Avoid overcurrent in braking resistor</li> </ul>
5.0	Overvoltage Ud	Link circuit voltage too high <ul style="list-style-type: none"> <li>• Check the function of the braking resistor (cable break)</li> <li>• Resistance of connected braking resistor too high</li> </ul>

Refer to the frequency inverter manual for details  "Further documentation and software [www.nord.com](http://www.nord.com)".

Connection diagram

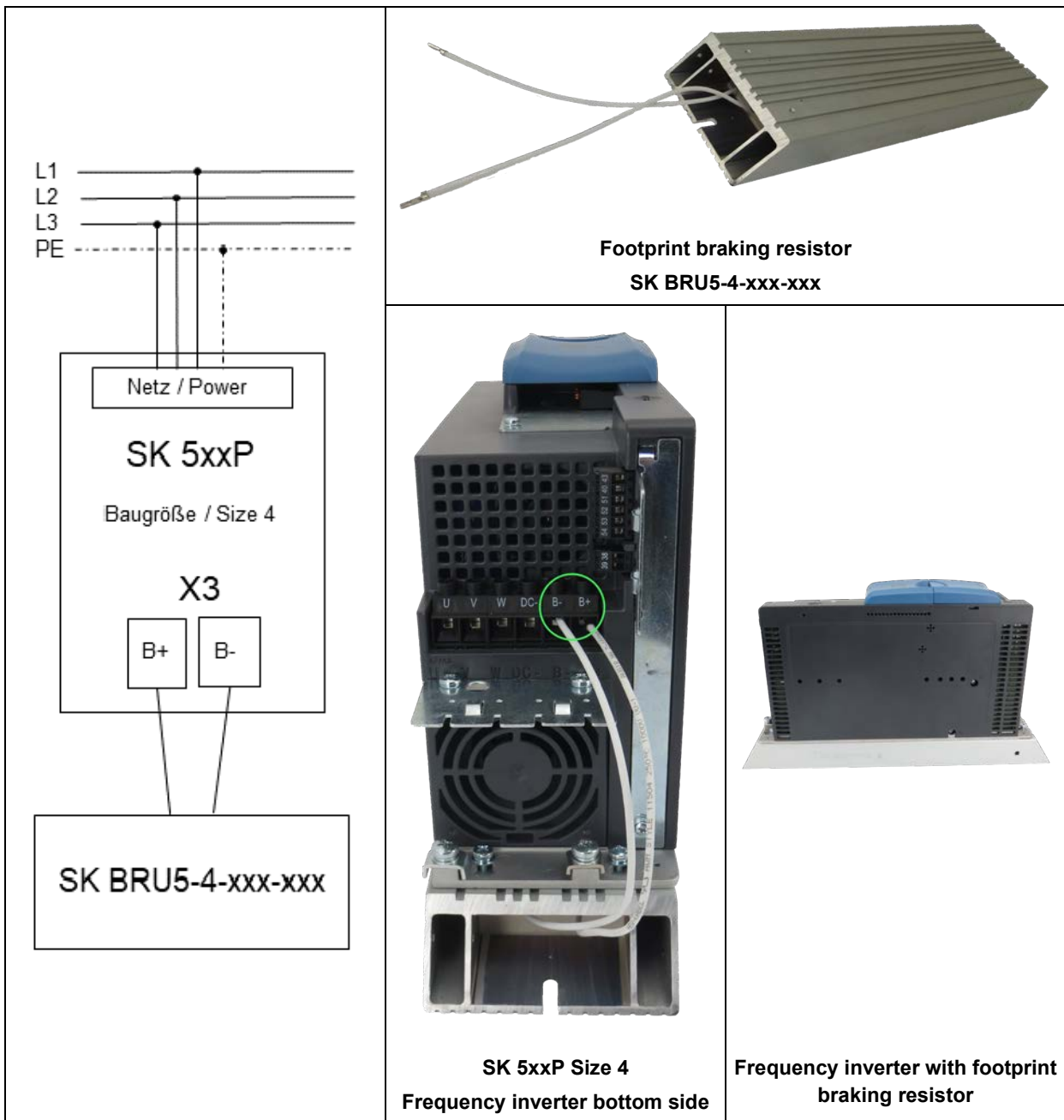

Further documentation and software [www.nord.com](http://www.nord.com)

Document	Designation
<a href="#">BU_0600</a>	Frequency inverter manual SK 500P – SK 550P

Document	Designation
<a href="#">F3060</a> <a href="#">E3000</a>	Flyer NORDAC PRO SK 500P